

2024-25



Manufacturer & Exporter Of
Plastic Surgery Instruments



PLASTIC SURGERY PLASTISCHE CHIRURGIE



: +92-321-6126225



: adas.surgical@gmail.com

ABOUT US

We Present this Catalogue with the aim of long life commitment and missionary dedication brought the Company, We acquired unblemished of reputation as manufacturers of complete range of **Surgical Instruments** as per standard set by international medical and surgical organizations.

We have come to specialize in instruments concerning **Surgical Surgery** or The two vital factors that can darken or illuminate the world of a patient are the dexterity of the surgeons hands & the precision of the instruments involved. As for as the accuracy of the instruments is concerned, we perform our part as conscientiously as is possible by the combination of human hands and the latest available technology.

Service to humanity comes first on our agenda, business and profit is the second.

From the procurement of raw materials to packing, all the phases of the process are conducted under the same roof. This ensures and facilitates our interference at any stage of the process, which makes it possible for us to achieve perfection. Our technical experts can achieve any degree of technicality, ranging from the slightest variations to complete redesigning and production of entirely new items.

The quality of raw materials is of the international standard, but we can also satisfy individual specifications selecting from a large variety of imported steel.

We also welcome enquires for the instruments not listed in this catalogue both in the **Surgical Instruments**









Inhalt | **Contenu**
Content | **Contenido**
Indice di catalogo

 <p>1</p>	<p>Skalpelle / Dermatome Scalpels / Dermatomes Bistouris / Dermatomes <i>Bisturíes / Dermatomos</i> Bisturi / Dermatomi</p>	<p>6 - 10</p>
 <p>2</p>	<p>Messinstrumente / Bleihände Measuring instruments / Leadhands Instruments pour mesurer / Mains en plomb <i>Instrumentos de medida / Manos de plomo</i> Strumenti di misurazione / Mani di piombo</p>	<p>11 - 12</p>
 <p>3</p>	<p>Scheren Scissors Ciseaux <i>Tijeras</i> Forbici</p>	<p>13 - 51</p>
 <p>4</p>	<p>Pinzetten Forceps Pinces <i>Pinzas</i> Pinze</p>	<p>52 - 65</p>
 <p>5</p>	<p>Approximatoren, Gefäßclips Approximators, vessel clips Approximateurs, clips <i>Approximadores, clips</i> Apressiamator, clips</p>	<p>66 - 69</p>
 <p>6</p>	<p>Arterienklemmen, Fasszangen / Gewebe- und Darmfasszangen / Tupfer- und Schwammzangen Haemostatic forceps / Tissue and intestinal holding forceps / Cotton swab forceps, sponge holding forceps Pince hémostatiques / Pincas intestinales et de tissue / Pincas à tampons et éponges <i>Pinzas hemostáticas / Pinzas para tejidos y intestinos / Pinzas para tampones y esponjas</i> Pinze emostatiche / Pinze per tessuti ed intestinali / Pinzer per tamponi</p>	<p>70 - 83</p>
 <p>7</p>	<p>Häkchen / Weichteilhaken für die Kieferchirurgie / Wundhaken-Wundsperrer Retractors / Soft tissue retractors for maxillo-facial surgery / Retractors-wound spreader, self-retaining Ecarteurs / Ecarteurs pour la chirurgie maxillo-faciale / Ecarteurs-écarteurs autostatiques <i>Separadores / Ganchos para cirugía maxilofacial / Separadores-separadores autoestáticos</i> Uncini / Uncini per chirurgia massilofaciale / Divaricatori-divaricatori autostatici</p>	<p>84 - 103</p>

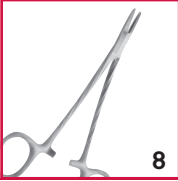
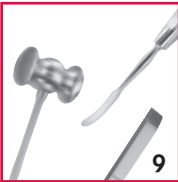

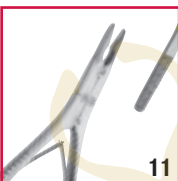
Inhalt Content	Contenu Contenido Indice di catalogo
---------------------------------	--

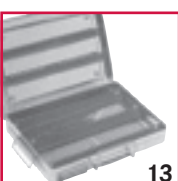
	Nadelhalter Needle holders Porte-aiguilles <i>Porta-agujas</i> Porta aghi	104 - 122
	Hämmer / Meißel / Elevatorien / Raspatorien Mallets / Chisels / Elevators / Periosteal elevators Maillets / Ostéotomes / Elevateurs / Rugines <i>Martillos / Cinceles / Elevadores / Periostótmos</i> Martelli / Scalpelli / Elevatori / Raspatori	123 - 139
	Nasenspekula / Nasensägen Nasal specula / Nasal saws Spéculums nasaux / Scies nasales <i>Éspeculos nasales / Sierras nasales</i> Specoli nasali / Seghe nasali	140 - 143
	Nasenraspeln / Septumzangen / Hohlmeißelzangen / Knochensplitterzangen Nasal rasps / Septum forceps / Bone rongeurs / Bone cutting forceps Râpes nasaux / Pincers pour la cloison nasale / Pince gouges / Pincers coupantes à os <i>Limas nasales / Pinzas para el tabique nasal / Pinzas gubias / Pinzas cortantes para huesos</i> Raspe nasali / Pinze per il setto nasale / Pinze sgorbie / Cesioie per ossa	144 - 157
	Tränenkanal-Dilatatoren / Knorpelquetscher Lacrimal dilators / Bone crusher Dilatateurs pour le canal lacrymal / Broyeur pour os <i>Dilatadores para el canal lacrimal / Prensa para huesos</i> Dilatatori lacrimali / Trittatore osseo	158 - 160
	Instrumenten-Kassetten / Grundinstrumentarium für die plastische Chirurgie Instrument trays / Basic set for plastic surgery Contenaires d'instrument / Set de base pour la chirurgie plastique <i>Cajas para instrumental / Juego de base para la cirugía plastica</i> Scatole per sterilizzazione / Set di base per la chirurgia plastica	161 - 163



Mikroklingen Halter – Mikroklingen
Micro-blade holder – Micro-blades

Porte micro-lames – Micro-lames
Porta para micro-hojas – Micro-hojas
Porta micro-lame – Micro-lame



1:1



1:1



1:1



1:1



1:1

Fig. 63	Fig. 64	Fig. 67	Fig. 69
AI 7121-03	AI 7121-04	AI 7121-07	AI 7121-09

Mikroklingen – Packung mit 25 Stück
Micro-Spare blade – package of 25 pieces
Micro-Lame de réchange – paquet de 25 pièces
Micro-Hoja de cambio – paquete de 25 piezas
Micro-Lame di ricambio – confezione da 25 pezzi

135 mm – 5¼ " "

AI 7120-13

Titan
Titanium
Titan
Titanio
Titanio



Die abgebildeten Klingen sind steril
The blades on this page are sterile
Les lames de cette page sont stériles
Los hojas de este pagina son esteriles
Le lame illustrate sono sterili



Skalpelle-Griffe
Scalpel handles

Manches de bistouri
Mangos de bisturí
Manici per bisturi



STANDARD

Fig. 3

AI7110-03

STANDARD

Fig. 4

AI7100-04

BARRON

Fig. 3

AI7113-03

Fig. 3 R

AI7115-03

Fig. 3 RG

AI7116-03

Fig. 7K

AI7110-71

Fig. 7

AI7110-07



Skalpellklingen | Lames de bistouris
Scalpel blades | *Hojas de bisturí*
| *Lame per bisturi*



Die abgebildeten Klingen sind steril
The blades on this page are sterile
Les lames de cette page sont stériles
Los hojas de este pagina son esteriles
Le lame illustrate sono sterili

Packung mit 100 Stück

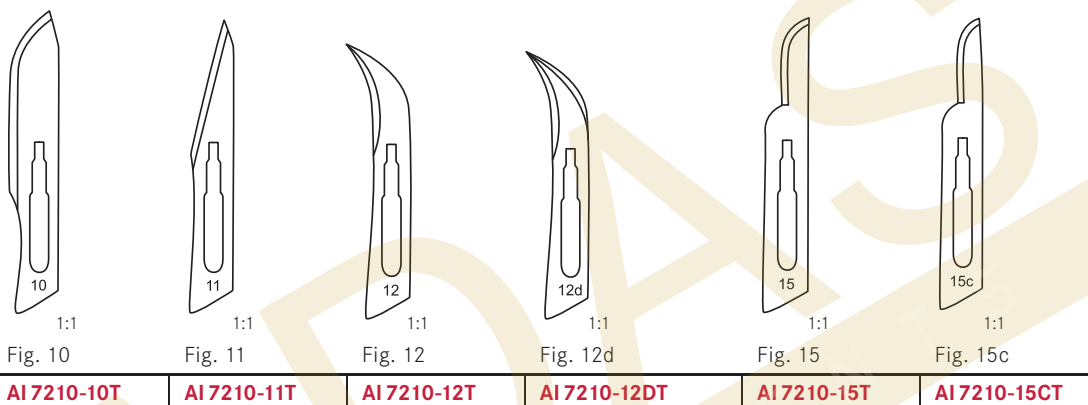

doppelschneidend
double cutting edge
double tranchante
corta doble
a doppio taglio

passend für Griffe: AI 7110-03, AI 7111-03, AI 7110-07, AI 7110-71, AI 7112-03, AI 7113-03, AI 7115-03, AI 7116-03
for handles: AI 7110-03, AI 7111-03, AI 7110-07, AI 7110-71, AI 7112-03, tk7113-03, AI 7115-03, AI 7116-03
pour manches: AI 7110-03, AI 7111-03, AI 7110-07, AI 7110-71, AI 7112-03, AI 7113-03, AI 7115-03, AI 7116-03
para mangos: AI 7110-03, AI 7111-03, AI 7110-07, AI 7110-71, AI 7112-03, AI 7113-03, AI 7115-03, AI 7116-03
per manici: AI 7110-03, AI 7111-03, AI 7110-07, AI 7110-71, AI 7112-03, AI 7113-03, AI 7115-03, AI 7116-03

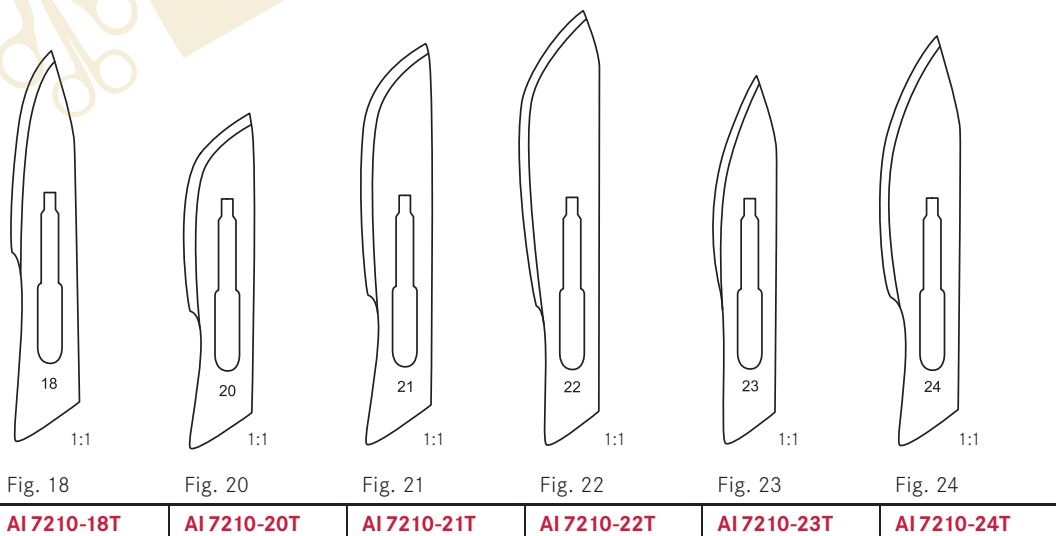

passend für Griffe: AI 7100-04, AI 7101-04, AI 7102-04, AI 7105-08
for handles: AI 7100-04, AI 7101-04, AI 7102-04, AI 7105-08
pour manches: AI 7100-04, AI 7101-04, AI 7102-04, AI 7105-08
para mangos: AI 7100-04, AI 7101-04, AI 7102-04, AI 7105-08
per manici: AI 7100-04, AI 7101-04, AI 7102-04, AI 7105-08



Dermatome | Dermatomes
Dermatomes | *Dermatomos*
Dermatomi



1:2

TIERSCH

200 mm - 8"

AI 7890-20



1:2

SCHINK

AI 7900-00 | 300 mm - 12"

komplett mit 1 Klinge und 2 Spannhaltern
complete with 1 blade and 2 plates
complet avec 1 lame et 2 plaques
completo con 1 hoja y 2 placas
completo con 1 lama e 2 placche



1:2

AI 7901-00

Ersatzklinge
spare blade
lame de rechange
hoja de cambio
lama di ricambio



1:2

SCHINK

AI 7902-00

Spannplatte
Skin fixing plate
Plaque pour tendre la peau
Placa para extender la piel
Placca per stendere la pelle



Dermatome
Dermatomes

Dermatomes
Dermatomos
Dermatomi

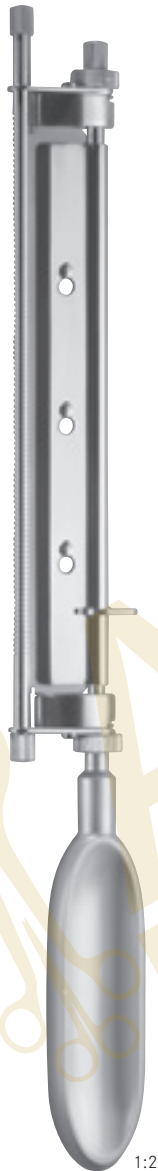

1:2

HUMBY

310 mm - 12 1/4"

AI 7905-00

komplett mit 1 Klinge
complete with 1 blade
complet avec 1 lame
completo con 1 hoja
completo con 1 lama



1:2

AI 7908-00

Ersatzklinge für ai7905-00, ai7907-00
spare blade for ai7905-00, ai7907-00

lame de rechange pour ai7905-00, ai7907-00
hoja de cambio para ai7905-00, ai7907-00
lama di ricambio per ai7905-00, ai7907-00



1:2

WATSON

300 mm - 12"

AI 7907-00

komplett mit 1 Klinge, Stange starr
complete with 1 blade, fixed bar
complet avec 1 lame, tige fix
completo con 1 hoja, barra fijada
completo con 1 lama, barra fissa



Messinstrumente
Measuring instruments

 Instruments à mesurer
Instrumentos de medida
 Strumenti per la misurazione

Ø = 32 mm	Ø = 37 mm	Ø = 43 mm
AI 4664-01	AI 4664-02	AI 4664-03

Mamillenringe (stumpf)
Areola markers (blunt)
 Marqueurs pour l'aréole (mousses)
Marcadores para aréola (romos)
 Marcatori per areola (smussati)

FREEMAN

Ø = 34 mm	Ø = 36 mm	Ø = 38 mm	Ø = 42 mm	Ø = 45 mm	Ø = 50 mm
AI 4664-04	AI 4664-05	AI 4664-06	AI 4664-07	AI 4664-08	AI 4664-09

Mamillenringe (stumpf)
Areola markers (blunt)
 Marqueurs pour l'aréole (mousses)
Marcadores para aréola (romos)
 Marcatori per areola (smussati)

CHANG

Ø = 38/42 mm

AI 4664-10

Mamillerring (stumpf)
Areola marker (blunt)
 Marqueur pour l'aréole (mousses)
Marcador para aréola (romos)
 Marcatore per areola (smussati)

GROSSMAN

Ø = 48/52 mm

AI 4664-11

Mamillerring (stumpf)
Areola marker (blunt)
 Marqueur pour l'aréole (mousses)
Marcador para aréola (romos)
 Marcatore per areola (smussati)

Für präzises Markieren der Brustwarze bei:

- kombinierter Bruststraffung
- Verkleinerung des Brustwarzenhofes

For precise marking of the nipple during:

- combined breast-lifting
- reduction of the areola

Pour marquage exact du mamelon en cas de:

- lifting des seins combiné
- réduction de l'aréole

Para la marcación precisa del pezón en caso de:

- combinación con un lifting de la mama
- reducción del tamaño de la areola mamaria

Per la marcatura esatta del capezzolo in caso di:

- rassodamento combinato della mammella
- riduzione del complesso areola-capezzolo

100 mm - 4"	AI 4651-10
150 mm - 6"	AI 4651-15
200 mm - 8"	AI 4651-20
300 mm - 12"	AI 4651-30
500 mm - 20"	AI 4651-50



Bleihände
Leadhands

Mains en plomb
Manos de plomo
Mano di piombo



AI48180-01

für Kinder
child size
pour enfants
para niños
per bambini

AI48180-02

für Erwachsene
adult size
pour adultes
para adultos
per adulti

AI48180-03

für Erwachsene, mit Silikonüberzug
adult size with silicone coating
pour adultes, avec couche de silicone
para adultos, con cubierta de silicon
per adulti, rivestito di silicone

AI48180-04

für Kinder, mit Silikonüberzug
child size with silicone coating
pour enfants, avec couche de silicone
para niños, con cubierta de silicon
per bambini, rivestito di silicone



Technische Informationen

 Information technique
 Información técnica
 Informazione tecnica

 **Standard Cut**

Hochwertige Scheren mit Standardschliff

High performance scissors with standard cutting edges

Ciseaux de haute qualité avec coupe standard

Tijeras de alta calidad con afiladura estándar

Forbici di altissima qualità con filettatura standard

 **SuperCut**

Osteotomschliff und Mikroverzahnung

Präzises Präparieren und minimal traumatisierender Schnitt

Osteotom edges and micro serration

Precise dissection and minimal traumatizing cut

Coupe ostéotome et dentelure micro

Dissection précise et minimal traumatisante

Corte osteotomo y dentado micro
Dissección precisa mínima traumática

Affilatura a forma di osteotomo e dentellatura micro

Dissezione precisa e taglio minimamente traumatizzante

 **TC Cut**

Eingeschweisste Hartmetallschneiden mit Standardschliff

Lange Schnitthaltigkeit

Welded tungsten-carbide cutting edges

Long lasting cutting ability

Plaques en carbure de tungstène soudées dans les lames

Qualité de coupe continue

Placas de carburo de tungsteno soldadas en las hojas
Calidad de corte permanente

Lame saldate al carburo di tungsteno con filettatura standard

Lunga durata di taglio





Scheren | Ciseaux
Tijeras
Forbici



METZENBAUM

STANDARD		
140 mm - 5½"	AI 8323-14-A	AI 8333-14-A
150 mm - 6"		AI 8353-15-A
180 mm - 8"	AI 8343-18-A	AI 8353-18-A
200 mm - 8"	AI 8343-20-A	AI 8353-20-A
230 mm - 9"		AI 8353-23-A

SUPERCUT		
140 mm - 5½"	AI 8323-14-B	AI 8333-14-B
150 mm - 6"		AI 8353-15-B
180 mm - 8"	AI 8343-18-B	AI 8353-18-B
200 mm - 8"	AI 8343-20-B	AI 8353-20-B
230 mm - 9"		AI 8353-23-B

TC CUT		
140 mm - 5½"	AI 8323-14-C	AI 8333-14-C
180 mm - 8"	AI 8343-18-C	AI 8353-18-C
200 mm - 8"	AI 8343-20-C	AI 8353-20-C
230 mm - 9"		AI 8353-23-C

CERAMIC SUPERCUT		
140 mm - 5½"	AI 8323-14-E	AI 8333-14-E
180 mm - 8"	AI 8343-18-E	AI 8353-18-E
200 mm - 8"	AI 8343-20-E	AI 8353-20-E
230 mm - 9"		AI 8353-23-E
250 mm - 9¾"		AI 8353-25-E

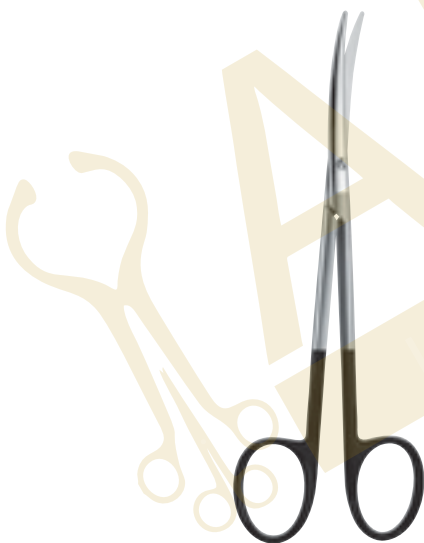

Scheren | Ciseaux
 Scissors | Tijeras
 | Forbici



1:1

METZENBAUM FINO

<input type="checkbox"/>	STANDARD	
	140 mm - 5½"	AI 8373-14-A
	180 mm - 8"	AI 8381-18-A
	200 mm - 8"	AI 8381-20-A
<input checked="" type="checkbox"/>	SUPERCUT	
	140 mm - 5½"	AI 8373-14-B
	180 mm - 8"	AI 8381-18-B
	200 mm - 8"	AI 8381-20-B
<input checked="" type="checkbox"/>	TC CUT	
	140 mm - 5½"	AI 8373-14-C
	180 mm - 8"	AI 8381-18-C
	200 mm - 8"	AI 8381-20-C
<input checked="" type="checkbox"/>	TC SUPERCUT	
	180 mm - 8"	AI 8381-18-D
<input checked="" type="checkbox"/>	CERAMIC SUPERCUT	
	140 mm - 5½"	AI 8373-14-E
	180 mm - 8"	AI 8381-18-E
	200 mm - 8"	AI 8381-20-E



1:1

BABY METZENBAUM

<input type="checkbox"/>	STANDARD	
	115 mm - 4½"	AI 8333-11-A
<input checked="" type="checkbox"/>	SUPERCUT	
	115 mm - 4½"	AI 8333-11-B
<input checked="" type="checkbox"/>	TC CUT	
	115 mm - 4½"	AI 8333-11-C
<input checked="" type="checkbox"/>	TC SUPERCUT	
	115 mm - 4½"	AI 8333-11-D
<input checked="" type="checkbox"/>	CERAMIC SUPERCUT	
	115 mm - 4½"	AI 8333-11-E



1:2



Scheren | Ciseaux
Scissors | Tijeras
Forbici



1:2



1:1

LEXER

<input type="checkbox"/> STANDARD	
160 mm - 6¼"	AI 8123-16-A
<input checked="" type="checkbox"/> SUPERCUT	
160 mm - 6¼"	AI 8123-16-B
<input checked="" type="checkbox"/> TC CUT	
160 mm - 6¼"	AI 8123-16-C
<input checked="" type="checkbox"/> TC SUPERCUT	
160 mm - 6¼"	AI 8123-16-D
<input checked="" type="checkbox"/> CERAMIC SUPERCUT	
160 mm - 6¼"	AI 8123-16-E



1:2



1:1

MAYO LEXER

<input checked="" type="checkbox"/> TC CUT	
165 mm - 6½"	AI 8125-16-C
<input checked="" type="checkbox"/> TC SUPERCUT	
165 mm - 6½"	AI 8125-16-D
<input checked="" type="checkbox"/> CERAMIC SUPERCUT	
165 mm - 6½"	AI 8125-16-E



Scheren | Ciseaux
Scissors | Tijeras
Forbici



MAYO STILLE

<input type="checkbox"/> STANDARD	
170 mm - 6¾"	AI 8283-17-A
<input checked="" type="checkbox"/> SUPERCUT	
170 mm - 6¾"	AI 8283-17-B
<input checked="" type="checkbox"/> TC CUT	
170 mm - 6¾"	AI 8283-17-C
<input checked="" type="checkbox"/> TC SUPERCUT	
170 mm - 6¾"	AI 8283-17-D
<input checked="" type="checkbox"/> CERAMIC SUPERCUT	
170 mm - 6¾"	AI 8283-17-E



REYNOLDS

<input type="checkbox"/> STANDARD	
140 mm - 5½"	AI 8603-14-A
160 mm - 6¼"	AI 8603-16-A
<input checked="" type="checkbox"/> CERAMIC SUPERCUT	
160 mm - 6¼"	AI 8603-16-E



Scheren | Ciseaux
Scissors | Tijeras
Forbici



1:2

JOSEPH

<input type="checkbox"/> STANDARD	
150 mm - 6"	AI 8693-14-A
<input checked="" type="checkbox"/> SUPERCUT	
150 mm - 6"	AI 8693-14-B



1:1



1:2

KELLY

<input type="checkbox"/> STANDARD	
160 mm - 6¼"	AI 8463-16-A
<input checked="" type="checkbox"/> SUPERCUT	
160 mm - 6¼"	AI 8463-16-B
<input checked="" type="checkbox"/> TC CUT	
160 mm - 6¼"	AI 8463-16-C
<input checked="" type="checkbox"/> TC SUPERCUT	
160 mm - 6¼"	AI 8463-16-D
<input checked="" type="checkbox"/> CERAMIC SUPERCUT	
160 mm - 6¼"	AI 8463-16-E



1:1



Scheren | Ciseaux
Scissors | Tijeras
Forbici



1:2



1:1

STEVENS

<input type="checkbox"/> STANDARD	
130 mm - 5"	AI 8463-13-A
<input checked="" type="checkbox"/> SUPERCUT	
130 mm - 5"	AI 8463-13-B

stumpf
blunt
mousses
roma
smusse



1:2



1:1

IRIS

<input checked="" type="checkbox"/> SUPERCUT	
115 mm - 4½"	AI 9434-11-B
<input checked="" type="checkbox"/> TC SUPERCUT	
115 mm - 4½"	AI 9434-11-C

spitz
sharp
pointue
aguda
acuta



Technische Informationen
Technical information

Information technique
Información técnica
Informazione tecnica

140 mm - 5/8	AI 8198-14	AI 9198-14
140 mm - 5/8	AI 8198-14 SU	AI 9198-14 SU
140 mm - 5/8	AI 8198-14 SUB	AI 9198-14 SUB
140 mm - 5/8	AI 8193-14 TC	AI 9193-14 TC
140 mm - 5/8	AI 8197-14	AI 9197-14 SU TC
	gerade straight droits	gebogen curved courbes



standard

Scheren aus rostfreiem Stahl mit Standardschliff für präzises Arbeiten.
Stainless steel scissors with standard cut for precise working.
Ciseaux d'acier inoxydable avec coupe standard pour des travaux précis.
Tijeras de acero inoxidable con corte standard para un trabajo preciso.
Forbici di acciaio inossidabile con filatura Standard per tagli precisi.



super cut

Messerschliff und Mikroverzahnung für einen feinen minimal traumatisierenden Schnitt.
Knife edges and micro serration for a fine and minimally traumatizing cut.
Aiguisement tranchante et dents micro pour une coupe fine, peu traumatisante.
Hoja de bisturí y dentadura micro para un corte fino, mínimo traumatizante.
Affilatura a scalpello e dentellatura micro per uno taglio fine, minimo traumatizzante.



**super cut
black handle**

SuperCut Scheren mit schwarzen Griffen.
SuperCut scissors with black handles.
Ciseaux SuperCut avec anneaux noirs
Tijeras SuperCut con anillos negros
Forbici SuperCut con anelli neri

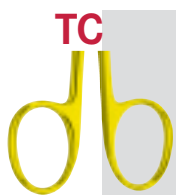

tungsten carbide

Nahtlos aufgeschweisste, korrosionsfreie Hartmetallschneiden.
Seamless welded, corrosion-free tungsten carbide cutting edges.
Plaques en carbure de tungstène, non-corrosives, soudées homogènement dans les lames.
Placas de carburo de tungsteno soldadas homogéneamente y anticorrosiva en las hojas.
Congiunzione omogenea senza cordolo lame saldate al carburo di tungsteno.



**super cut
tungsten carbide**

Nahtlos aufgeschweisste Hartmetallschneide mit Messerschliff und Mikroverzahnung
Tungsten carbide plates, seamlessly welded into the jaws. Knife edges and micro serration.
Plaques en carbure de tungstène, soudées homogènement das les lames. Aiguisement trachante et dents micro.
Placas de carburo de tungsteno soldadas homogéneamente y en las hojas. Hoja de bisturí y dentura micro.
Lame con taglio in tungsteno, senza saldature del morso, con taglio delle lame e dentatura micro.



Chirurgische Scheren
Operating scissors

Ciseaux à chirurgie
Tijeras para cirugía
Forbici per chirurgia



MAYO

145 mm - 5 $\frac{3}{4}$ "	AI 8272-14	AI 8273-14
150 mm - 6 $\frac{3}{4}$ "	AI 8272-15	AI 8273-15
170 mm - 6 $\frac{3}{4}$ "	AI 8272-17	AI 8273-17
230 mm - 9"	AI 8272-23	AI 8273-23
145 mm - 5 $\frac{3}{4}$ "	AI 8272-14 SU	AI 8273-14 SU
150 mm - 6 $\frac{3}{4}$ "	AI 8272-15 SU	AI 8273-15 SU
170 mm - 6 $\frac{3}{4}$ "	AI 8272-17 SU	AI 8273-17 SU
230 mm - 9"	AI 8272-23 SU	AI 8273-23 SU
145 mm - 5 $\frac{3}{4}$ "	AI 8272-14 SUB	AI 8273-14 SUB
150 mm - 6 $\frac{3}{4}$ "	AI 8272-15 SUB	AI 8273-15 SUB
170 mm - 6 $\frac{3}{4}$ "	AI 8272-17 SUB	AI 8273-17 SUB
230 mm - 9"	AI 8272-23 SUB	AI 8273-23 SUB
145 mm - 5 $\frac{3}{4}$ "	AI 8278-14 TC	AI 8279-14 TC
170 mm - 6 $\frac{3}{4}$ "	AI 8278-17 TC	AI 8279-17 TC
230 mm - 9"	AI 8278-23 TC	AI 8279-23 TC



Chirurgische Scheren
Operating scissors

Ciseaux à chirurgie
Tijeras para cirugía
Forbici per chirurgia



Fig. 1



Fig. 2

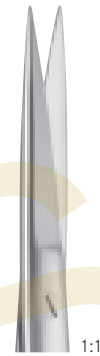

Fig. 3

120 mm - 4 $\frac{3}{4}$ "	AI 8523-12	AI 8524-12	AI 8525-12
----------------------------	-------------------	-------------------	-------------------



Fig. 1



Fig. 2

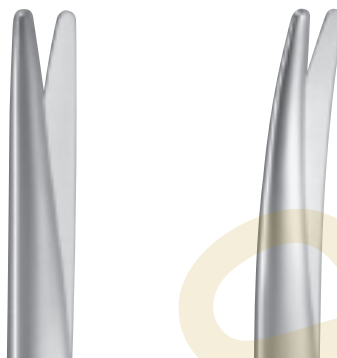

Fig. 3

120 mm - 4 $\frac{3}{4}$ "	AI 8533-12	AI 8534-12	AI 8535-12
----------------------------	-------------------	-------------------	-------------------



Chirurgische Scheren
 Operating scissors

 Ciseaux à chirurgie
Tijeras para cirugía
 Forbici per chirurgia

LEXER

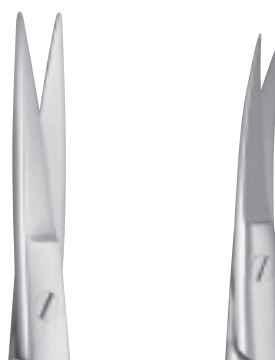
160 mm - 6 $\frac{1}{4}$ "	AI 8122-16	AI 8123-16
210 mm - 8 $\frac{1}{4}$ "	AI 8122-21	AI 8123-21
160 mm - 6 $\frac{1}{4}$ "	AI 8122-16 SU	AI 8123-16 SU
160 mm - 6 $\frac{1}{4}$ "	AI 8122-16 SUB	AI 8123-16 SUB
160 mm - 6 $\frac{1}{4}$ "	AI 8138-16 TC	AI 8139-16 TC

KELLY

160 mm - 6 $\frac{1}{4}$ "	AI 8462-16	AI 8463-16
180 mm - 7"	AI 8462-18	AI 8463-18

 Fistel Scheren
 Fistula scissors
 Ciseaux pour fistules
Tijeras para fistulas
 Forbici per fistole



Chirurgische Scheren | Ciseaux à chirurgie
 Operating scissors | Tijeras para cirugía
 Forbici per chirurgia



1:2

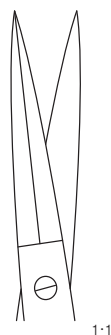

1:1



1:1

PECK-JOSEF

140 mm - 5½"	AI 8198-14	AI 9198-14
140 mm - 5½"	AI 8198-14 SU	AI 9198-14 SU
140 mm - 5½"	AI 8198-14 SUB	AI 9198-14 SUB
140 mm - 5½"	AI 8193-14 TC	AI 9193-14 TC
140 mm - 5½"	AI 8197-14 SU TC	AI 9197-14 SU TC



1:2



1:1



1:1

BROPHY (SULLIVAN)

145 mm - 5¾"	AI 8572-14	AI 8573-14
--------------	-------------------	-------------------



Chirurgische Scheren – Präparierscheren
Operating scissors – Dissecting scissors

Ciseaux à chirurgie – Ciseaux à dissection
Tijeras para cirugía – Tijeras de disección
Forbici per chirurgia – Forbici per dissezione



METZENBAUM-NELSON

	Fig. 1	Fig. 2	Fig. 3
115 mm – 4½"	AI 8323-11		
145 mm – 5¾"	AI 8323-14	AI 8324-14	AI 8325-14
150 mm – 6"	AI 8343-15		
180 mm – 7"	AI 8343-18	AI 8344-18	AI 8345-18
200 mm – 8"	AI 8343-20	AI 8344-20	AI 8345-20
230 mm – 9"	AI 8343-23	AI 8344-23	AI 8345-23
250 mm – 9¾"	AI 8343-25	AI 8344-25	AI 8345-25
280 mm – 11"	AI 8343-28	AI 8344-28	AI 8345-28
300 mm – 12"	AI 8343-30	AI 8344-30	AI 8345-30
145 mm – 5¾"	AI 8323-14 SU		
180 mm – 7"	AI 8343-18 SU		
200 mm – 8"	AI 8343-20 SU		
230 mm – 9"	AI 8343-23 SU		
145 mm – 5¾"	AI 8323-14 SUB		
180 mm – 7"	AI 8343-18 SUB		
200 mm – 8"	AI 8343-20 SUB		
230 mm – 9"	AI 8343-23 SUB		
115 mm – 4½"	AI 8327-11 TC		
145 mm – 5¾"	AI 8327-14 TC	AI 8328-14 TC	AI 8329-14 TC
180 mm – 7"	AI 8347-18 TC	AI 8348-18 TC	AI 8349-18 TC
200 mm – 8"	AI 8347-20 TC	AI 8348-20 TC	AI 8349-20 TC
230 mm – 9"	AI 8347-23 TC	AI 8348-23 TC	AI 8349-23 TC
250 mm – 9¾"	AI 8347-25 TC		
280 mm – 11"	AI 8347-28 TC		
300 mm – 12"	AI 8347-30 TC		



Chirurgische Scheren – Präparierscheren
Operating scissors – Dissecting scissors

Ciseaux à chirurgie – Ciseaux à dissection
Tijeras para cirugía – Tijeras de disección
Forbici per chirurgia – Forbici per dissezione



METZENBAUM-NELSON

	Fig. 1	Fig. 2	Fig. 3
115 mm – 4½"	AI 8333-11		
145 mm – 5¾"	AI 8333-14	AI 8334-14	AI 8335-14
150 mm – 6"	AI 8353-15		
180 mm – 7"	AI 8353-18	AI 8354-18	AI 8356-18
200 mm – 8"	AI 8353-20	AI 8354-20	AI 8356-20
230 mm – 9"	AI 8353-23	AI 8354-23	AI 8356-23
250 mm – 9¾"	AI 8353-25	AI 8354-25	AI 8356-25
280 mm – 11"	AI 8353-28	AI 8354-28	AI 8356-28
300 mm – 12"	AI 8353-30	AI 8354-30	AI 8356-30
145 mm – 5¾"	AI 8333-14 SU		
180 mm – 7"	AI 8353-18 SU		
200 mm – 8"	AI 8353-20 SU		
230 mm – 9"	AI 8353-23 SU		
145 mm – 5¾"	AI 8333-14 SUB		
180 mm – 7"	AI 8353-18 SUB		
200 mm – 8"	AI 8353-20 SUB		
230 mm – 9"	AI 8353-23 SUB		
115 mm – 4½"	AI 8337-11 TC		
145 mm – 5¾"	AI 8337-14 TC	AI 8338-14 TC	AI 8339-14 TC
180 mm – 7"	AI 8357-18 TC	AI 8358-18 TC	AI 8359-18 TC
200 mm – 8"	AI 8357-20 TC	AI 8358-20 TC	AI 8359-20 TC
230 mm – 9"	AI 8357-23 TC	AI 8358-23 TC	AI 8359-23 TC
250 mm – 9¾"	AI 8357-25 TC		
280 mm – 11"	AI 8357-28 TC		
300 mm – 12"	AI 8357-30 TC		



Chirurgische Scheren – Präparierscheren
Operating scissors – Dissecting scissors

Ciseaux à chirurgie – Ciseaux à dissection
Tijeras para cirugía – Tijeras de disección
Forbici per chirurgia – Forbici per dissezione



METZENBAUM-FINO

	Fig. 1	Fig. 3	Fig. 1	Fig. 3
145 mm – 5¾"	AI 8372-14	AI 8374-14	AI 8373-14	AI 8375-14
180 mm – 7"	AI 8380-18		AI 8381-18	
200 mm – 8"	AI 8380-20		AI 8381-20	
230 mm – 9"	AI 8380-23		AI 8381-23	
<hr/>				
145 mm – 5¾"	AI 8372-14 SU		AI 8373-14 SU	
180 mm – 7"	AI 8380-18 SU		AI 8381-18 SU	
200 mm – 8"	AI 8380-20 SU		AI 8381-20 SU	
230 mm – 9"	AI 8380-23 SU		AI 8381-23 SU	
<hr/>				
145 mm – 5¾"	AI 8372-14 SUB		AI 8373-14 SUB	
180 mm – 7"	AI 8380-18 SUB		AI 8381-18 SUB	
200 mm – 8"	AI 8380-20 SUB		AI 8381-20 SUB	
230 mm – 9"	AI 8380-23 SUB		AI 8381-23 SUB	
<hr/>				
145 mm – 5¾"	AI 8363-14 TC	AI 8366-14 TC	AI 8365-14 TC	AI 8367-14 TC
180 mm – 7"	AI 8370-18 TC		AI 8371-18 TC	
200 mm – 8"	AI 8370-20 TC		AI 8371-20 TC	
230 mm – 9"	AI 8370-23 TC		AI 8371-23 TC	



Irisscheren | Ciseaux à iridectomie
iris scissors | Tijeras para iridectomia
 Forbici per iridectomia

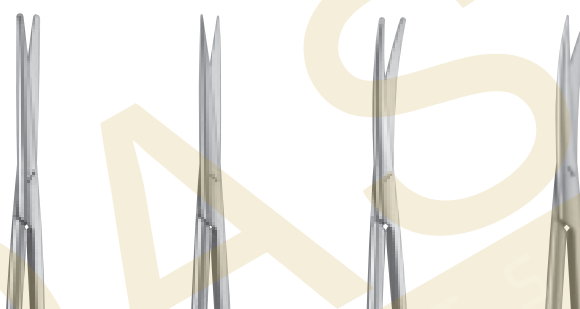

90 mm - 3½"	AI 8642-09	AI 8643-09
115 mm - 4½"	AI 8632-11	AI 8633-11
115 mm - 4½"	AI 8636-11 TC	AI 8637-11 TC



90 mm - 3½"	AI 8652-09	AI 8653-09
100 mm - 4"	AI 8652-10	AI 8653-10
115 mm - 4½"	AI 8652-11	AI 8653-11
100 mm - 4"	AI 8652-10 SU	AI 8653-10 SU
100 mm - 4"	AI 8652-10 SUB	AI 8653-10 SUB



Feine Scheren
Fine scissors

Ciseaux fins
Tijeras finas
Forbici fini



1:2



1:1



1:1

STRABISMUS-SCHERE

115 mm - 4½"	AI 9482-11	AI 9483-11
115 mm - 4½"	AI 9482-11 SU	AI 9483-11 SU
115 mm - 4½"	AI 9482-11 SUB	AI 9483-11 SUB



1:2



1:1

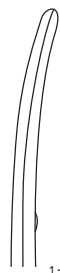

1:1

KNAPP

105 mm - 4¼"	AI 8688-10	AI 8689-10
--------------	-------------------	-------------------

stumpf
blunt
mousse
aguda
smusse



1:2

GRADLE

90 mm - 3¾"	AI 8694-09
-------------	-------------------

gebogen, spitz
curved, pointed
courbes, pointue
curva, aguda
curve, acuta



Feine Scheren | Ciseaux fins
Fine scissors | Tijeras finas
Forbici fini



QUINBY
125 mm - 5" | **AI 8592-12**



1:1

1:2



NEUMANN
120 mm - 4 3/4" | **AI 8597-12**

S-förmig gebogen
S curved
courbe en S
curva en S
curve a forma di S

1:2

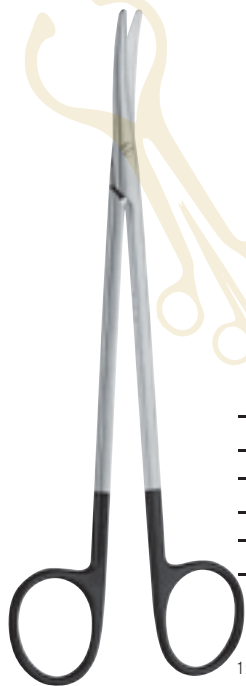

MC INDOE
180 mm - 7" | **AI 8352-18**

180 mm - 7" | **AI 8352-18 SU**

180 mm - 7" | **AI 8352-18 SUB**



1:2

1:2

Kurzes Maul
Short jaw
Mors court
Boca corta
Taglio corto

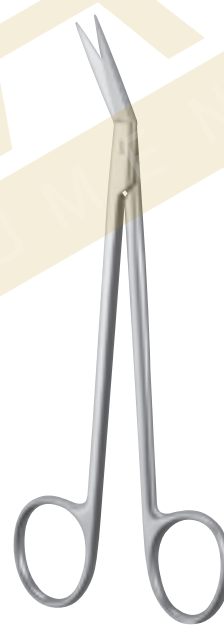

LOCKLIN
165 mm - 6 1/2" | **AI 8582-16** | **AI 8587-16**

gerade, gezahnt
straight, saw edge
droit, dentelée
recta, dentata
rette, dentate

gebogen, gezahnt
curved, saw edge
courbe, dentelée
curva, dentata
curve, dentate

1:2



Feine chirurgische Scheren
Fine operating scissors

Ciseaux fins à chirurgie
Tijeras finas para cirugía
Forbici fine per chirurgia



CONVERSE

100 mm - 3 3/4"

AI9203-10

aufgewinkelt
angled
courbe vers le haut
angulado
angulato

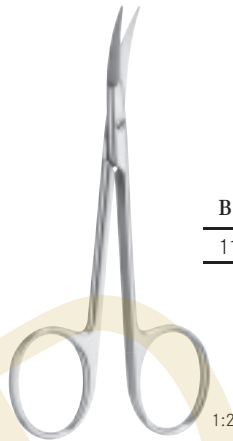

BEUSE

115 mm - 5"

AI9206-11

AI9207-11

leicht gebogen, spitz
slightly curved, pointed
légèrement courbe,
pointues
ligeramente curva, aguda
legeramente curve, acuta

leicht gebogen, stumpf
slightly curved, blunt
légèrement courbe,
mousses
ligeramente curva, roma
legeramente curve, smusso

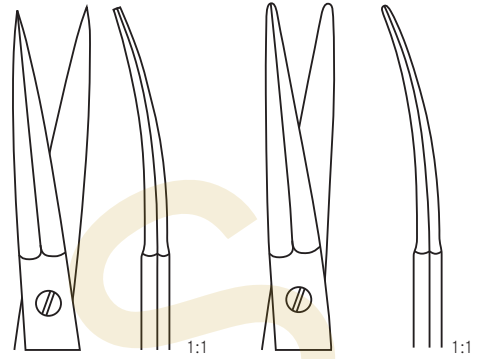

RIBBON STEVENS

95 mm - 3 3/4"

AI9456-10

AI9454-10

spitz - spitz
sharp - sharp
pointue - pointue
aguda - aguda
acuta - acuta

RIBBON STEVENS

95 mm - 3 3/4"

AI9457-10

AI9455-10

stumpf - stumpf
blunt - blunt
mousse - mousse
roma - roma
smussa - smussa





Sehnenscheren | Ciseaux à ténatomie
Tenotomy scissors | Tijeras para tenotomia
 Forbici per tenotomia



STEVENS

100 mm - 4"	AI9452-10	AI9453-10
110 mm - 4 1/4"	AI9452-11	AI9453-11
100 mm - 4"	AI9452-10 SU	AI9453-10 SU
110 mm - 4 1/4"	AI9452-11 SU	AI9453-11 SU
100 mm - 4"	AI9452-10 SUB	AI9453-10 SUB
110 mm - 4 1/4"	AI9452-11 SUB	AI9453-11 SUB

spitz - spitz
 sharp - sharp
 pointue - pointue
 aguda - aguda
 acuta - acuta



STEVENS

100 mm - 4"	AI9462-10	AI9463-10
110 mm - 4 1/4"	AI9462-11	AI9463-11
100 mm - 4"		AI9463-10 SU
110 mm - 4 1/4"		AI9463-11 SU
100 mm - 4"		AI9463-10 SUB
110 mm - 4 1/4"		AI9463-11 SUB

stumpf - stumpf
 blunt - blunt
 mousse - mousse
 roma - roma
 smussa - smussa



Scheren für plastische Operationen
Plastic surgery scissors

Ciseaux pour la chirurgie plastique
Tijeras para cirugía plástica
Forbici per chirurgia plastica

REYNOLDS (JAMESON)

160 mm - 6 $\frac{1}{4}$ "	AI 8602-16	AI 8603-16
180 mm - 7"	AI 8602-18	AI 8603-18
160 mm - 6 $\frac{1}{4}$ "	AI 8602-16 SU	AI 8603-16 SU
180 mm - 7"	AI 8602-18 SU	AI 8603-18 SU
160 mm - 6 $\frac{1}{4}$ "	AI 8602-16 SUB	AI 8603-16 SUB
180 mm - 7"	AI 8602-18 SUB	AI 8603-18 SUB

KILNER (RAGNELL)

120 mm - 4 $\frac{3}{4}$ "	AI 8697-12
150 mm - 6"	AI 8697-15
120 mm - 4 $\frac{3}{4}$ "	AI 8697-12 SU
150 mm - 6"	AI 8697-15 SU
180 mm - 7"	AI 8697-18 SU
200 mm - 8"	AI 8697-20 SU
120 mm - 4 $\frac{3}{4}$ "	AI 8697-12 SUB
150 mm - 6"	AI 8697-15 SUB
180 mm - 7"	AI 8697-18 SUB
200 mm - 8"	AI 8697-20 SUB
120 mm - 4 $\frac{3}{4}$ "	AI 8698-12 TC
150 mm - 6"	AI 8698-15 TC



Scheren für plastische Operationen
Plastic surgery scissors

Ciseaux pour la chirurgie plastique
Tijeras para cirugía plástica
Forbici per chirurgia plastica



1:2



1:1



1:1

JOSEPH

140 mm - 5½"	AI 8692-14	AI 8693-14
--------------	-------------------	-------------------

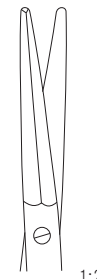

1:2



1:2

GORNEY

180 mm - 7¼"	AI 8704-18 SU	AI 8705-18 SU
230 mm - 9"	AI 8704-23 SU	AI 8705-23 SU
180 mm - 7¼"	AI 8704-18 SUB	AI 8705-18 SUB
230 mm - 9"	AI 8704-23 SUB	AI 8705-23 SUB
190 mm - 7½"	AI 8702-20 TC	AI 8703-20 TC
230 mm - 9"	AI 8702-23 TC	AI 8703-23 TC



Scheren für plastische Operationen
Plastic surgery scissors

Ciseaux pour la chirurgie plastique
Tijeras para cirugía plástica
Forbici per chirurgia plastica

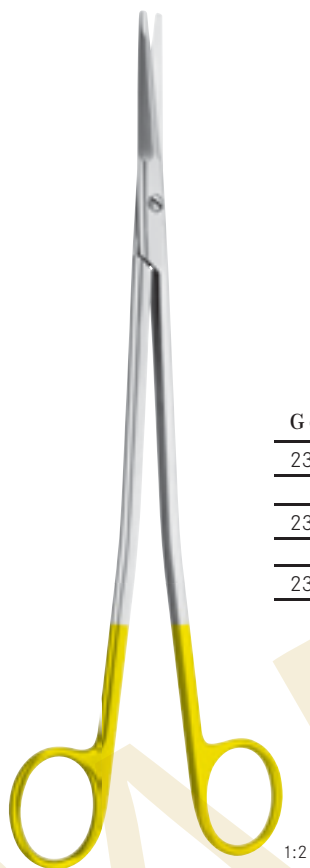

GORNEY PLATYSMA

230 mm - 9"	AI 9186-23 SU	AI 9185-23 SU
230 mm - 9"	AI 9186-23 SUB	AI 9185-23 SUB
230 mm - 9"	AI 9170-23 TC	AI 9171-23 TC

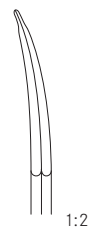
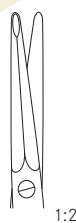

GORNEY-FREEMAN

190 mm - 7½"	AI 9168-19	AI 9167-19
190 mm - 7½"	AI 9168-19 SU	AI 9169-19 SU
190 mm - 7½"	AI 9168-19 SUB	AI 9169-19 SUB
190 mm - 7½"	AI 9170-19 TC	AI 9171-19 TC
190 mm - 7½"	AI 9172-19 SU TC	AI 9173-19 SU TC



Scheren für plastische Operationen
Plastic surgery scissors

Ciseaux pour la chirurgie plastique
Tijeras para cirugía plástica
Forbici per chirurgia plastica



GORNEY-DELICATE

205 mm - 8¼"	AI 9163-20 SU
205 mm - 8¼"	AI 9163-20 SUB
205 mm - 8¼"	AI 9164-20 TC
205 mm - 8¼"	AI 9165-20 SU TC

gebogen
curved
courbe
curva
curve



KAYE

145 mm - 5¾"	AI 9174-14 SU	AI 9175-14 SU
185 mm - 7"	AI 9174-18 SU	AI 9175-18 SU
230 mm - 9"	AI 9176-23 SU	AI 9177-23 SU
145 mm - 5¾"	AI 9174-14 SUB	AI 9175-14 SUB
185 mm - 7"	AI 9174-18 SUB	AI 9175-18 SUB
230 mm - 9"	AI 9176-23 SUB	AI 9177-23 SUB
145 mm - 5¾"	AI 9174-14 TC	AI 9175-14 TC
185 mm - 7"	AI 9174-18 TC	AI 9175-18 TC
230 mm - 9"	AI 9176-23 TC	AI 9177-23 TC
145 mm - 5¾"	AI 9178-14 SU TC	AI 9179-14 SU TC
185 mm - 7"	AI 9178-18 SU TC	AI 9179-18 SU TC
230 mm - 9"	AI 9178-23 SU TC	AI 9179-23 SU TC





Scheren für plastische Operationen
Plastic surgery scissors

Ciseaux pour la chirurgie plastique
Tijeras para cirugía plástica
Forbici per chirurgia plastica

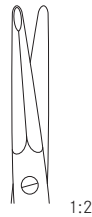

FREEMAN-KAYE

185 mm - 7"	AI 9182-18 SU	AI 9183-18 SU
185 mm - 7"	AI 9182-18 SUB	AI 9183-18 SUB
185 mm - 7"	AI 9172-18 TC	AI 9173-18 TC
185 mm - 7"		AI 9183-18 SU TC

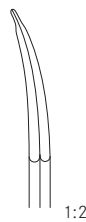

AUFRICHT

150 mm - 5¾"	AI 8706-15 SU	AI 8707-15 SU
150 mm - 5¾"	AI 8706-15 SUB	AI 8707-15 SUB



Scheren für plastische Operationen
Plastic surgery scissors

Ciseaux pour la chirurgie plastique
Tijeras para cirugía plástica
Forbici per chirurgia plastica



KAHN

145 mm - 5½"	AI 8154-14	AI 8155-14
180 mm - 7"	AI 8154-18	AI 8155-18

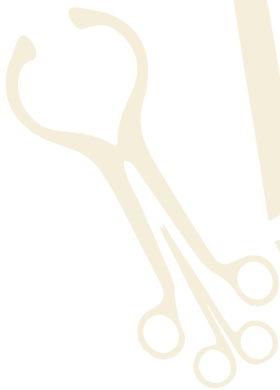

1:2



1:2

GOLDMAN-FOX

130 mm - 5"	AI 9922-13	AI 9923-13
130 mm - 5"	AI 9922-13 SU	AI 9923-13 SU
130 mm - 5"	AI 9922-13 SUB	AI 9923-13 SUB
130 mm - 5"	AI 9924-13 SU TC	AI 9925-13 SU TC

1:2



Face-Lift-Scheren
Face-lift scissors

Ciseaux pour le face-lift
Tijeras para el face-lift
Forbici per "face-lifting"



REES

170 mm - 6 ³ / ₄ "	AI 9182-17	AI 9183-17
205 mm -	AI 9182-20	AI 9183-20
170 mm - 6 ³ / ₄ "	AI 9182-17 SU	AI 9183-17 SU
205 mm -	AI 9182-20 SU	AI 9183-20 SU
170 mm - 6 ³ / ₄ "	AI 9182-17 SUB	AI 9183-17 SUB
205 mm -	AI 9182-20 SUB	AI 9183-20 SUB
170 mm - 6 ³ / ₄ "	AI 9192-17 TC	AI 9193-17 TC
205 mm -	AI 9192-20 TC	AI 9193-20 TC



REES BULLDOG

130 mm - 5"

AI 9199-13

leicht gebogen
slightly curved

légèrement courbe
ligeramente curva
legermente curve

1:2



DAVIS

170 mm - 6³/₄" **AI 9191-18**

170 mm - 6³/₄" **AI 9191-18 SU**

170 mm - 6³/₄" **AI 9191-18 SUB**

1:2



Face-Lift-Scheren
Face-lift scissors

Ciseaux pour le face-lift
Tijeras para el face-lift
Forbici per "face-lifting"



1:2



1:1



1:1

CASTANARES

160 mm - 6 1/4"	AI 9208-16	AI 9209-16
160 mm - 6 1/4"	AI 9210-16 TC	



1:2

GREGORY

145 mm - 5 1/2"	AI 9196-14 TC
-----------------	----------------------

leicht gebogen
slightly curved
légèrement courbe
ligeramente curva
legermente curve



Nasenscheren | Ciseaux nasaux
Nasal scissors | Tijeras nasales
Forbici nasali



KNIGHT
180 mm - 7" | **AI 9205-18**

gewinkelt
angled
angulée
angulado
angulato

1:2



FOMON
135 mm - 5¼" | **AI 8392-14**
135 mm - 5¼" | **AI 8392-14 SU**
135 mm - 5¼" | **AI 8392-14 SUB**

stark gebogen
strongly curved
fortement courbe
fuertemente curva
fortamente curve

1:2

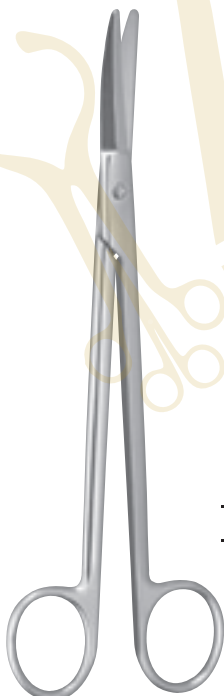

BOETTCHER
180 mm - 7" | **AI 8832-18**

1:2



THOREK
190 mm - 7½" | **AI 8394-19**

1:2



Augenscheren
Blepharoplasty scissors

Ciseaux pour blépharoplastie
Tijeras para blefaroplastica
Forbici per blefaroplastica



1:2



1:1



1:1

S H E A

120 mm - 4 3/4"	AI 9208-12	AI 9209-12
120 mm - 4 3/4"	AI 9208-12 SU	AI 9209-12 SU
120 mm - 4 3/4"	AI 9208-12 SUB	AI 9209-12 SUB

spitz
pointed
pointue
aguda
acuta



1:2



1:1



1:1

B O N N

80 mm - 3 1/4"	AI 9211-09	AI 9212-09
----------------	-------------------	-------------------





Augenscheren
Blepharoplasty scissors

Ciseaux pour blépharoplastie
Tijeras para blefaroplastica
Forbici per blefaroplastica

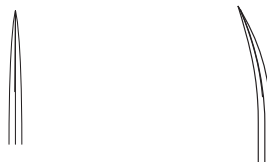

PAR-TYPE

115 mm - 4½"	AI 8188-11	AI 8189-11
145 mm - 5¾"	AI 8188-14	AI 8189-14
115 mm - 4½"	AI 8188-11 SU	AI 8189-11 SU
145 mm - 5¾"	AI 8188-14 SU	AI 8189-14 SU
115 mm - 4½"	AI 8188-11 SUB	AI 8189-11 SUB
145 mm - 5¾"	AI 8188-14 SUB	AI 8189-14 SUB
115 mm - 4½"	AI 9188-11 TC	AI 9189-11 TC
145 mm - 5¾"	tk9188-14 TC	AI 9189-14 TC
115 mm - 4½"	AI 9188-11 SU TC	AI 9189-11 SU TC
145 mm - 5¾"	AI 9188-14 SU TC	AI 9189-14 SU TC

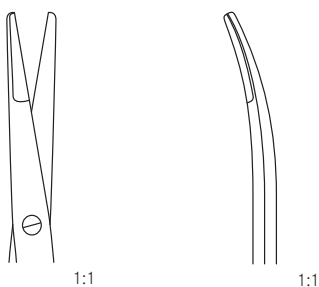

GREENBERG PAR

115 mm - 4½"	AI 9198-11	AI 9199-11
115 mm - 4½"	AI 9198-11 SU	AI 9199-11 SU
115 mm - 4½"	AI 9198-11 SUB	AI 9199-11 SUB
115 mm - 4½"	AI 9200-11 TC	AI 9201-11 TC
115 mm - 4½"	AI 9200-11 SU TC	AI 9201-11 SU TC



1:2



Augenscheren
Blepharoplasty scissors

Ciseaux pour blépharoplastie
Tijeras para blefaroplastica
Forbici per blefaroplastica



1:2



1:1



1:1

KAYE BLEPHAROPLASTY

115 mm - 4½"	AI 8134-11	AI 8135-11
115 mm - 4½"	AI 8134-11 SU	AI 8135-11 SU
115 mm - 4½"	AI 8134-11 SUB	AI 8135-11 SUB
115 mm - 4½"	AI 9134-11 TC	AI 9135-11 TC
115 mm - 4½"	AI 9134-11 SU TC	AI 9135-11 SU TC



1:2



1:1



1:1

KAYE RIBBON TYPE

115 mm - 4½"	AI 9179-11	AI 9180-11
--------------	-------------------	-------------------



Mikro-Federscheren
Micro-scissors

Micro ciseaux à ressorts
Micro tijeras con resorte
Forbici per microchirurgia

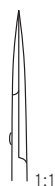
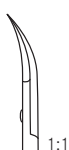
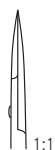
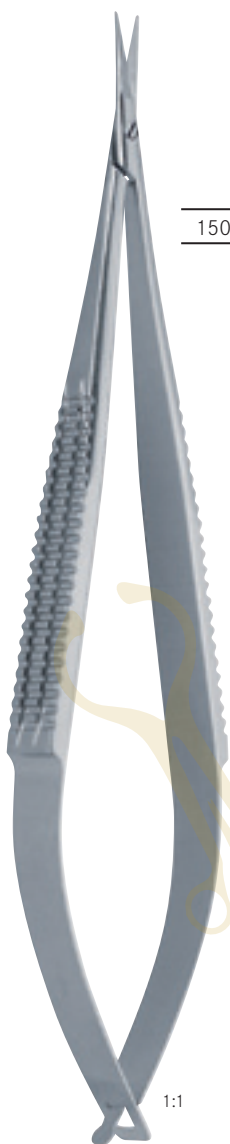

150 mm - 6"	AI 25670-15	AI 25671-15	AI 25672-15	AI 25673-15
	gerade, kurze Schneide straight, short blades droite, lames courtes <i>recta, hojas cortas</i> retta, lama corta	gebogen, kurze Schneide curved short blades courbe, lames courtes <i>curva, hojas cortas</i> curva, lama corta	gerade, lange Schneide straight, long blades droite, lames longues <i>recta, hojas largas</i> retta, lama lunga	gebogen, lange Schneide curved, long blades courbe, lames longues <i>curva, hojas largas</i> curva, lama lunga



150 mm - 6"	AI 25678-15	AI 25679-15
	gerade, gezahnt straight, saw edge droite, dentelée <i>recta, dentadas</i> retta, dentata	gebogen, gezahnt scurved, aw edge courbe, dentelée <i>curva, dentadas</i> curva, dentata

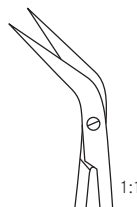

150 mm - 6"	AI 25675-15
180 mm - 7"	AI 25677-18

kniegebogen, 45°
angled on flat, 45°
angulaire, 45°
acodada, 45°
angolata, 45°



Mikro-Präparierscheren
Micro dissecting scissors

Micro ciseaux à dissection
Micro tijeras de disección
Forbici per micro chirurgia con manico rotondo

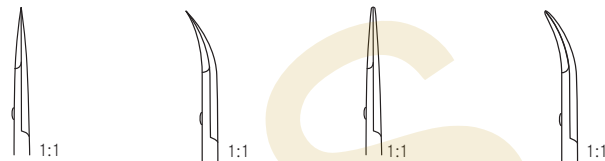
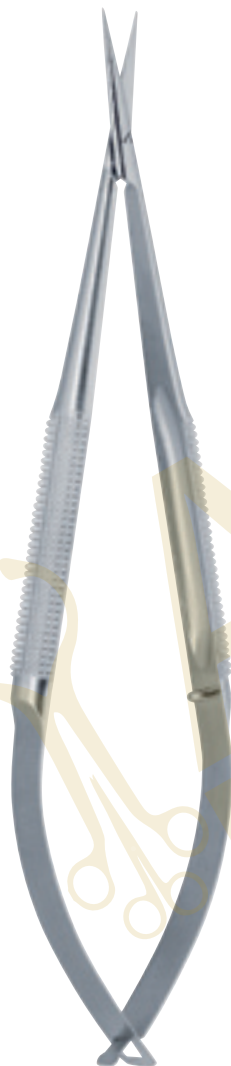

145 mm - 5 3/4 "	AI 25602-01	AI 25603-01	AI 25602-02	AI 25603-02
180 mm - 7 "	AI 25610-01	AI 25611-01	AI 25610-02	AI 25611-02

kurze Schneide 8 mm, glatt
short blades 8 mm, smooth
lames courtes 8 mm, lisses
hojas cortas 8 mm, lisos
lama corta 8 mm, liscia

gerade,
straight

gebogen,
curved

gerade,
straight

gebogen,
curved

gerade, pointues
rectas, agudas
retta, acuta

gebogen, pointues
curvas, agudas
curva, acuta

gerade, mousses
rectas, romas
retta, smussa

gebogen, mousses
curvas, romas
curva, smussa

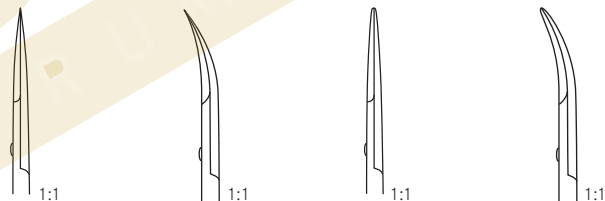

145 mm - 5 3/4 "	AI 25602-03	AI 25603-03	AI 25602-04	AI 25603-04
180 mm - 7 "	AI 25610-03	AI 25611-03	AI 25610-04	AI 25611-04

lange Schneide 14 mm, glatt
long blades 14 mm, smooth
lames longues 14 mm, lisses
hojas largas 14 mm, lisos
lama lunga 14 mm, liscia

gerade,
straight

gebogen,
curved

gerade,
straight

gebogen,
curved

gerade, pointues
rectas, agudas
retta, acuta

gebogen, pointues
curvas, agudas
curva, acuta

gerade, mousses
rectas, romas
retta, smussa





gebogen, mousses
curvas, romas
curva, smussa



Mikroscheren mit Rundgriff
Micro scissors with round handle

Micro ciseaux avec manche ronde
Micro tijeras con mango redondo
Forbici per micro chirurgia con manico rotondo



VANNAS		VANNAS	
	 1:1	 1:1	
	7 mm Ø	7 mm Ø	
120 mm - 5"	AI 25612-12	AI 25613-12	
CASTROVIEJO		CASTROVIEJO	
	 1:1	 1:1	
	8 mm Ø	8 mm Ø	
150 mm - 6"	AI 25610-15	AI 25611-15	



Mikroscheren mit Rundgriff
Micro scissors with round handle

Micro ciseaux avec manche ronde
Micro tijeras con mango redondo
Forbici per micro chirurgia con manico rotondo

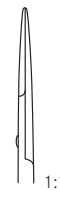
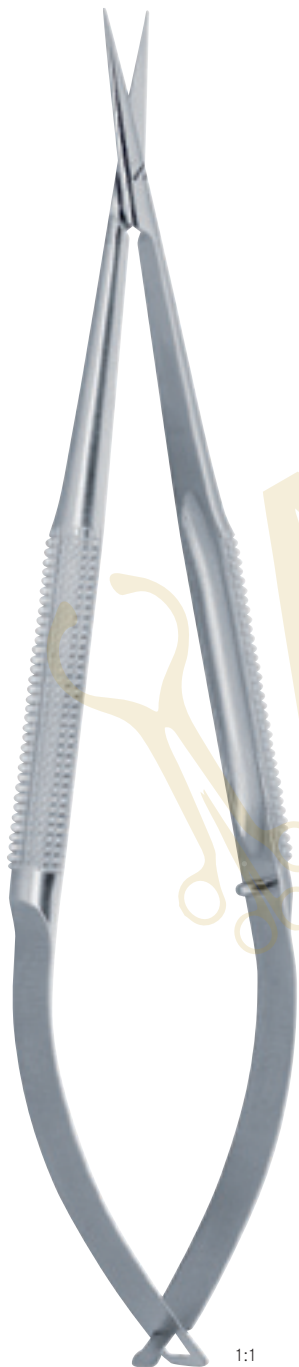

	180 mm - 7"	180 mm - 7"	180 mm - 7"	180 mm - 7"	180 mm - 7"	180 mm - 7"
8 mm Ø	AI 25606-18	AI 25607-18				
10 mm Ø	AI 25602-18	AI 25603-18	AI 25618-18	AI 25619-18	AI 25620-18	AI 25621-18

1:1



Anatomische Pinzetten - Chirurgische Pinzetten
Dressing forceps - Dissecting forceps

Pinces à dissection - Pincas à dissection à griffes
Pinzas de disección - Pinzas de disección con dientes
Pinze per dissezione - Pinze per dissezione con denti

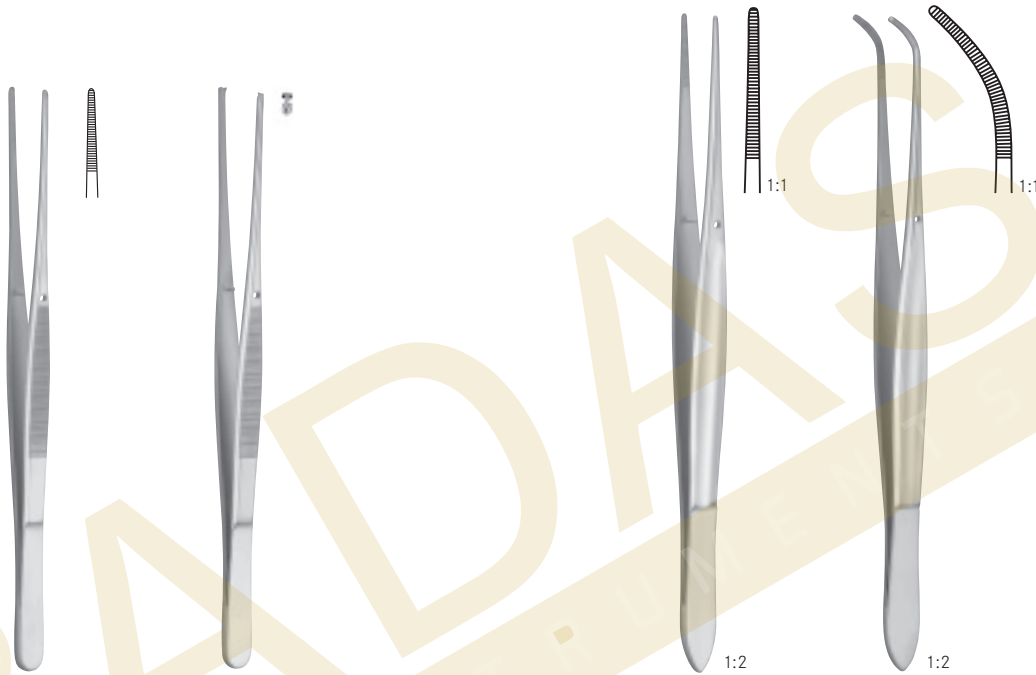

SEMKEN

125 mm - 5"	AI 10300-12	AI 11300-12
150 mm - 6"	AI 10300-15	AI 11300-15

CUSHING

175 mm - 7"	AI 10400-17	AI 10401-17
175 mm - 7"	AI 10402-17 TC	



Anatomische Pinzetten - Chirurgische Pinzetten
Dressing forceps - Dissecting forceps

Pincès à dissection - Pincès à dissection à griffes
Pinzas de disección - Pinzas de disección con dientes
Pinze per dissezione - Pinze per dissezione con denti



GILLIES
150 mm - 6"
AI 11250-15





MC INDOE
150 mm - 6" **AI 10550-15**
150 mm - 6" **AI 11640-15 TC**



WANGENSTEEN
150 mm - 6" **AI 10608-15**
230 mm - 9" **AI 10608-23**

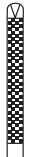
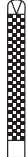
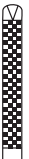

OEHLER			
			
140 mm - 5½"	160 mm - 6¼"	180 mm - 7"	
AI 11690-14 TC	AI 11690-16 TC	AI 11690-18 TC	
			
200 mm - 8"	250 mm - 9¾"	300 mm - 12"	
AI 11690-20 TC	AI 11690-25 TC	AI 11690-30 TC	



Anatomische Pinzetten - Chirurgische Pinzetten
Dressing forceps - Dissecting forceps

Pinces à dissection - Pinces à dissection à griffes
Pinzas de disección - Pinzas de disección con dientes
Pinze per dissezione - Pinze per dissezione con denti

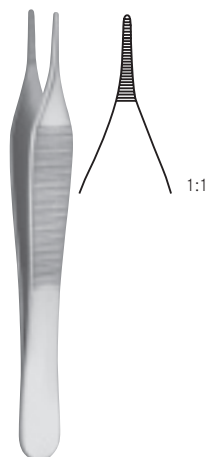

ADSON

120 mm - 4¾"	AI 10500-12
150 mm - 6"	AI 10500-15
120 mm - 4¾"	AI 10502-12 TC
150 mm - 6"	AI 10502-15 TC



MICRO-ADSON

120 mm - 4¾"	AI 10503-12
150 mm - 6"	AI 10503-15



ADSON-GRAEFE

120 mm - 4¾"	AI 11212-12
--------------	--------------------



ADSON BROWN

120 mm - 4¾"	AI 11210-12
120 mm - 4¾"	AI 10508-12 TC



Anatomische Pinzetten - Chirurgische Pinzetten
Dressing forceps - Dissecting forceps

Pinces à dissection - Pinces à dissection à griffes
Pinzas de disección - Pinzas de disección con dientes
Pinze per dissezione - Pinze per dissezione con denti



ADSON

120 mm - 4 3/4"	AI 11200-12	AI 11204-12
150 mm - 6"	AI 11200-15	
120 mm - 4 3/4"	AI 10504-12 TC	
150 mm - 6"	AI 10504-15 TC	



MICRO-ADSON

AI 11202-12	AI 11206-12
AI 11202-15	AI 11206-15
AI 10506-12 TC	
AI 10506-15 TC	



ADSON

120 mm - 4 3/4"
AI 11206-13

mit Fadenplatte 1 mm
with tying platform 1 mm
avec plateforme pour sutures 1 mm
con plataforma para suturas 1 mm
con plattafoma per suture 1 mm



ULTRA-MICRO-ADSON
(BRAKA)

120 mm - 4 3/4"
AI 11206-12B

mit Fadenplatte 1 mm
with tying platform 1 mm
avec plateforme pour sutures 1 mm
con plataforma para suturas 1 mm
con plattafoma per suture 1 mm



Anatomische Pinzetten - Chirurgische Pinzetten
Dressing forceps - Dissecting forceps

Pinces à dissection - Pinces à dissection à griffes
Pinzas de disección - Pinzas de disección con dientes
Pinze per dissezione - Pinze per dissezione con denti



GRAEFE

105 mm - 4 1/4"

AI 11700-10

AI 11701-10

AI 11703-10

AI 11730-10

AI 11731-10

AI 11733-10



Anatomische Pinzetten - Chirurgische Pinzetten
Dressing forceps - Dissecting forceps

Pinces à dissection - Pinces à dissection à griffes
Pinzas de disección - Pinzas de disección con dientes
Pinze per dissezione - Pinze per dissezione con denti



ADLERKREUTZ

150 mm - 6"	AI 11086-15	AI 11087-15
200 mm - 8"	AI 11086-20	AI 11087-20
250 mm - 9¾"		AI 11087-25

WAUGH

150 mm - 6"	AI 10616-15
200 mm - 8"	AI 10616-20
250 mm - 9¾"	AI 10616-25



1:2
DUEHRSSEN
200 mm - 8"
AI 10604-20



105 mm - 4¼"
AI 11635-10

Columella Pinzette
Columella forceps
Pince à columella
Pinza para columella
Pinze per columella



Anatomische Pinzetten - Chirurgische Pinzetten
Dressing forceps - Dissecting forceps

Pincès à dissection - Pincès à dissection à griffes
Pinzas de disección - Pinzas de disección con dientes
Pinze per dissezione - Pinze per dissezione con denti

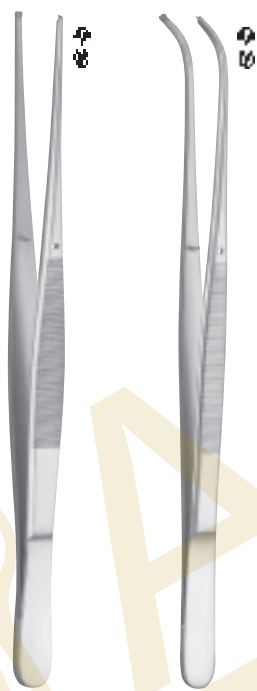

POTTS-SMITH

180 mm - 7"	AI 11150-18	AI 11151-18
210 mm - 8¼"	AI 11150-21	AI 11151-21
250 mm - 9¾"	AI 11150-25	AI 11151-25



BROPHY

200 mm - 8"	AI 11100-20	AI 11101-20
-------------	--------------------	--------------------



Anatomische Pinzetten - Chirurgische Pinzetten
Dressing forceps - Dissecting forceps

Pinces à dissection - Pinces à dissection à griffes
Pinzas de disección - Pinzas de disección con dientes
Pinze per dissezione - Pinze per dissezione con denti

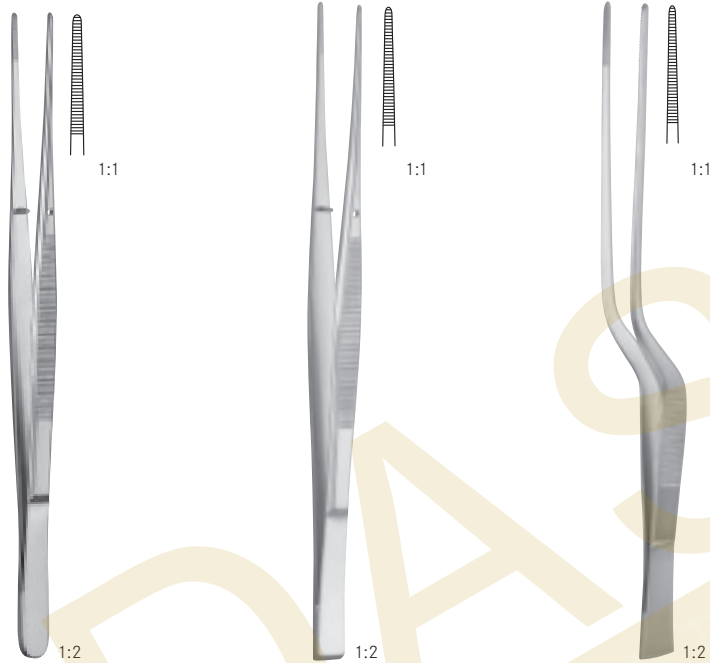

TAYLOR

175 mm - 7"	AI 10310-17	AI 10312-17	AI 10313-17
-------------	--------------------	--------------------	--------------------

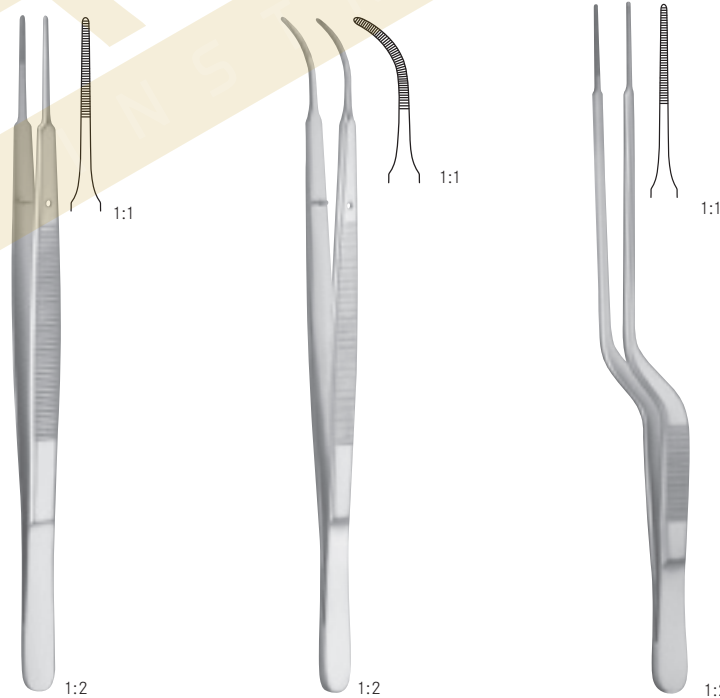

GERALD

180 mm - 7"	AI 10324-18	AI 10325-18	AI 10326-19
-------------	--------------------	--------------------	--------------------



Atraumatische Pinzetten
Atraumatic tissue forceps

Pinces atraumatiques
Pinzas de disección atraumáticas
Pinze per dissezione atraumatiche

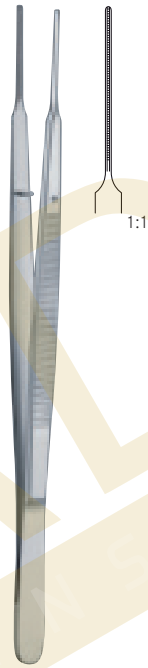

DE BAKLEY-GERALD

150 mm - 6"	AI 10327-15
180 mm - 7"	AI 10327-18



DE BAKLEY BAYONET

180 mm - 7"	AI 10328-18
200 mm - 8"	AI 10328-20



Atraumatische Pinzetten
Atraumatic tissue forceps

Pinces atraumatiques
Pinzas de disección atraumáticas
Pinze per dissezione atraumatiche



DE BAKAY	x = 1.5 mm	x = 2.0 mm
120 mm - 4 ³ / ₄ "	AI 11960-12	
145 mm - 5 ³ / ₄ "	AI 11960-14	AI 11964-14
160 mm - 6 ¹ / ₄ "	AI 11960-16	AI 11964-16
200 mm - 8 "	AI 11960-20	AI 11964-20
240 mm - 9 ¹ / ₂ "	AI 11960-24	AI 11964-24
300 mm - 12 "		AI 11964-30



Atraumatische Pinzetten
Atraumatic tissue forceps

Pinces atraumatiques
Pinzas de disección atraumáticas
Pinze per dissezione atraumatiche

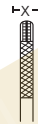

DE BAKEY

	x = 1.5 mm	x = 2.0 mm
150 mm - 6"	AI 11968-15 TC	AI 11969-15 TC
190 mm - 7½"	AI 11968-19 TC	AI 11969-19 TC
240 mm - 9½"	AI 11968-24 TC	AI 11969-24 TC





Mikro-Pinzetten | Pinces micro
Micro forceps | *Micro pinzas*
Micro pinze



	x = 0.3 mm	x = 0.5 mm
150 mm - 6"	AI 25686-30	
180 mm - 7"		AI 25686-35

mit Fadenplatte
with tying platform

avec plateforme pour sutures
con plataforma para suturas
con plattaforma per suture



	x = 0.3 mm	x = 0.5 mm
150 mm - 6"	AI 25687-30	
180 mm - 7"		AI 25687-335

mit Fadenplatte
with tying platform

avec plateforme pour sutures
con plataforma para suturas
con plattaforma per suture



Mikro-Pinzetten | Pincés micro
Micro forceps | *Micro pinzas*
Micro pinze

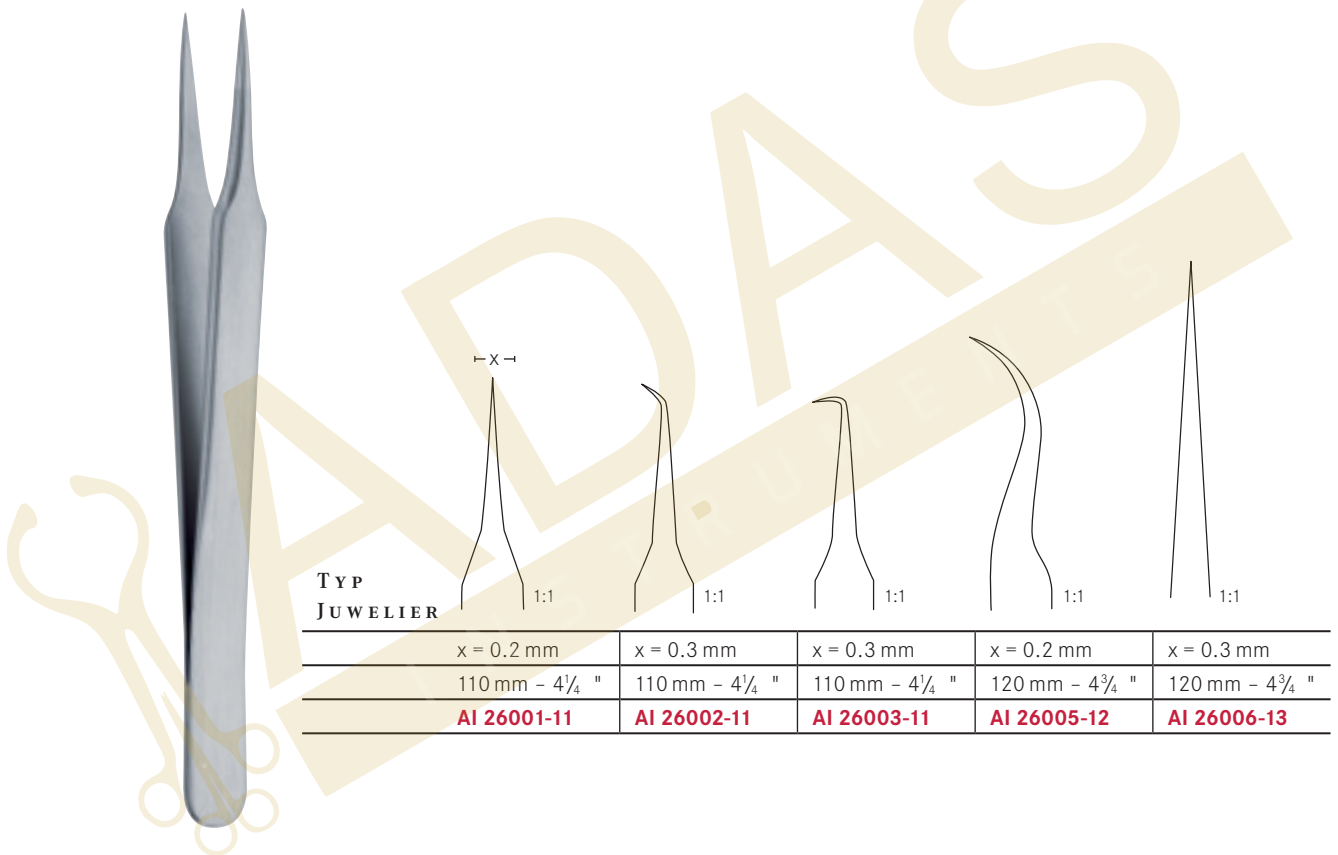

TYP
JUWELIER

x = 0.2 mm	x = 0.3 mm	x = 0.3 mm	x = 0.2 mm	x = 0.3 mm
110 mm - 4 ¹ / ₄ "	110 mm - 4 ¹ / ₄ "	110 mm - 4 ¹ / ₄ "	120 mm - 4 ³ / ₄ "	120 mm - 4 ³ / ₄ "
AI 26001-11	AI 26002-11	AI 26003-11	AI 26005-12	AI 26006-13



Mikro-Pinzetten
Micro forceps

Pinces micro
Micro pinzas
Micro pinze

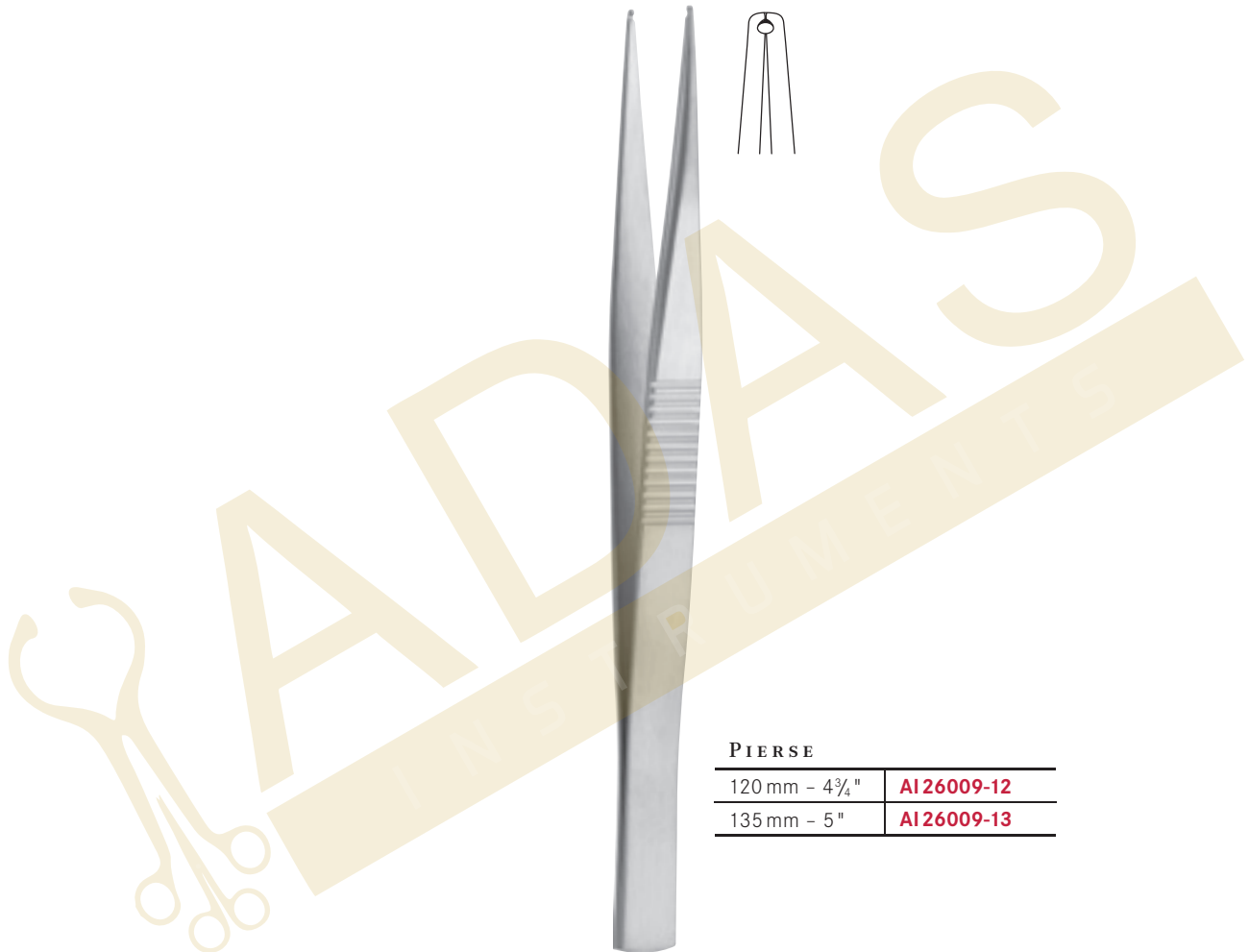

PIERSE

120 mm - 4 $\frac{3}{4}$ "	AI 26009-12
135 mm - 5"	AI 26009-13



Gefäßdilatoren
Vessel dilators

Dilatateurs vasculaires
Dilatadores vasculares
Dilatatori vascolari

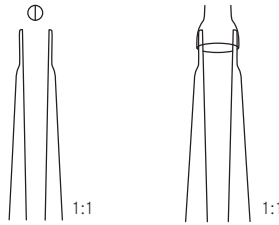

	x = 0.2 mm	x = 0.3 mm
110 mm - 4 1/4 "	AI 26015-02	AI 26015-03

sehr fein
very fine
très fin
muy fino
molto fino

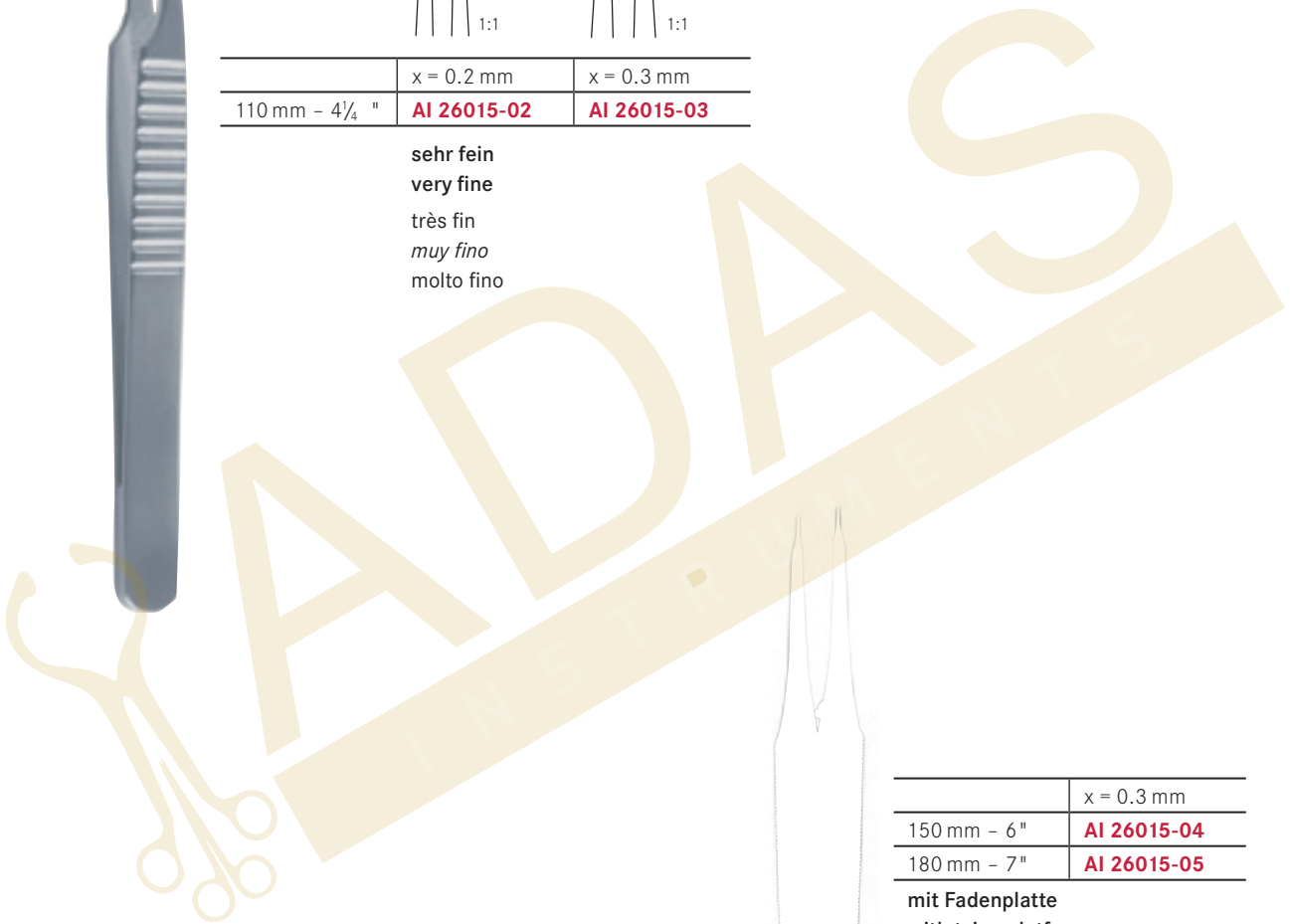

	x = 0.3 mm
150 mm - 6 "	AI 26015-04
180 mm - 7 "	AI 26015-05

mit Fadenplatte
with tying platform

avec plateforme pour sutures
con plataforma para suturas
con piattaforma per suture



Approximatoren, Gefäßclips nach Biemer
Approximators, Biemer clips

Approximateurs, clips selon Biemer
Approximadores, Biemer clips
Approssimatori, clips vascolari Biemer



1:3

BIEMER

	AI 25209-02	AI 25209-01
	Anlegepinzette mit Schloss applying forceps with lock	Anlegepinzette ohne Schloss applying forceps without lock
	pince à poser avec verrou aplicadora con cierre pinza posa clips con cremagliera	pince à poser sans verrou aplicadora sin cierre pinza posa clips senza cremagliera



	x	y	gms
	Maullänge jaw length longueur du mors longitud de la boca lunghezza del morso	max. Maulöffnung max. jaw opening ouverture max. du mors apertura max. de la boca apertura mass.	Schließkraft closing pressure force de fermeture fuerza de cierre pressione



AI 25210-00

x = 6 mm
y = 4 mm
30 gms - 40 gms



AI 25211-00

x = 9 mm
y = 5 mm
30 gms - 40 gms



AI 25212-00

x = 9 mm
y = 5 mm
20 gms - 25 gms

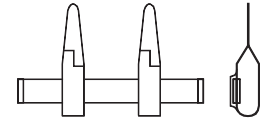

AI 25213-00

x = 4,5 mm
y = 3,0 mm
30 gms - 40 gms

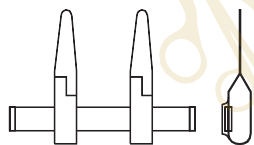

AI 25214-00

x = 9 mm
y = 5 mm
30 gms - 40 gms

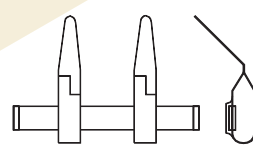

AI 25215-00

x = 9 mm
y = 5 mm
30 gms - 40 gms

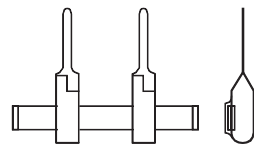

AI 25216-00

x = 9 mm
y = 5 mm
20 gms - 25 gms

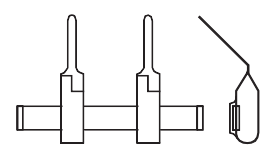

AI 25217-00

x = 9 mm
y = 5 mm
30 gms - 40 gms

Für temporären Gebrauch, (gekennzeichnet durch gelb eingefärbte Federenden) für Gefäße mit 0,5 mm - 2,0 mm Ø. Maulinnenflächen schräg gerieft für schonendes und sicheres Festhalten der Gefäße. Der fest eingestellte Schliessdruck gewährt risikofreie Anwendung

For temporary occlusion, (identified by yellow coloured spring ends) for vessels of 0,5 mm - 2,0 mm Ø. Blade gripping surface with oblique serrations for save but careful gripping of vessels. No risk due to rigidly fixed pressure measure

Pour usage temporaire, (ressorts couleur jaune) pour vaisseau de 0,5 mm - 2,0 mm Ø. Mors striés pour fixation sûr et menagement. Force du fermeture non changeable

Para oclusión temporal (ressortes amarillos) para vasos de 0,5 mm - 2,0 mm Ø. Boca estriada para fijación segura y moderada de los vasos. Utilización sin riesgo con fuerza de oclusión fija

Per uso temporaneo, con finale della molla giallo, per vasi di 0,5 mm - 2,0 mm Ø. Morso zignanto per una presa sicura, non traumatica



Anlegepinzetten für Gefäßclips
 Applying forceps for vessel clips

 Pincès à poser des clips
Aplicadoras para clips
 Pinze per mettere clips

140 mm - 5½"	AI 25059-01	AI 25059-02
--------------	--------------------	--------------------

ohne Schloß without lock sans serrure <i>sin cierre</i> senza cremagliera	mit Schloß with lock avec serrure <i>con cierre</i> con cremagliera
---	---



140 mm - 5½"	AI 25059-03
--------------	--------------------

 für Approximatoren und Doppelklemmen
 for approximators and double-clips
 pour approximateurs et clips doubles
para aproximadores y clips dobles
 per approssimatori e clips doppi

x	Ø	V	A
Länge	Gefäß	Vene	Arterie
Length	Vessel	Vein	Artery
Longueur	Vaisseau	Veine	Artère
<i>Longitud</i>	<i>Vaso</i>	<i>Vena</i>	<i>Arteria</i>
Lunghezza	Vaso	Vena	Arteria

 Weitere Modelle und Ausführungen auf Anfrage
 Other models and executions upon request

Autres modèles et exécutions sur demande
Otros modelos y ejecuciones segun demanda
 Altri modelli a richiesta

50 x 25 x 4.5 mm	75 x 25 x 4.5 mm	70 x 45 x 8 mm
AI 55210-01	AI 55210-02	AI 55210-03

 Lagerungstrays für Gefäßclips
 Trays for storage of vessel clips

Boîtes pour clips vasculaires
Cajas para clips vasculares
 Scatole per clips vascolari



Approximateuren, Gefäßclips
Approximators, clips

Approximateurs, clips
Approximadores, clips
Approssimatori, clips vascolari

x = 8 mm				
V	AI 25060-01	AI 25060-02	AI 25060-03	AI 25060-04
A	AI 25070-01	AI 25070-02	AI 25070-03	AI 25070-04
Ø = 0,4 mm - 1 mm				
x = 11 mm				
V	AI 25061-01	AI 25061-02	AI 25061-03	AI 25061-04
A	AI 25071-01	AI 25071-02	AI 25071-03	AI 25071-04
Ø = 0,6 mm - 1,5 mm				
x = 14 mm				
V	AI 25062-01	AI 25062-02	AI 25062-03	AI 25062-04
A	AI 25072-01	AI 25072-02	AI 25072-03	AI 25072-04
Ø = 1 mm - 2 mm				
x = 17 mm				
V	AI 25063-01	AI 25063-02	AI 25063-03	AI 25063-04
A	AI 25073-01	AI 25073-02	AI 25073-03	AI 25073-04
Ø = 1 mm - 2,25 mm				
x = 25 mm				
V	AI 25064-01	AI 25064-02	AI 25064-03	AI 25064-04
A	AI 25074-01	AI 25074-02	AI 25074-03	AI 25074-04
Ø = 1,5 mm - 3,5 mm				
x = 36 mm				
V	AI 25065-01	AI 25065-02	AI 25065-03	AI 25065-04
A	AI 25075-01	AI 25075-02	AI 25075-03	AI 25075-04
Ø = 1,5 mm - 3,5 mm				

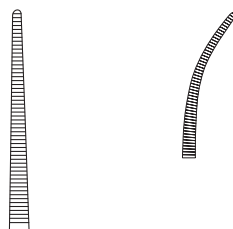

**Arterienklemmen
Haemostatic forceps**
**Pinces hémostatiques
Pinzas hemostáticas
Pinze emostatiche**

P É A N

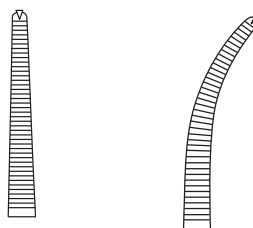
130 mm - 5"	AI 12058-13-P	AI 12059-13-P
140 mm - 5 1/2"	AI 12058-14-P	AI 12059-14-P
160 mm - 6 1/4"	AI 12058-16-P	AI 12059-16-P

**graziles Modell
delicate pattern
modèle délicat
modelo delicado
modello delicato**

K O C H E R

130 mm - 5"	AI 12078-13-P	AI 12079-13-P
140 mm - 5 1/2"	AI 12078-14-P	AI 12079-14-P
160 mm - 6 1/4"	AI 12078-16-P	AI 12079-16-P

**graziles Modell
delicate pattern
modèle délicat
modelo delicado
modello delicato**

1x2

1x2



Arterienklemmen | Pincés hémostatiques
Haemostatic forceps | *Pinzas hemostáticas*
Pinze emostatiche



1:2

HARTMANN



1:1

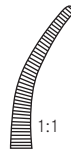

1:1

100 mm - 4"	AI 12000-10-P	AI 12001-10-P
-------------	---------------	---------------



MICRO-
MOSQUITO



100 mm - 4"	AI 12020-10-P	AI 12021-10-P	AI 12022-10-P	AI 12023-10-P
120 mm - 4 3/4"	AI 12020-12-P	AI 12021-12-P	AI 12022-12-P	AI 12023-12-P

1x2

1x2



HALSTED-
MOSQUITO

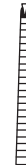

125 mm - 5"	AI 12010-12-P	AI 12011-12-P	AI 12012-12-P	AI 12013-12-P
140 mm - 5 1/2"	AI 12010-14-P	AI 12011-14-P	AI 12012-14-P	AI 12013-14-P

1x2

1x2



Arterienklemmen
Haemostatic forceps

Pinces hémostatiques
Pinzas hemostáticas
Pinze emostatiche



KELLY

140 mm - 5½"	AI 12040-14-P	AI 12041-14-P
--------------	----------------------	----------------------

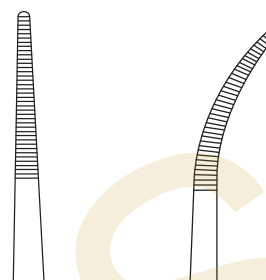

KELLY-RANKIN

160 mm - 6¼"	AI 12040-16-P	AI 12041-16-P
--------------	----------------------	----------------------



CRILE

140 mm - 5½"	AI 12050-14-P	AI 12051-14-P
--------------	----------------------	----------------------

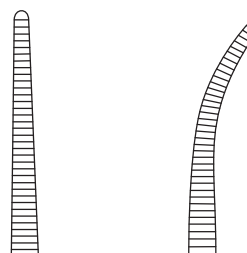

CRILE-RANKIN

160 mm - 6¼"	AI 12050-16-P	AI 12051-16-P
--------------	----------------------	----------------------



Arterienklemmen
Haemostatic forceps

Pincas hémostatiques
Pinzas hemostáticas
Pinze emostatiche

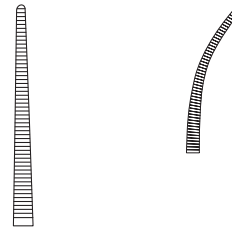

P É A N

130 mm - 5"	AI 12058-13-P	AI 12059-13-P
140 mm - 5 1/2"	AI 12058-14-P	AI 12059-14-P
160 mm - 6 1/4"	AI 12058-16-P	AI 12059-16-P

graziles Modell
delicate pattern
modèle délicat
modelo delicado
modello delicato

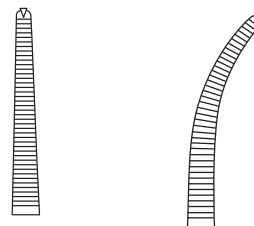

K O C H E R

130 mm - 5"	AI 12078-13-P	AI 12079-13-P
140 mm - 5 1/2"	AI 12078-14-P	AI 12079-14-P
160 mm - 6 1/4"	AI 12078-16-P	AI 12079-16-P

graziles Modell
delicate pattern
modèle délicat
modelo delicado
modello delicato

1x2

1x2



Arterienklemmen
Haemostatic forceps

Pinces hémostatiques
Pinzas hemostáticas
Pinze emostatiche



PÉAN-
FINO

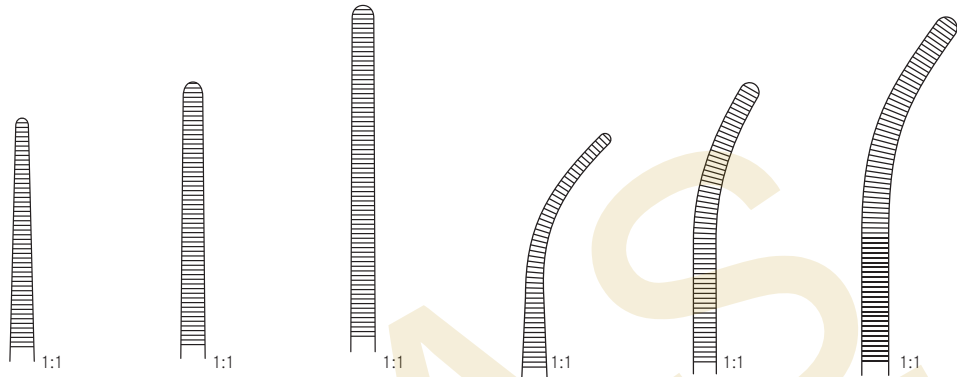

145 mm - 5 3/4 "	165 mm - 6 1/2 "	185 mm - 7 1/4 "	140 mm - 5 1/2 "	160 mm - 6 1/4 "	180 mm - 7 "
AI 12062-14-P	AI 12062-16-P	AI 12062-18-P	AI 12063-14-P	AI 12063-16-P	AI 12063-18-P



KOCHER-
FINO

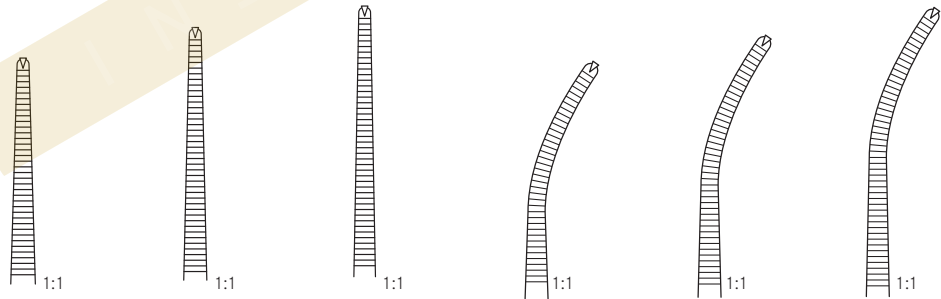

145 mm - 5 3/4 "	165 mm - 6 1/2 "	185 mm - 7 1/4 "	145 mm - 5 3/4 "	160 mm - 6 1/4 "	180 mm - 7 "
AI 12082-14-P	AI 12082-16-P	AI 12082-18-P	AI 12083-14-P	AI 12083-16-P	AI 12083-18-P

1x2 1x2 1x2 1x2 1x2 1x2



Arterienklemmen
Haemostatic forceps

Pinces hémostatiques
Pinzas hemostáticas
Pinze emostatiche



1:2

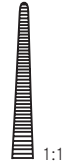

1:1



1:1

HARTMANN

100 mm - 4"	AI 12000-10	AI 12001-10
-------------	--------------------	--------------------



1:2



HALSTED-MOSQUITO

125 mm - 5"	AI 12010-12	AI 12011-12	AI 12012-12	AI 12013-12
140 mm - 5½"	AI 12010-14	AI 12011-14	AI 12012-14	AI 12013-14

1x2

1x2

125 mm - 5"	AI 12110-12	AI 12111-12	AI 12112-12	AI 12113-12
-------------	--------------------	--------------------	--------------------	--------------------

Titan
Titanium
Titane
Titanio
Titanio

1x2

1x2



1:2



MICRO-MOSQUITO

100 mm - 4"	AI 12020-10	AI 12021-10	AI 12022-10	AI 12023-10
120 mm - 4¾"	AI 12020-12	AI 12021-12	AI 12022-12	AI 12023-12



Arterienklemmen | Pincés hémostatiques
Haemostatic forceps | *Pinzas hemostáticas*
Pinze emostatiche



1:2

DANDY

140 mm - 5 1/2"

AI 12030-14

AI 12032-14

seitlich gebogen
curved to the side
courbe sur le plat
curva al lado
curvata lateralmente

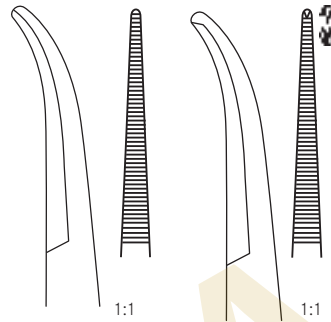

1:1

1:1

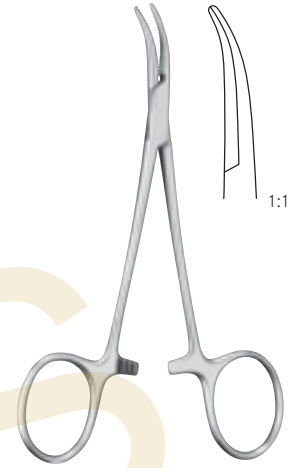

1:2

MOSQUITO-DANDY

AI 12031-12

120 mm - 4 3/4"

seitlich gebogen
curved to the side
courbe sur le plat
curva al lado
curvata lateralmente



1:2

PROVIDENCE-HOSPITAL

140 mm - 5 1/2"

AI 12020-14

AI 12021-14

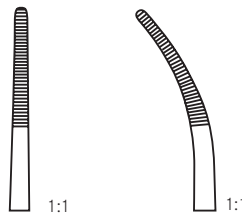

1:1

1:1



Arterienklemmen
Haemostatic forceps

Pinces hémostatiques
Pinzas hemostáticas
Pinze emostatiche

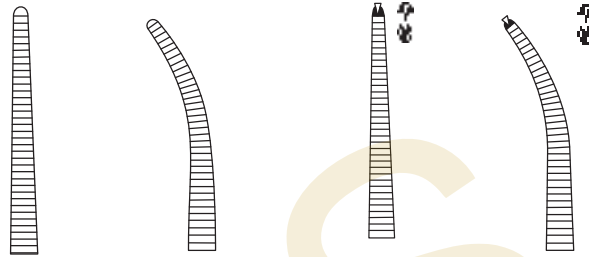

CRILE

140 mm - 5½"	AI 12050-14	AI 12051-14	AI 12052-14	AI 12053-14
--------------	-------------	-------------	-------------	-------------

CRILE-RANKIN

160 mm - 6¼"	AI 12050-16	AI 12051-16	AI 12054-16	AI 12055-16
--------------	-------------	-------------	-------------	-------------

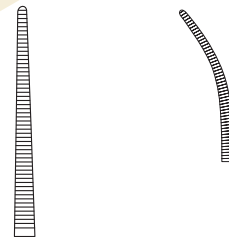

PÉAN

130 mm - 5"	AI 12058-13	AI 12059-13
140 mm - 5½"	AI 12058-14	AI 12059-14
160 mm - 6¼"	AI 12058-16	AI 12059-16

graziles Modell
delicate pattern
modèle délicat
modelo delicado
modello delicato



Arterienklemmen
Haemostatic forceps

Pinces hémostatiques
Pinzas hemostáticas
Pinze emostatiche

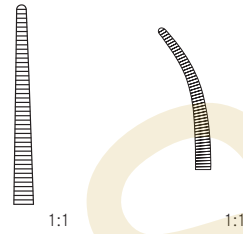

LERICHE

150 mm - 6"	AI 12034-15	AI 12035-15
-------------	--------------------	--------------------

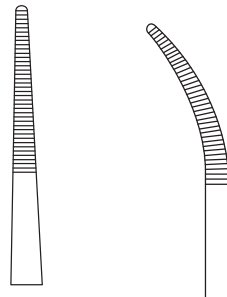

KELLY

140 mm - 5 1/2"	AI 12040-14	AI 12041-14
-----------------	--------------------	--------------------

KELLY-RANKIN

160 mm - 6 1/4"	AI 12040-16	AI 12041-16
-----------------	--------------------	--------------------



Arterienklemmen
Haemostatic forceps

Pinces hémostatiques
Pinzas hemostáticas
Pinze emostatiche

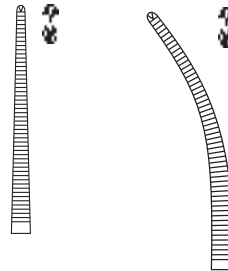

KOCHER

130 mm - 5"	AI 12078-13	AI 12079-13
140 mm - 5½"	AI 12078-14	AI 12079-14
160 mm - 6¼"	AI 12078-16	AI 12079-16

graziles Modell
delicate pattern
modèle délicat
modelo delicado
modello delicato

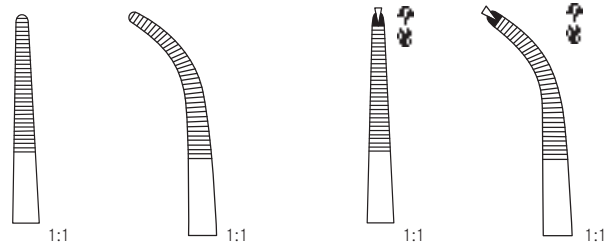

ADSON

185 mm - 7¼"	AI 12210-18	AI 12211-18	AI 12212-18	AI 12213-18
--------------	--------------------	--------------------	--------------------	--------------------

1:2



Arterienklemmen | Pincés hémostatiques
Haemostatic forceps | *Pinzas hemostáticas*
Pinze emostatiche

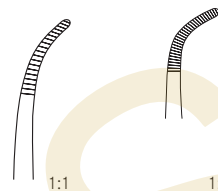
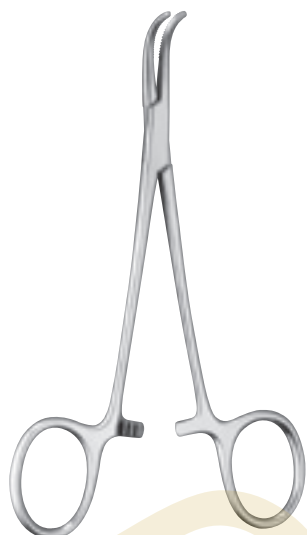

BABY-MIXTER

140 mm - 5½"	AI 12220-14	
180 mm - 7"		AI 12220-18

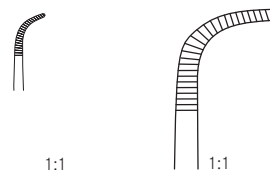

BABY-ADSON

140 mm - 5½"	AI 12221-14	
180 mm - 7"		AI 12221-18



Gewebe- und Darmfazzangen | Pincas intestinales et de tissue
Tissue and intestinal holding forceps | *Pinzas para tejidos y intestinos*
Pinze per tessuti ed intestinali



ALLIS-BABY

130 mm - 5"

AI 28100-14

4 x 5



ALLIS

150 mm - 6"

AI 28140-15

AI 28160-15

190 mm - 7½"

AI 28160-19

250 mm - 9¾"

AI 28160-25

4 x 5

5 x 6



ALLIS-ADAIR

155 mm - 6'

AI 28167-15

10 x 11

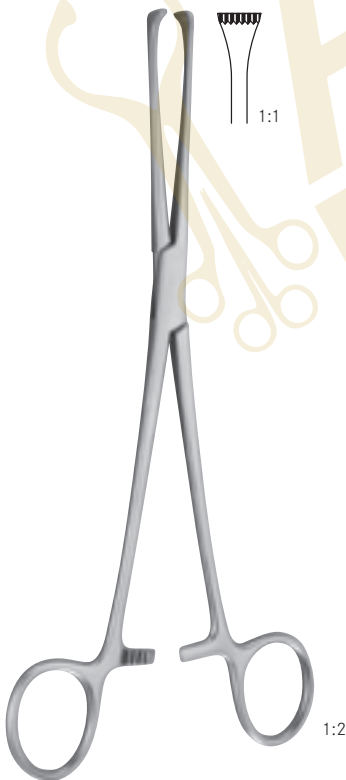

THOMS-ALLIS

200 mm - 8"

AI 28180-20

6 x 7



LOCKWOOD

200 mm - 8"

AI 28190-20



WILLIAMS

160 mm - 6¼"

AI 28192-16



Tupfer- und Schwammzangen
Cotton swab forceps, sponge holding forceps

Pinces à tampons et éponges
Pinzas para tampones y esponjas
Pinze per tamponi

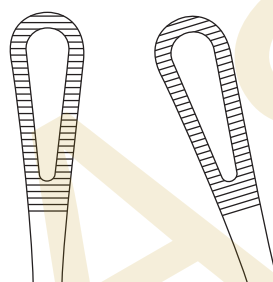

RAMPLEY

180 mm - 7"	AI 15130-18	AI 15131-18
250 mm - 10"	AI 15130-25	AI 15131-25



FOERSTER (BALLENGER)

180 mm - 7"	AI 15180-18	AI 15182-18	AI 15183-18	AI 15185-18
200 mm - 8"		AI 15182-20		AI 15185-20
250 mm - 10"	AI 15180-25	AI 15182-25	AI 15183-25	AI 15185-25



Nasen- und Trachealhäkchen
Trachea and nose retractors

Ecarteurs nasales et trachéales
Separadores para la traquea y la nariz
Uncini tracheali e nasali



1:2

KILNER

150 mm - 6"

AI48128-15



1:2

GILLIES

180 mm - 7"



1:1

Fig. 1

AI48130-01



1:1

Fig. 2

AI48130-02

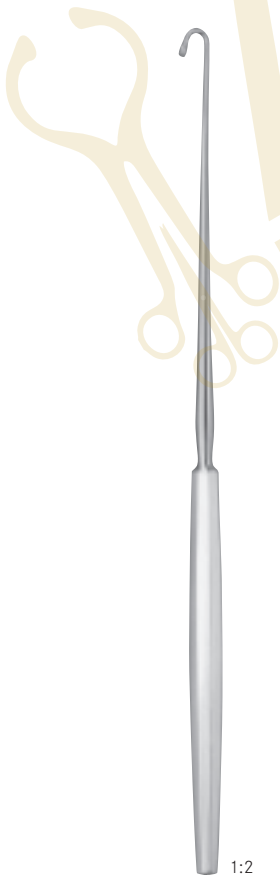

1:2

LANGE

220 mm - 8 $\frac{3}{4}$ "

AI 16901-22



1:2

COTTLE

160 mm - 6 $\frac{1}{4}$ "

AI 16902-16



1:2

FOMON

170 mm - 6 $\frac{3}{4}$ "

AI 16904-17



Nasen- und Trachealhäkchen
Trachea and nose retractors

Ecarteurs nasales et trachéales
Separadores para la traquea y la nariz
Uncini tracheali e nasali

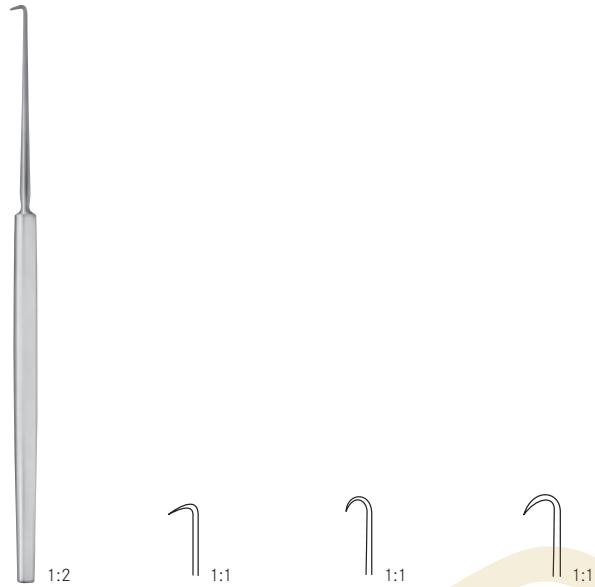

COTTLE

150 mm - 6"	AI 16905-01	AI 16905-02	AI 16905-03
-------------	--------------------	--------------------	--------------------



JOSEPH

150 mm - 6"
AI 16900-15

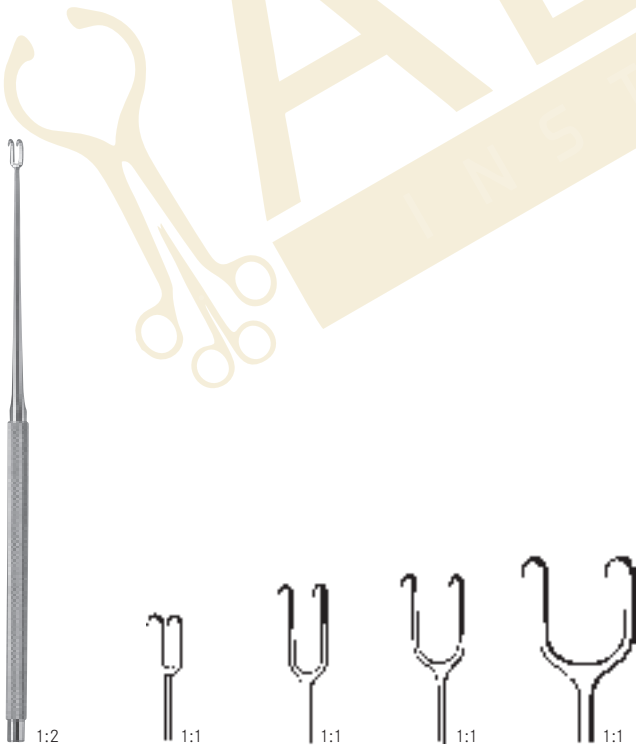

JOSEPH

	2 mm	5 mm	7 mm	10 mm
160 mm - 6 1/4"	AI 16910-02	AI 16910-05	AI 16910-07	AI 16910-10

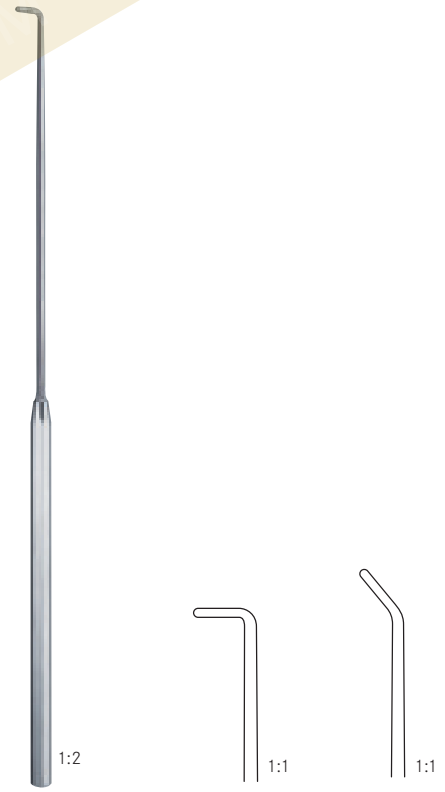

CRILE

	Fig. 1	Fig. 2
200 mm - 8"	AI 25308-01	AI 25308-02



Nasen- und Trachealhäkchen
Trachea and nose retractors

Ecarteurs nasales et trachéales
Separadores para la traquea y la nariz
Uncini tracheali e nasali



1:2

AUFRICHT

190 mm - 7½"

AI 16906-19



1:2

AUFRICHT

190 mm - 7½"

AI 16906-59



1:2

AUFRICHT

AI 17919-13

Nasenhaken
Nasal hook

Crochet pour le nez
Gancho para la nariz
Uncino nasale



1:2

CONVERSE

120 mm - 4¾"

AI 16908-12



Nasen- und Trachealhäkchen
Trachea and nose retractors

Ecarteurs nasales et trachéales
Separadores para la traquea y la nariz
Uncini tracheali e nasali



1:2

KILNER

100 mm - 4"

AI 16907-10



1:2

MARTINEZ KILNER

110 mm - 4¼"

AI 16907-12



1:2

COTTLE

AI 17750-00

Daumenhaken
Thumb hook

Crochet pour le doigt
Gancho para el dedo

Uncino da fissare sul pollice



Nasen- und Trachealhäkchen
Trachea and nose retractors

Ecarteurs nasales et trachéales
Separadores para la traquea y la nariz
Uncini tracheali e nasali

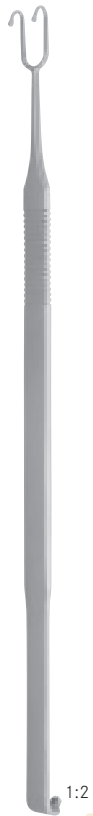

COTTLE-
NEIVERT

200 mm - 8"

AI 16912-20

1:2



FOMON

160 mm - 6 1/4"

AI 16914-16

1:2



COTTLE

150 mm - 6"

1:2



1:1

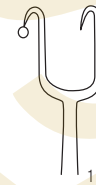

1:1



1:1

AI 16915-01

AI 16915-02

AI 16915-03

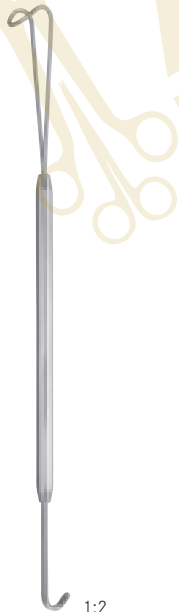

NEIVERT

160 mm - 6 1/4"

AI 16916-16

1:2



1:2



1:2

COTTLE

150 mm - 6"

AI 16917-15

AI 16918-15



ITERSON

160 mm - 6 1/4"

1:2



1:1



1:1

AI 16920-16

AI 16922-16



Trachealhäkchen
Trachea retractors

Ecarteurs nasales et trachéales
Separadores para la traquea
Uncini tracheali



1:2
JACKSON
150 mm - 6"
AI 16930-15



1:2
LUKENS
170 mm - 6 2/3"
AI 16933-17



1:2
JACKSON
170 mm - 6 2/3"
AI 16935-17



1:2

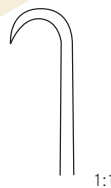

1:1



1:1



1:1

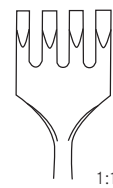

1:1

160 mm - 6 1/4"

AI 17001-16

AI 17002-16

AI 17003-16

AI 17004-16

scharf
sharp

pointu
agudo
acuto

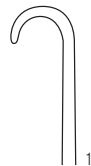

1:1



1:1



1:1

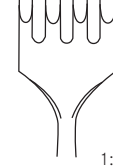

1:1

160 mm - 6 1/4"

AI 17011-16

AI 17012-16

AI 17013-16

AI 17014-16

stumpf
blunt

mousse
romo
smusso



Trachealhäkchen | Ecarteurs trachéales
Trachea retractors | *Separadores para la traquea*
 Uncini tracheali

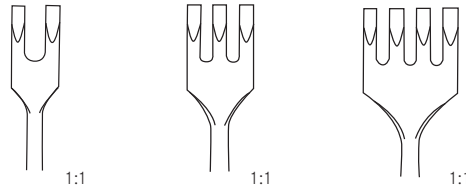

160 mm - 6 1/4"	AI 17021-16	AI 17022-16	AI 17024-16
-----------------	--------------------	--------------------	--------------------

flexibel, scharf
 flexible, sharp
 flexible, pointu
 flexible, agudo
 flessibile, acuto

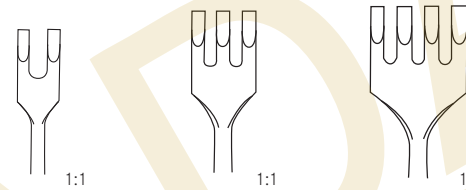

160 mm - 6 1/4"	AI 17031-16	AI 17032-16	AI 17034-16
-----------------	--------------------	--------------------	--------------------

flexibel, stumpf
 flexible, blunt
 flexible, mousse
 flexible, romo
 flessibile, smusso

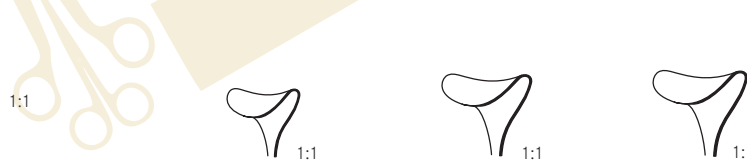

DESMARRES

	x = 8 mm	x = 10 mm	x = 12 mm
160 mm - 6 1/4"	AI 17038-08	AI 17038-10	AI 17038-12

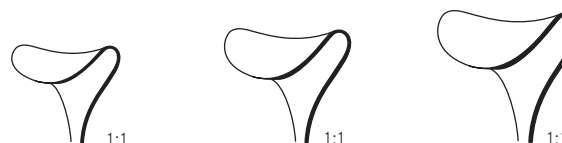

	x = 14 mm	x = 16 mm	x = 18 mm
160 mm - 6 1/4"	AI 17038-14	AI 17038-16	AI 17038-18

**KNAPP
 (ROLLET)**

160 mm - 6 1/4"	AI 17025-16
-----------------	--------------------

flexibel, scharf
 flexible, sharp
 flexible, pointu
 flexible, agudo
 flessibile, acuto



Brust Dissektoren | **Ecarteurs mammaires**
Mamaplasty retractors | **Separadores mamarias**
 | **Divaricatori per seno**

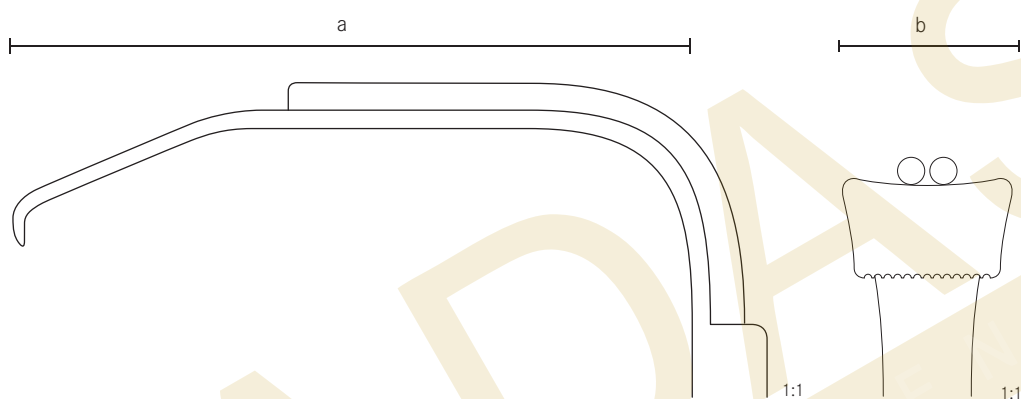

1:3

a	b	185 mm - 7/4"	185 mm - 7/4"
90 mm	24 mm	AI 17217-01	AI 17217-06
115 mm	24 mm	AI 17217-02	AI 17217-07
150 mm	25 mm	AI 17217-05	AI 17217-08
150 mm	36 mm	AI 17217-03	AI 17217-09
190 mm	30 mm	AI 17217-04	AI 17217-10

gezahnt und Kaltlichtbeleuchtung
toothed with fiber optic illumination
 dentelée avec illumination à lumière froide
dentada con iluminación de luz fría
 dentata con illuminazione a luce fredda

mit Spühhrohr
with irrigation tube
 avec tube de lavage
con tubo lavador
 con tubo di lavaggio

ohne Spühhrohr
without irrigation tube
 sans tube de lavage
sin tubo lavador
 senza tubo di lavaggio

a	b	185 mm - 7/4"	185 mm - 7/4"
90 mm	24 mm	AI 17217-21	AI 17217-26
115 mm	24 mm	AI 17217-22	AI 17217-27
150 mm	25 mm	AI 17217-25	AI 17217-28
150 mm	36 mm	AI 17217-23	AI 17217-29
190 mm	30 mm	AI 17217-24	AI 17217-30

ohne Zähne mit Kaltlichtbeleuchtung
non-toothed with fiber optic illumination
 sans denture avec illumination à lumière froide
sin dentada con iluminación de luz fría
 no dentata con illuminazione a luce fredda

mit Spühhrohr
with irrigation tube
 avec tube de lavage
con tubo lavador
 con tubo di lavaggio

ohne Spühhrohr
without irrigation tube
 sans tube de lavage
sin tubo lavador
 senza tubo di lavaggio



Brust Dissektoren
Mamaplasty retractors

Ecarteurs mammaires
Separadores mamarias
Divaricatori per seno

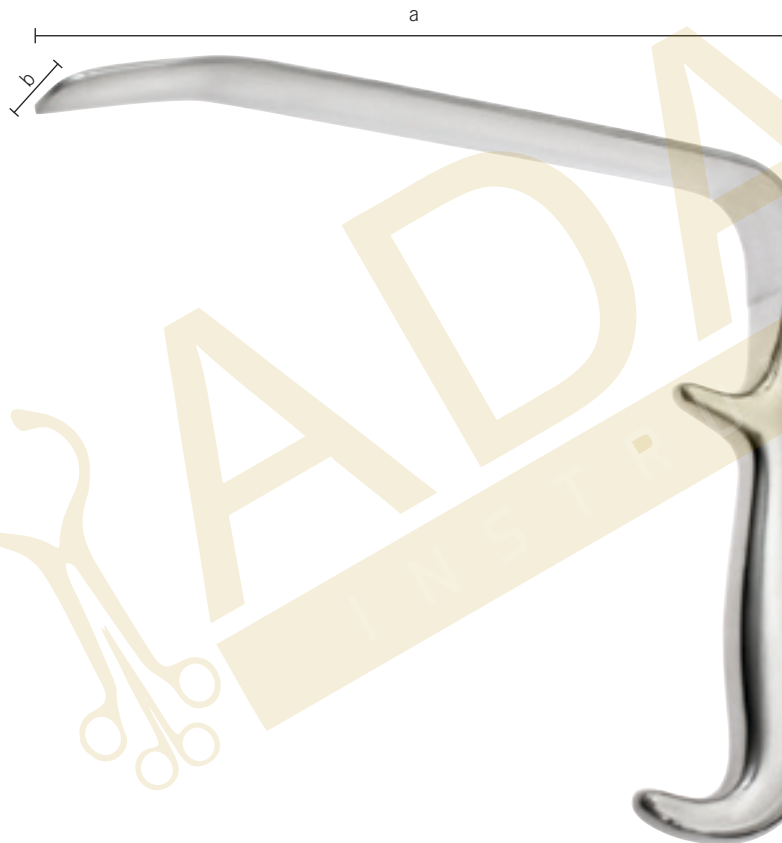

1:2

MACCOLLUM
DINGMAN

315 mm - 12½"

AI 16903-30

FERREIRA

a	b	185 mm - 7¼"	
90 mm	24 mm	AI 17219-01	AI 17219-06
115 mm	24 mm	AI 17219-02	AI 17219-07
150 mm	25 mm	AI 17219-03	AI 17219-08
150 mm	36 mm	AI 17219-04	AI 17219-09
190 mm	30 mm	AI 17219-05	AI 17219-10

Wundhaken
Retractors

Ecarteurs
Retradores
Divaricatori

ohne Zahnung
non - toothed
sans denture
sin dentada
no dentata

Gezahnt
toothed
denture
dentada
dentata



Brust Dissektoren
Mamaplasty retractors

 Ecarteurs mammaires
Separadores mamarias
 Divaricatori per seno

330 mm - 13"	AI 17156-08	AI 17156-10	AI 17156-12
420 mm - 16½"	AI 17156-09	AI 17156-11	AI 17156-13
abgewinkelt angled angulé <i>angulado</i> angolato	starr rigid rigide <i>rigido</i> rigido	biegsam malleable maléable <i>maleable</i> flessibile	Schaft isoliert Shaft insulated Tige isolée <i>Tija aislada</i> Asta isolata



330 mm - 13"	AI 17156-01	AI 17156-03	AI 17156-05
420 mm - 16½"	AI 17156-02	AI 17156-04	AI 17156-06
	starr rigid rigide <i>rigido</i> rigido	biegsam malleable maléable <i>maleable</i> flessibile	Schaft isoliert Shaft insulated Tige isolée <i>Tija aislada</i> Asta isolata



	x = 25 mm	x = 33 mm
315 mm - 12½"	AI 17156-20	AI 17156-21

 halbstarr
 semi rigid
 semi rigide
semi rigido
 semi rigido



Wundhaken
Retractors

Ecarteurs
Separadores
Divaricatori

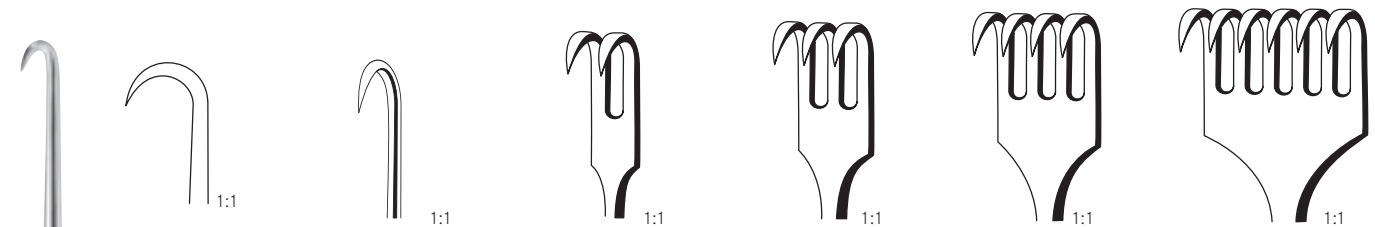

VOLKMANN

215 mm - 8½"	AI 17061-21	AI 17062-21	AI 17063-21	AI 17064-21	AI 17066-21
--------------	--------------------	--------------------	--------------------	--------------------	--------------------

scharf
sharp
pointu
agudo
acuto

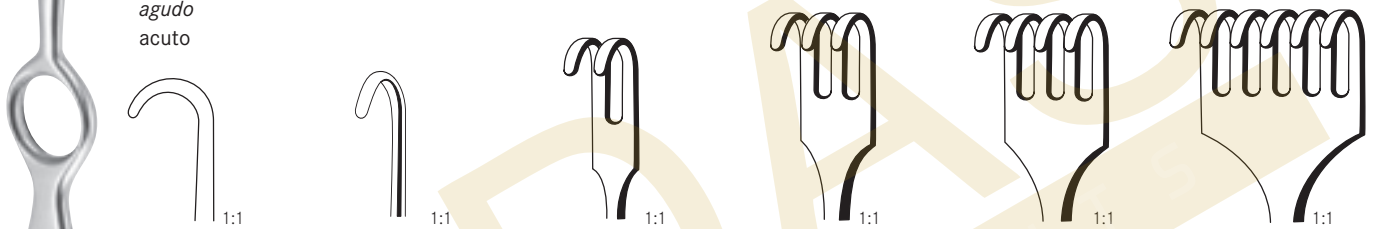

215 mm - 8½"	AI 17071-21	AI 17072-21	AI 17073-21	AI 17074-21	AI 17076-21
--------------	--------------------	--------------------	--------------------	--------------------	--------------------

stumpf
blunt
mousse
romo
smusso



1:2

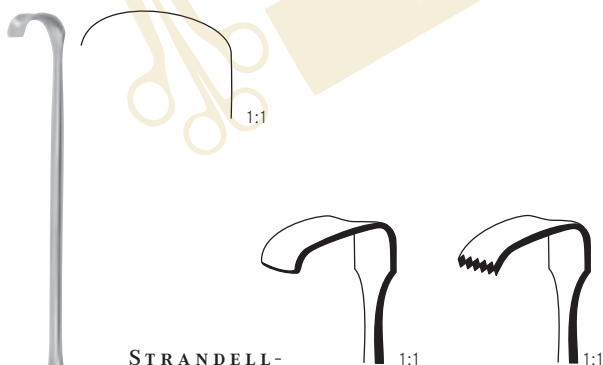

STRANDELL-STILLE

	Fig. 1	Fig. 2
190 mm - 7½"	AI 17079-01	AI 17079-02

gezahnt
saw edge
dentelé
dentado
dentato

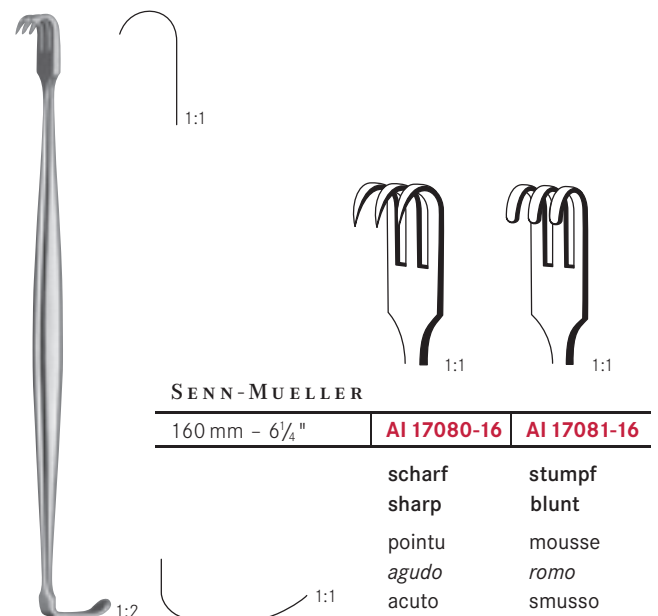

SENN-MUELLER

160 mm - 6¼"	AI 17080-16	AI 17081-16
--------------	--------------------	--------------------

scharf sharp pointu agudo acuto	stumpf blunt mousse romo smusso
---	---





Wundhaken - Wundspreizer
Retractors - Wound spreaders, self-retaining

Ecarteurs - Ecarteurs autostatiques
Separadores - Separadores autoestáticos
Divaricatori - Divaricatori autostatici



MEYERDING

	18 mm x 7 mm	10 mm x 3 mm
180 mm - 7"	AI 17090-18	AI 17091-18



	16 mm x 5 mm	7 mm x 4 mm
180 mm - 7"	AI 17092-18	AI 17093-18

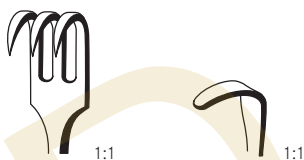

	10 mm x 4 mm	7 mm x 4 mm
180 mm - 7"	AI 17094-18	AI 17095-18



1:1
8 mm x 4 mm

RAGNELL-DAVIS

140 mm - 5½"	AI 17084-14
--------------	--------------------



15 mm x 5,5 mm



ALM

	4 x 4	4 x 4	4 x 4
70 mm - 2¾"	AI 17330-07	AI 17330-17	AI 17331-07
100 mm - 4"	AI 17330-10	AI 17330-20	AI 17331-10

scharf	halbscharf	stumpf
sharp	semi sharp	blunt
pointu	semi pointu	mousse
agudo	semi agudo	romo
acuto	semi acuto	smusso



HOLTZHEIMER

	4 x 4	4 x 4
100 mm - 4"	AI 17336-10	AI 17337-10

scharf	stumpf
sharp	blunt
pointu	mousse
agudo	romo
acuto	smusso



Wundhaken | Ecarteurs
Retractors | Separadores
Divaricatori



FREEMAN	
	x = 22 mm
100 mm - 4"	AI 17147-09

scharf
sharp
pointu
agudo
acuto



FREEMAN	
	x = 38 mm
100 mm - 4"	AI 17147-10

scharf
sharp
pointu
agudo
acuto



GORNEY	
	x = 38 mm
75 mm - 3"	AI 17148-38

scharf
sharp
pointu
agudo
acuto



Wundhaken
Retractors

Ecarteurs
Separadores
Divaricatori

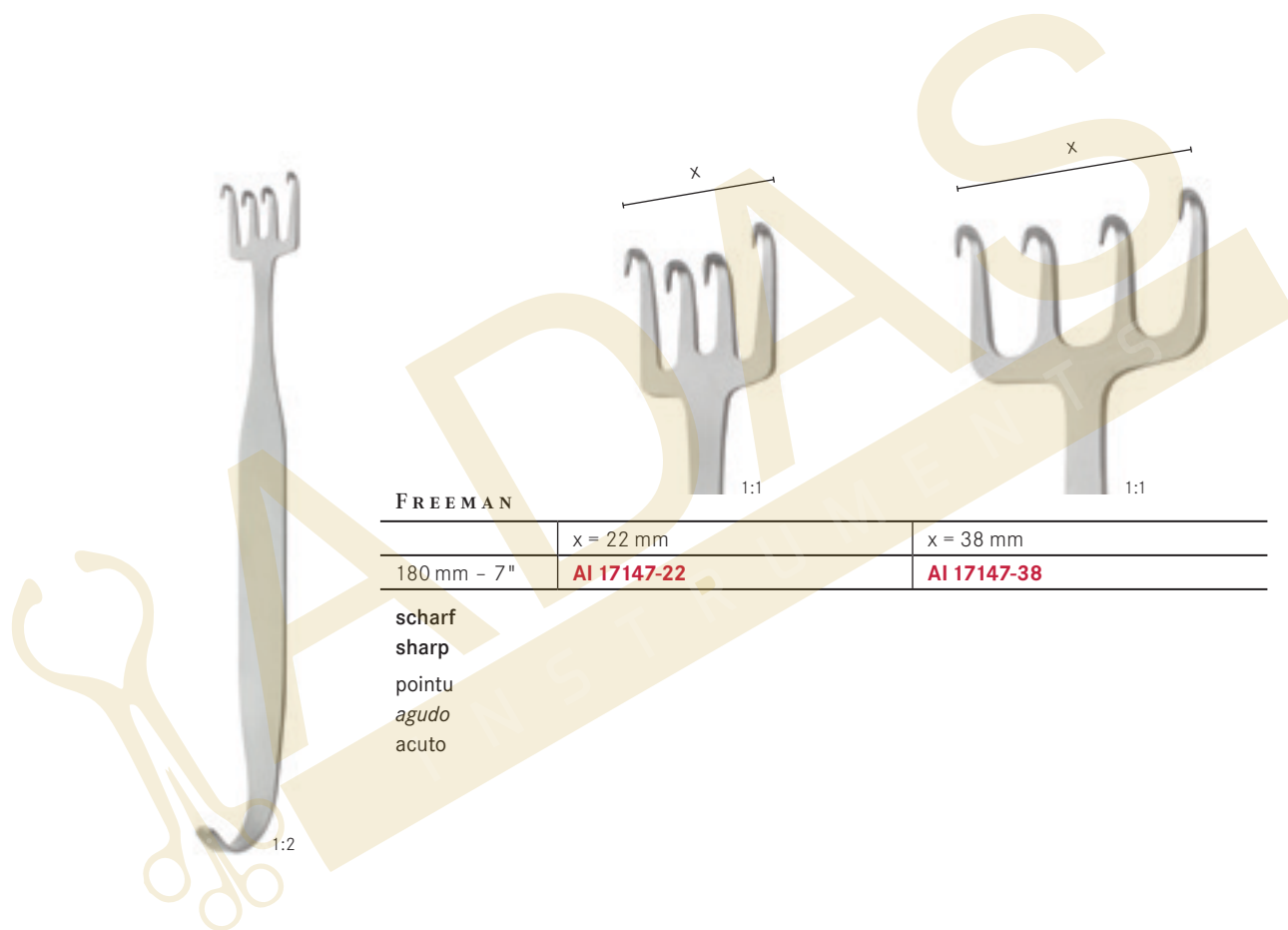

FREEMAN	x = 22 mm	x = 38 mm
180 mm - 7"	AI 17147-22	AI 17147-38

scharf
sharp
pointu
agudo
acuto



Wundhaken | Ecarteurs
Retractors | Separadores
Divaricatori



1:2

YANCOSKIE

	x = 150 mm
180 mm - 7"	AI 17144-15

scharf
sharp
pointu
agudo
acuto



1:2

CORONAL LIFT

	x = 70 mm
180 mm - 7"	AI 17145-18

scharf
sharp
pointu
agudo
acuto



Wundhaken | Ecarteurs
Retractors | Separadores
Divaricatori

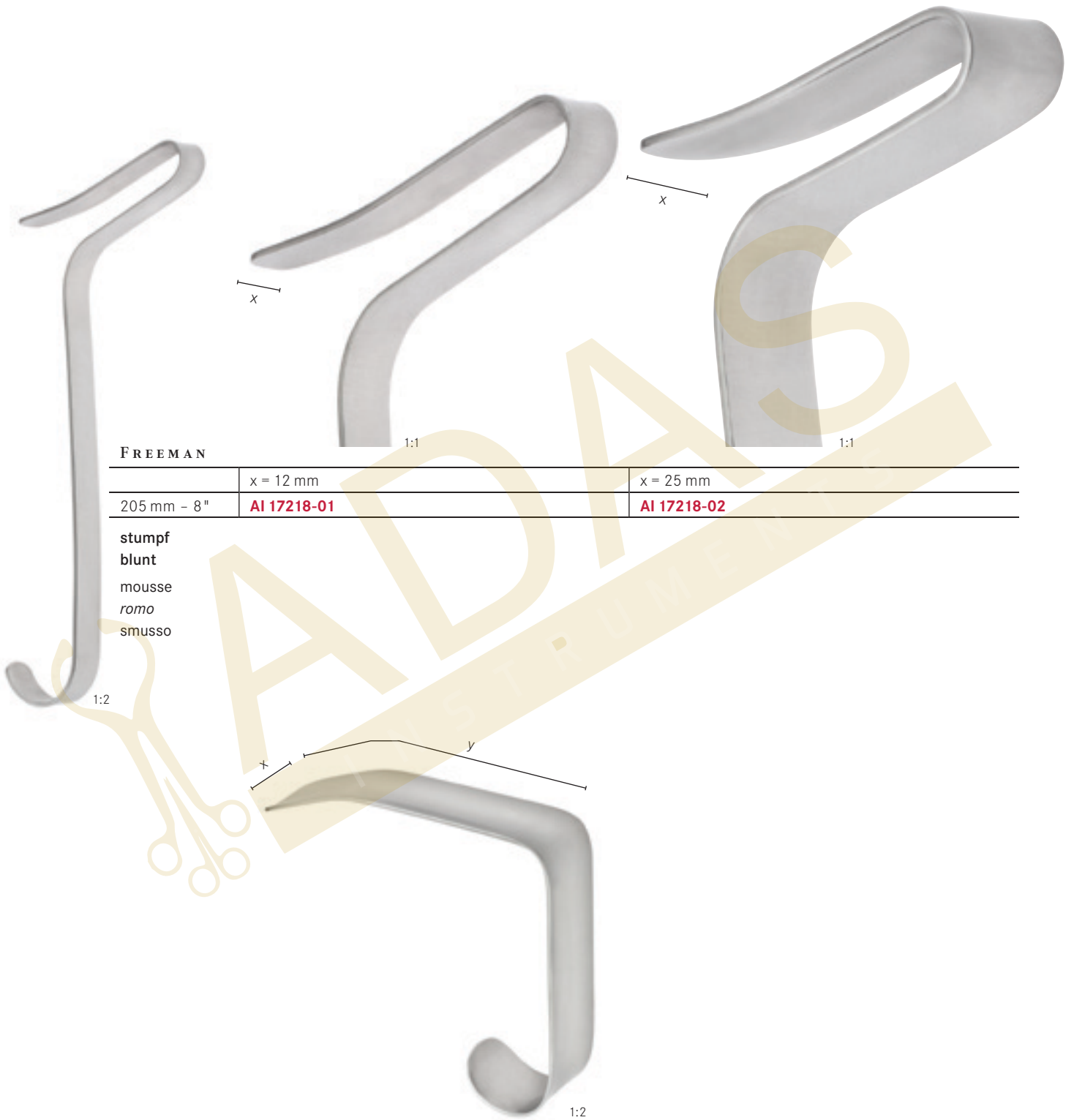

FREEMAN

	x = 12 mm	x = 25 mm
205 mm - 8"	AI 17218-01	AI 17218-02

stumpf
blunt
mousse
romo
smusso

FERREIRA

	x = 23 mm / y = 120 mm
100 mm - 4"	AI 17218-03

stumpf
blunt
mousse
romo
smusso



Weichteilhaken für die Kieferchirurgie
Soft tissue retractors for maxillo-facial surgery

Ecarteurs pour la chirurgie maxillo-faciale
Ganchos para cirugía maxilofacial
Uncini per chirurgia massilofaciale

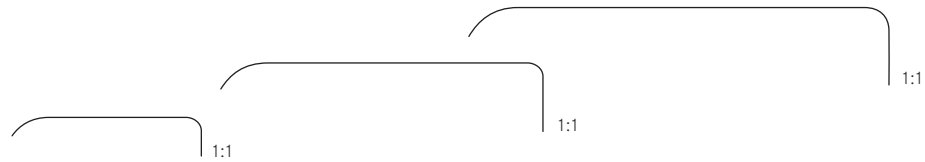

OBWEGESER

	7 mm x 25 mm	10 mm x 42 mm	12 mm x 55 mm
215 mm - 8½"	AI 17114-01	AI 17114-05	AI 17114-06

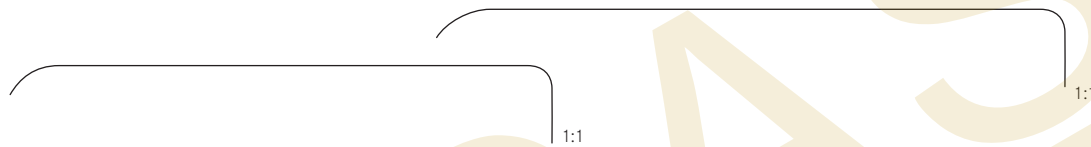

	14 mm x 70 mm	16 mm x 80 mm
215 mm - 8½"	AI 17114-07	AI 17114-09



1:3

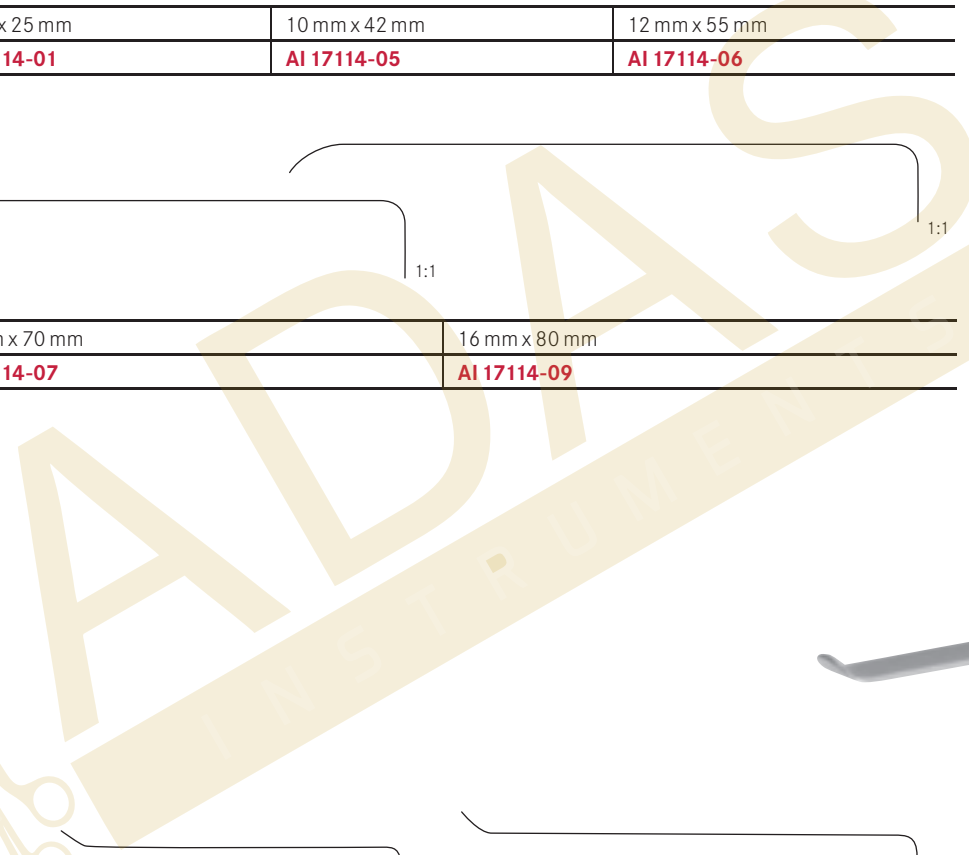

OBWEGESER

	13 mm x 42 mm	12 mm x 60 mm
220 mm - 8¾"	AI 52715-01	AI 52715-02

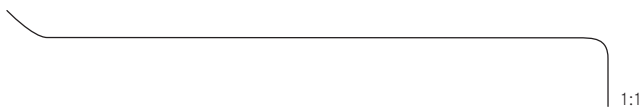

	16 mm x 80 mm
220 mm - 8¾"	AI 52715-03

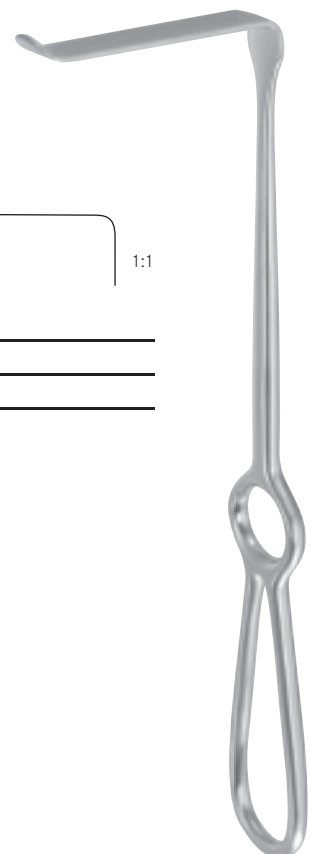

Weichteilhaken für die Kieferchirurgie
Soft tissue retractors for maxillo-facial surgery

Ecarteurs pour la chirurgie maxillo-faciale
Ganchos para cirugía maxilofacial
Uncini per chirurgia massilofaciale



OBWEGESER

	44 mm x 9,5 mm	70 mm x 11,5 mm
220 mm - 8 ³ / ₄ "	AI 52717-22	AI 52719-22

1:2

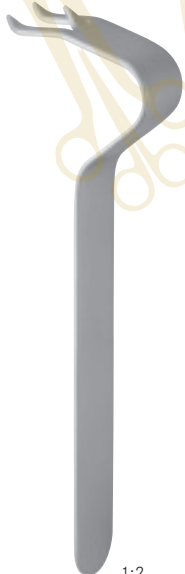

OBWEGESER

155 mm - 6"	AI 52723-16
-------------	--------------------

1:2



OBWEGESER

	8 mm	10 mm
160 mm - 6 ¹ / ₄ "	AI 52725-08	AI 52725-10

1:2

biegsam
malleable
malléable
flexible
flessibile



Wundhaken - Wundsperrer
Retractors - Wound spreaders, self-retaining

Ecarteurs - Ecarteurs autostatiques
Separadores - Separadores autoestáticos
Divaricatori - Divaricatori autostatici



WEITLANER-LOKTITE

105 mm - 4 1/4"	AI 17400-10	AI 17400-20	AI 17401-10
	scharf sharp pointu agudo acuto	halbscharf semi sharp semi pointu semi agudo semi acuto	stumpf blunt mousse romo smusso



WEITLANER-LOKTITE

130 mm - 5"	AI 17402-13	AI 17402-23	AI 17403-13
165 mm - 6 1/2"	AI 17402-16	AI 17402-26	AI 17403-16
200 mm - 8"	AI 17404-20	AI 17404-30	AI 17405-20
260 mm - 10 1/4"	AI 17404-26	AI 17404-36	AI 17405-26
	scharf sharp pointu agudo acuto	halbscharf semi sharp semi pointu semi agudo semi acuto	stumpf blunt mousse romo smusso



Wundhaken - Wundsperrer
Retractors - Wound spreaders, self-retaining

Ecarteurs - Ecarteurs autostatiques
Separadores - Separadores autoestáticos
Divaricatori - Divaricatori autostatici



1:2

WULLSTEIN

100 mm - 4"	AI 17408-01	AI 17408-02
-------------	--------------------	--------------------

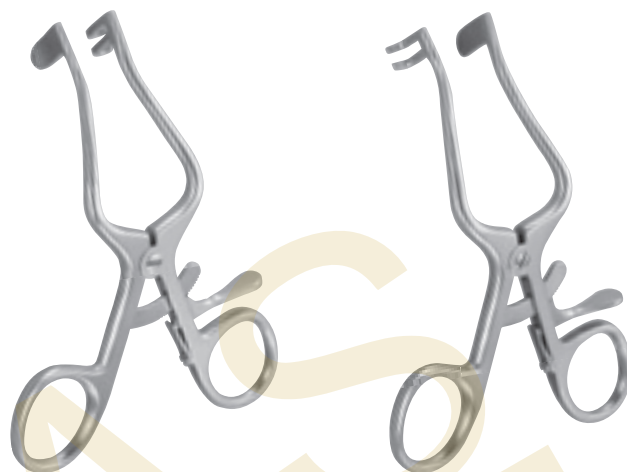

BELUCCI

110 mm - 4 1/4"	AI 17410-11	AI 17411-11
130 mm - 5"	AI 17410-13	AI 17411-13

links, stumpf
left, blunt
gauche, mousse
izquierda, romo
sinistra, smusso

rechts, stumpf
right, blunt
droit, mousse
derecha, romo
destra, smusso

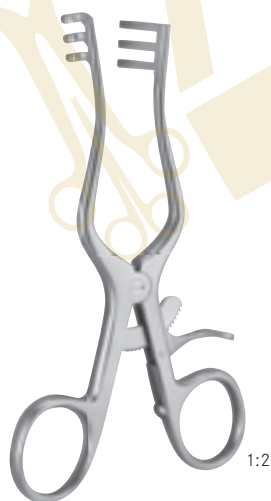

1:2

MILIGAN

130 mm - 5"	AI 17409-13
-------------	--------------------

stumpf
blunt
mousse
romo
smusso



1:2

TRAVERS

205 mm - 8 1/2"	AI 17412-20
-----------------	--------------------

stumpf
blunt
mousse
romo
smusso



Nadelhalter | Porte-aiguilles
Needle holders | Porta-agujas
Porta aghi

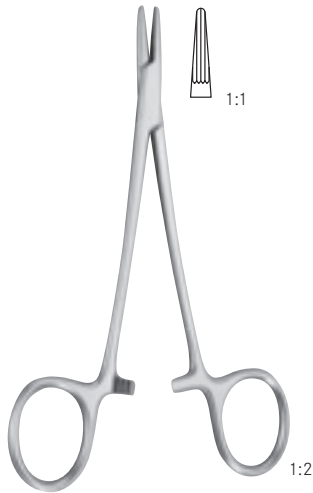

DERF

125 mm - 5"

AI 20308-12

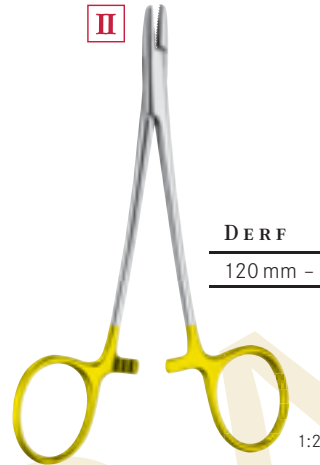

DERF

120 mm - 4 3/4"

AI 20008-12

AI 20508-12 TC

ein Maul gefenstert
one fenestrated jaw
une coté du mors fenêtré
un lado de la boca fenestrada
una parte del morso fenestrado



CRILE-MURRAY

150 mm - 6"

AI 20001-15



CRILE-WOOD

150 mm - 6"

AI 20002-15

AI 20502-15 TC

180 mm - 7"

AI 20002-18

AI 20502-18 TC

200 mm - 8"

tk20002-20

AI 20502-20 TC



Nadelhalter
Needle holders

Porte-aiguilles
Porta-agujas
Porta aghi

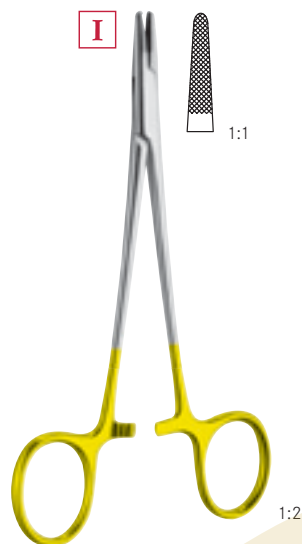

HEGAR-BAUMGARTNER

140 mm - 5 3/4"	AI 20003-14
140 mm - 5 3/4"	AI 20503-14 TC



BABY-CRILE-WOOD

150 mm - 6"	AI 20504-15 TC
-------------	-----------------------

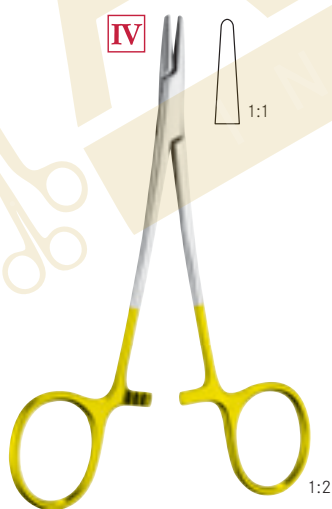

WEBSTER

130 mm - 5"	AI 20009-13
130 mm - 5"	AI 20509-13 TC

glatt
smooth
lisse
liso
liscio



MATHIEU-OLSEN

140 mm - 5 1/2"	AI 20106-14	AI 20516-14 TC
170 mm - 6 3/4"	AI 20106-17	AI 20516-17 TC
200 mm - 8"	AI 20106-20	AI 20516-20 TC



Nadelhalter | Porte-aiguilles
Needle holders | Porta-agujas
Porta aghi

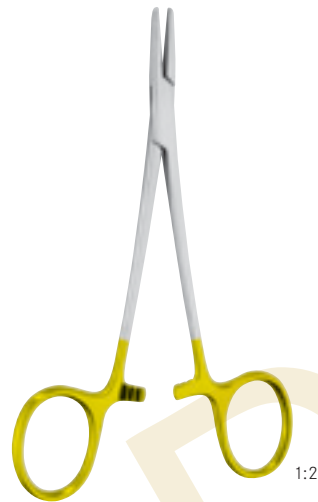

HALSEY

130 mm - 5"	AI 20010-13	AI 20011-13
130 mm - 5"	AI 20510-13 TC	AI 20511-13 TC

glatt
smooth
lisse
liso
liscio

gerieft
serrated
strié
estriada
zigrinato



II

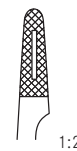

OLSEN-HEGAR

120 mm - 4 ³ / ₄ "	AI 20036-12	AI 20536-12 TC
140 mm - 5 ¹ / ₂ "	AI 20036-14	AI 20536-14 TC
170 mm - 6 ³ / ₄ "	AI 20036-17	AI 20536-17 TC
190 mm - 7 ¹ / ₂ "	AI 20036-19	AI 20536-19 TC



Nadelhalter | Porte-aiguilles
Needle holders | Porta-agujas
Porta aghi

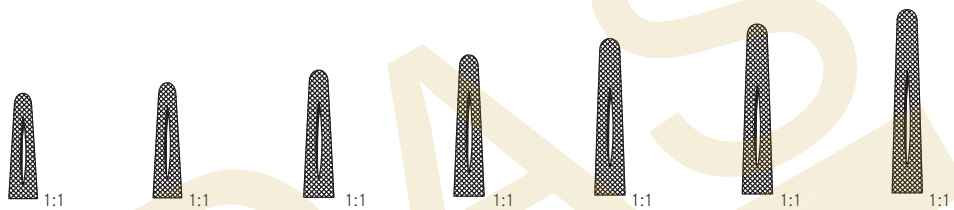

MAYO-HEGAR

140mm - 5½"	160mm - 6¼"	180mm - 7"	200mm - 8"	240mm - 9½"	260mm - 10¼"	300mm - 12"
AI 20012-14	AI 20012-16	AI 20012-18	AI 20012-20	AI 20012-24	AI 20012-26	AI 20012-30

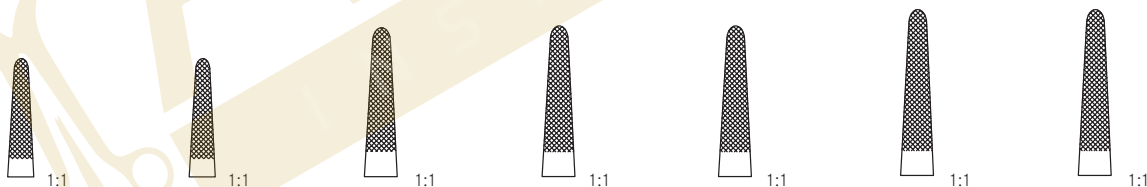

MAYO-HEGAR

140 mm - 5½"	160 mm - 6¼"	180 mm - 7"	200 mm - 8"	240 mm - 9½"	260 mm - 10¼"	300 mm - 12"
AI 20512-14 TC	AI 20512-16 TC	AI 20512-18 TC	AI 20512-20 TC	AI 20512-24 TC	AI 20512-26 TC	AI 20512-30 TC



Nadelhalter | Porte-aiguilles
Needle holders | Porta-agujas
Porta aghi

II



GILLIES

160 mm - 6¼"	AI 20035-16	AI 20535-16 TC
--------------	--------------------	-----------------------



1:1



1:1

1:2

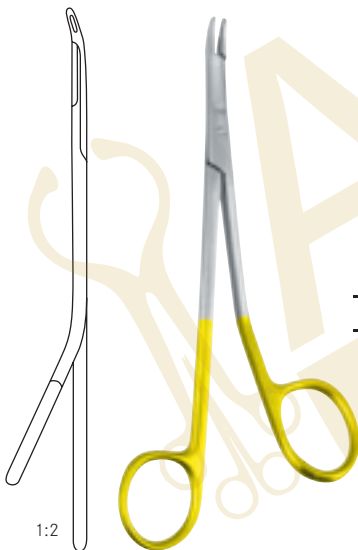

GILLIES

145 mm - 5¾"	AI 20035-14	AI 20535-14 TC
--------------	--------------------	-----------------------



1:1



1:1

1:2

1:2



FOSTER-GILLIES

120 mm - 4¾"	AI 20546-12 TC	AI 20548-12 TC	AI 20547-12 TC	AI 20549-12 TC
--------------	-----------------------	-----------------------	-----------------------	-----------------------



1:2



1:2



1:2



1:2

gerade, gerieft
straight, serrated
droit, strié
recta, estriada
retto, zigrinato

gerade, glatt
straight, smooth
droit, lisse
recta, lisa
retto, liscio

gebogen, gerieft
curved, serrated
courbe, strié
curva, estriada
curvo, zigrinato

gebogen, glatt
curved, smooth
courbe, lisse
curva, lisa
curvo, liscio



Nadelhalter | Porte-aiguilles
Needle holders | Porta-agujas
Porta aghi

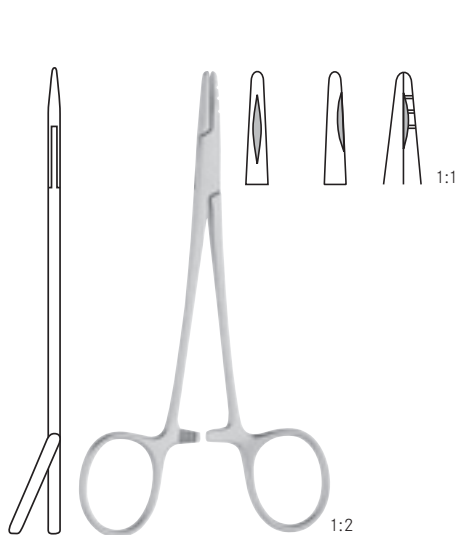

NEIVERT
125 mm - 5"
AI 20304-13

II

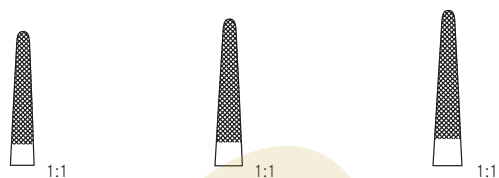
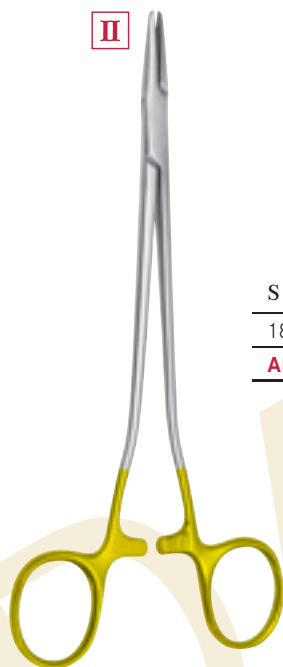

SAROT

180 mm - 7"	200 mm - 8"	260 mm - 10¼"
AI 20524-18 TC	AI 20524-20 TC	AI 20524-26 TC

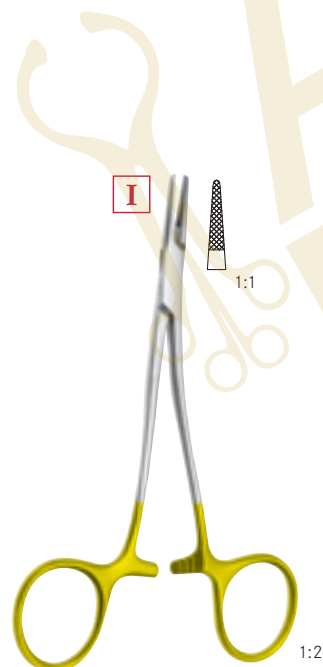

KILNER
135 mm - 5¼"
AI 20533-13 TC

I

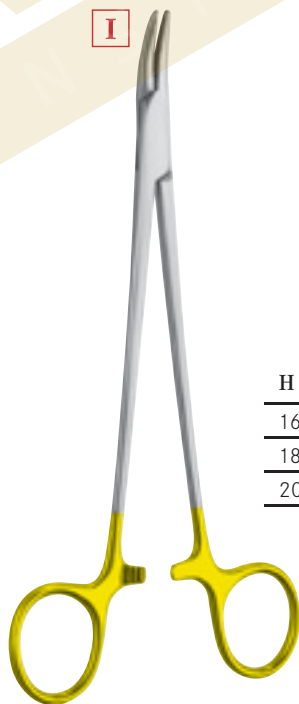

HEANEY

160 mm - 6¼"	AI 20515-16 TC
180 mm - 7"	AI 20515-18 TC
200 mm - 8"	AI 20515-20 TC



Nadelhalter | Porte-aiguilles
Needle holders | Porta-agujas
Porta aghi

II

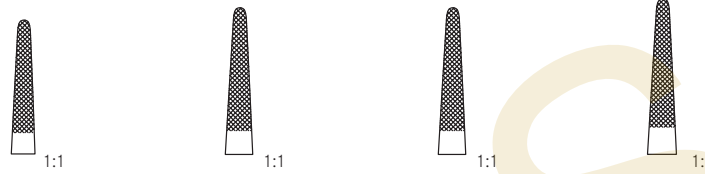

DE BAKEY

180 mm - 7"	200 mm - 8"	230 mm - 9"	260 mm - 10¼"
AI 20522-18 TC	AI 20522-20 TC	AI 20522-23 TC	AI 20522-26 TC

III

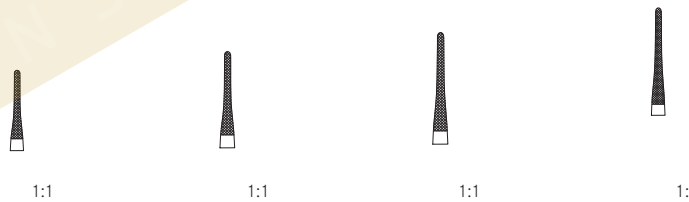

VASCULAR

140 mm - 5½"	180 mm - 7"	200 mm - 8"	230 mm - 9"
AI 20525-14 TC	AI 20525-18 TC	AI 20525-20 TC	AI 20525-23 TC



Nadelhalter | Porte-aiguilles
 Needle holders | Porta-agujas
 Porta aghi



1:1



1:1



1:1

130 mm - 5"

AI 20570-13

 150 mm - 5³/₄"

AI 20570-15

 170 mm - 6³/₄"

AI 20570-17

mit Spezialbeschichtung im Maul
 with special coated jaw

mors avec couche special
 boca con capa especial
 morso "diamant dust"



1:1



1:1



1:1

180 mm - 7"

AI 20570-18

200 mm - 8"

AI 20570-20

230 mm - 9"

AI 20570-23

mit Spezialbeschichtung im Maul
 with special coated jaw

mors avec couche special
 boca con capa especial
 morso "diamant dust"



Beschichtung mit Hartmetallstaub.

Sicheres Halten der Nadel

Speziell geeignet für feine Nadelhalter, keine Bruchgefahr der Maulspitzen.

Jaws coated with carbide dust.

Secure fixing of the needle.

Suitable for delicate needle-holders, no risk of breakage of the jaws

Mors recouverts de poussière de carbure.

Tenu sûre de l'aiguille.

Spécialement approprié pour des port-aiguilles fins, pas de risque des ruptures des mors.

Bocas revestidas con polvo de carburo.

Fija seguramente la aguja.

Apto para porta-agujas delicados, ningún riesgo de roturas de las bocas.

Morsi rivestiti con polvere di carburo.

Regge sicuramente l'ago.

Appropriato particolarmente per porta-aghi sottili, senza rischio per rottura di morso.



Nadelhalter | Porte-aiguilles
Needle holders | Porta-agujas
Porta aghi

II



LICHTENBERG

170 mm - 6 3/4"	AI 20615-17 TC		AI 20115-17
200 mm - 8"		AI 20615-20 TC	AI 20115-20

III



DIETRICH

160 mm - 6 1/4"	AI 20560-16 TC
180 mm - 7"	AI 20560-18 TC
200 mm - 8"	AI 20560-20 TC
230 mm - 9"	AI 20560-23 TC
250 mm - 9 3/4"	AI 20560-25 TC

II



III



RYDER

130 mm - 5"	AI 20540-13 TC	AI 20541-13
150 mm - 6"	AI 20540-15 TC	AI 20541-15
180 mm - 7"	AI 20540-18 TC	AI 20541-18
200 mm - 8"	AI 20540-20 TC	AI 20541-20
230 mm - 9"	AI 20540-23 TC	AI 20541-23
260 mm - 10 1/4"	AI 20540-26 TC	

MINI-RYDER

AI 20542-13 TC
AI 20542-15 TC
AI 20542-18 TC
AI 20542-20 TC
AI 20542-23 TC
AI 20542-26 TC



mit Spezialbeschichtung im Maul
with special coated jaw
Mors avec couche special
Boca con capa especial
Morso "diamant dust"



Nadelhalter | Porte-aiguilles
 Needle holders | Porta-agujas
 Porta aghi



IV

**CASTROVIEJO-
 JACOBSON**

140 mm - 5½"			AI 20210-14	AI 20710-14 TC
150 mm - 6"	AI 20204-15	AI 20704-15 TC	AI 20210-15	AI 20710-15 TC
180 mm - 7"	AI 20204-18	AI 20704-18 TC	AI 20210-18	AI 20710-18 TC
210 mm - 8¼"	AI 20204-21	AI 20704-21 TC	AI 20210-21	AI 20710-21 TC

 glattes Maul
 smooth jaws

mors lisse

boca lisa

morso liscio

 gerade, ohne Sperre
 straight, without ratchet

droit, sans crémaillère

recta, sin cremallera

retto, senza cremagliera

 gerade, mit Sperre
 straight, with ratchet

droit, avec crémaillère

recta, con cremallera

retto, con cremagliera



140 mm - 5½"			AI 20211-14	AI 20711-14 TC
150 mm - 6"	AI 20205-15	AI 20705-15 TC	AI 20211-15	AI 20711-15 TC
180 mm - 7"	AI 20205-18	AI 20705-18 TC	AI 20211-18	AI 20711-18 TC
210 mm - 8¼"	AI 20205-21	AI 20705-21 TC	AI 20211-21	AI 20711-21 TC

 glattes Maul
 smooth jaws

mors lisse

boca lisa

morso liscio

 gebogen, ohne Sperre
 curved, without ratchet

courbe, sans crémaillère

curva, sin cremallera

curvo, senza cremagliera

 gebogen, mit Sperre
 curved, with ratchet

courbe, avec crémaillère

curva, con cremallera

curvo, con cremagliera



1:2

BARRAQUER

1:1



1:1

145 mm - 5¾"	AI 20200-14	AI 20201-14
--------------	-------------	-------------

 gerade
 straight

droit

recta

retto

 gebogen
 curved

courbe

curva

curvo



Mikronadelhalter | Micro porte aiguilles
Micro needle holders | *Micro porta agujas*
 | Micro porta aghi



CASTROVIEJO

x = 11.0 mm x 0.75 mm				
140 mm - 5½ " "	AI 40910-14	AI 40911-14	AI 40912-14	AI 40913-14
ohne Sperre, feines Maul without ratchet, fine jaws sans crémaillère, mors fine <i>sin cremallera, boca fina</i> senza cremagliera, morso fino	gerade straight droit <i>recta</i> retto	gebogen diamond coated courbe <i>curva</i> curvo	gerade, straight, curved, diamond coated droit, diamanté <i>recta, diamantada</i> retto, diamantato	courbe, diamanté <i>curva, diamantada</i> curvo, diamantato
x = 11.0 mm x 0.75 mm				
140 mm - 5½ " "	AI 40915-14	AI 40917-14	AI 40918-14	AI 40919-14

mit Sperre, feines Maul with ratchet, fine jaws avec crémaillère, mors fine <i>con cremallera, boca fina</i> con cremagliera, morso fino	straight droit <i>recta</i> retto	curved diamond courbe <i>curva</i> curvo	straight, coated droit, diamanté <i>recta, diamantada</i> retto, diamantato	curved diamond straight, coated courbe, diamanté <i>curva, diamantada</i> curvo, diamantato
--	--	---	--	--









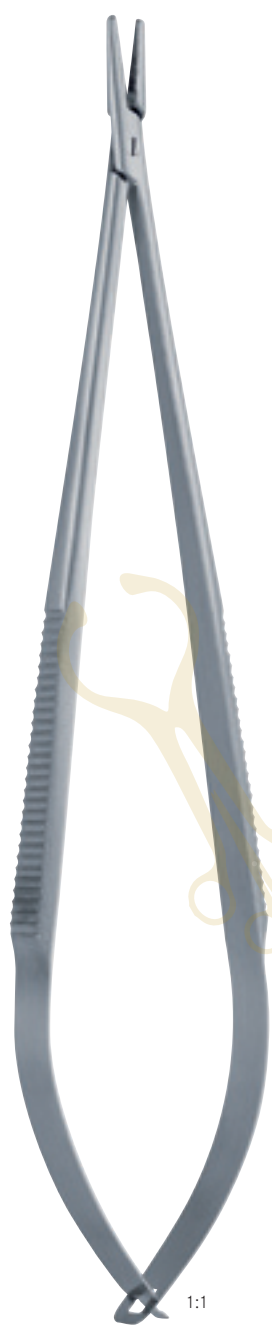

1:1



Mikronadelhalter | Micro porte aiguilles
Micro needle holders | *Micro porta agujas*
 | Micro porta aghi







	 1:1	 1:1	 1:1	 1:1
JACOBSON	x = 1 mm	x = 1 mm	x = 1 mm	x = 1 mm
180 mm - 7"	AI 25740-01	AI 25740-02	AI 25740-13	AI 25740-14
without ratchet	straight	curved	diamond straight,	diamond coated
sans crémaillère	droit	courbe	droit, diamanté	courbe, diamanté
sin cremallera	recta	curva	recta, diamantada	curva, diamantada
senza cremagliera	retto	curvo	retto, diamantato	curvo, diamantato
	x = 1 mm	x = 1 mm	x = 1 mm	x = 1 mm
180 mm - 7"	AI 25740-03	AI 25740-04	AI 25740-15	AI 25740-16
with ratchet	straight	curved	diamond coated	raight,diamond coated
avec crémaillère	droit	courbe	droit, diamanté	courbe, diamanté
con cremallera	recta	curva	recta, diamantada	curva, diamantada
con cremagliera	retto	curvo	retto, diamantato	curvo, diamantato
	 1:1	 1:1	 1:1	 1:1
	x = 1 mm	x = 1 mm	x = 1 mm	x = 1 mm
180 mm - 7"	AI 25740-05 tucar	AI 25740-06 tucar	AI 25740-09 tucar	AI 25740-10 tucar
ohne Sperre	glatte,	gebogen,	gerad,	gebogen,
without ratchet	straight	curved	straight	curved
sans crémaillère	droit, lisse	courbe, lisse	droit, strié	courbe, strié
sin cremallera	recta, liso	curva, lisa	recta, estriada	curva, estriada
senza cremagliera	retto, liscio	curvo, liscio	retto, zigrinato	curvo, zigrinato
	x = 1 mm	x = 1 mm	x = 1 mm	x = 1 mm
180 mm - 7"	AI 25740-07 tucar	AI 25740-08 tucar	AI 25740-11 tucar	AI 25740-12 tucar
1 mm				
mit Sperre	glatte,	gebogen,	gerad,	gebogen,
with ratchet	straight	curved	straight	curved
avec crémaillère	droit, lisse	courbe, lisse	droit, strié	courbe, strié
con cremallera	recta, liso	curva, lisa	recta, estriada	curva, estriada
con cremagliera	retto, liscio	curvo, liscio	retto, zigrinato	curvo, zigrinato



Mikronadelhalter mit Rundgriff
Micro needle holders with round handle

Micro porte aiguilles avec manche ronde
Micro porta agujas con mango redondo
Micro porta aghi con manico rotondo

BARRAQUER		 1:1	 1:1	 1:1	 1:1
140 mm - 5½ "	8 mm Ø	AI 25622-01	AI 25622-02	AI 25622-05	AI 25622-06
without ratchet, extra delicate jaws sans crémaillère, mors très fine <i>sin cremallera, boca muy fina</i> senza cremagliera, morso molto fino	straight droit <i>recta</i> retto	curved diamond courbe <i>curva</i> curvo	straight, coated droit, diamanté <i>recta, diamantada</i> retto, diamantato	curved, diamond coated courbe, diamanté <i>curva, diamantada</i> curvo, diamantato	
140 mm - 5½ "	8 mm Ø	AI 25622-03	AI 25622-04	AI 25622-07	AI 25622-08
with ratchet, extra delicate jaws avec crémaillère, mors très fine <i>con cremallera, boca muy fina</i> con cremagliera, morso molto fino	straight droit <i>recta</i> retto	curved diamond courbe <i>curva</i> curvo	straight, coated droit, diamanté <i>recta, diamantada</i> retto, diamantato	curved, diamond coated courbe, diamanté <i>curva, diamantada</i> curvo, diamantato	



1:1



Mikronadelhalter mit Rundgriff
Micro needle holders with round handle

 Micro porte aiguilles avec manche ronde
Micro porta agujas con mango redondo
 Micro porta aghi con manico rotondo

110 mm - 4 $\frac{1}{4}$ "	8 mm Ø	AI 25637-11	AI 25638-11
125 mm - 5 "	7 mm Ø	AI 25654-12	AI 25655-12
130 mm - 5 "	8 mm Ø	AI 25658-13	AI 25659-13
130 mm - 5 "	10 mm Ø	AI 25652-13	AI 25653-13
150 mm - 6 "	8 mm Ø	AI 25640-15	AI 25641-15
180 mm - 7 "	8 mm Ø	AI 25664-18	AI 25665-18
180 mm - 7 "	10 mm Ø	AI 25668-18	AI 25669-18

ohne Sperre
 without ratchet
 sans crémaillère
sin cremallera
 senza cremagliera

gerade
 straight
 droit
recta
 retto

gebogen
 curved
 courbe
curva
 curvo

110 mm - 4 $\frac{1}{4}$ "	8 mm Ø	AI 25635-11	AI 25636-11
125 mm - 5 "	7 mm Ø	AI 25656-12	AI 25657-12
130 mm - 5 "	8 mm Ø	AI 25662-13	AI 25663-13
130 mm - 5 "	10 mm Ø	AI 25645-13	AI 25646-13
150 mm - 6 "	8 mm Ø	AI 25642-15	AI 25643-15
180 mm - 7 "	8 mm Ø	AI 25666-18	AI 25667-18
180 mm - 7 "	10 mm Ø	AI 25670-18	AI 25671-18

mit Sperre
 with ratchet
 avec crémaillère
con cremallera
 con cremagliera

gerade
 straight
 droit
recta
 retto





gebogen
 curved
 courbe
curva
 curvo



Mikronadelhalter mit Rundgriff
Micro needle holders with round handle

Micro porte aiguilles avec manche ronde
Micro porta agujas con mango redondo
Micro porta aghi con manico rotondo



YASARGIL	 1:1	 1:1	 1:1	 1:1
	x = 1 mm	x = 1 mm	x = 1 mm	x = 1 mm
210 mm - 8 3/4 " "	AI 25623-01	AI 25623-02	AI 25623-13	AI 25623-14
ohne Sperre without ratchet sans crémaillère <i>sin cremallera</i> senza cremagliera	gerade straight droit <i>recta</i> retto	gebogen curved courbe <i>curva</i> curvo	gerade straight droit, diamanté <i>recta, diamantado</i> retto, diamantato	gebogen curved courbe, diamanté <i>curva, diamantado</i> curvo, diamantato
	x = 1 mm	x = 1 mm	x = 1 mm	x = 1 mm
210 mm - 8 3/4 " "	AI 25623-03	AI 25623-04	AI 25623-15	AI 25623-16
mit Sperre with ratchet avec crémaillère <i>con cremallera</i> con cremagliera	gerade straight droit <i>recta</i> retto	gebogen curved courbe <i>curva</i> curvo	gerade straight droit, diamanté <i>recta, diamantado</i> retto, diamantato	gebogen curved courbe, diamanté <i>curva, diamantado</i> curvo, diamantato
	x = 1 mm	x = 1 mm	x = 1 mm	x = 1 mm
210 mm - 8 3/4 " "	AI 25623-05 tucar	AI 25623-06 tucar	AI 25623-09 tucar	AI 25623-10 tucar
without ratchet	straight smooth	curved smooth	straight, serrated	curved serrated
sans crémaillère <i>sin cremallera</i> senza cremagliera	droit, lisse <i>recta, lisa</i> retto, liscio	courbe, lisse <i>curva, lisa</i> curvo, liscio	droit, strié <i>recta, estriada</i> retto, zigrinato	courbe, strié <i>curva, estriada</i> curvo, zigrinato
	x = 1 mm	x = 1 mm	x = 1 mm	x = 1 mm
210 mm - 8 3/4 " "	AI 25623-07 tucar	AI 25623-08 tucar	AI 25623-11 tucar	AI 25623-12 tucar
without ratchet	straight smooth	curved smooth	straight, serrated	curved serrated
avec crémaillère <i>con cremallera</i> con cremagliera	droit, lisse <i>recta, lisa</i> retto, liscio	courbe, lisse <i>curva, lisa</i> curvo, liscio	droit, strié <i>recta, estriada</i> retto, zigrinato	courbe, strié <i>curva, estriada</i> curvo, zigrinato



Auf Anfrage mit kräftigem Maul 1.5 mm - 2.0 mm lieferbar.
On request also available with stronger jaw 1.5 mm - 2.0 mm.

Egalement disponible avec mors plus gros 1.5mm - 2.0 mm.
También disponible con boca mas fuerte 1.5mm - 2.0 mm.

A richiesta fornibile anche con morso più forte di mm 1.5 a mm 2.0.



Mikronadelhalter | Micro porte aiguilles
 Micro needle holders | *Micro porta agujas*
 Micro porta aghi

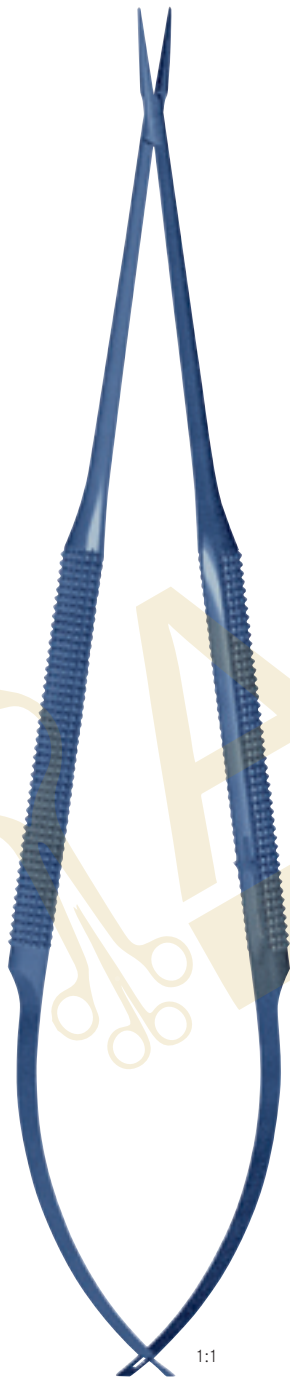

	0.4 x 0.6 mm	0.4 x 0.6 mm	0.6 x 0.6 mm	0.6 x 0.6 mm
200 mm - 8"	AI 25685-13	AI 25685-14	AI 25685-15	AI 25685-16

Titan, mit Sperre
 Titanium, with ratchet
 Titane, avec crémaillère
 Titanio, con cremallera
 Titanio, con cremagliera



Mikronadelhalter
Micro needle holders

Micro porte aiguilles
Micro porta agujas
Micro porta aghi



	0.3 mm x 0.4 mm	0.3 mm x 0.4 mm
180 mm - 7"	AI 25685-07	AI 25685-08

Titan, mit Sperre
Titanium, with ratchet
Titane, avec crémaillère
Titanio, con cremallera
Titanio, con cremagliera

1:2



	0.8 mm x 0.8 mm	0.8 mm x 0.8 mm
185 mm - 7 1/4 "	AI 25685-09	AI 25685-10

Titan, mit Sperre
Titanium, with ratchet
Titane, avec crémaillère
Titanio, con cremallera
Titanio, con cremagliera

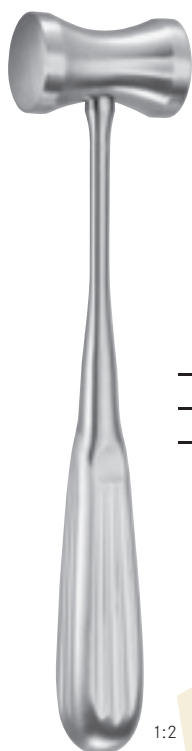

Hämmer | Maillets
Mallets | *Martillos*
Martelli

H A J E K

	27 mm Ø - 140 g
215 mm - 8½"	AI 24047-21

Stahl massiv
Steel solid
Acier solide
Acero solido
Acciaio massiccio

1:2

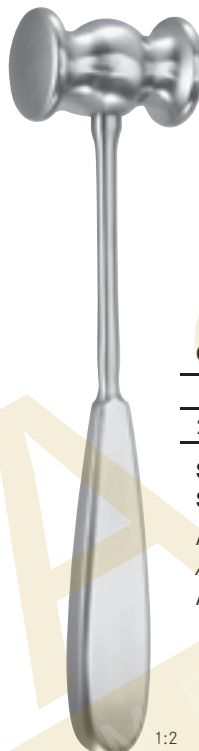
C O L L I N

	30 mm Ø - 220 g
200 mm - 8"	AI 24051-20

Stahl massiv
Steel solid
Acier solide
Acero solido
Acciaio massiccio

1:2

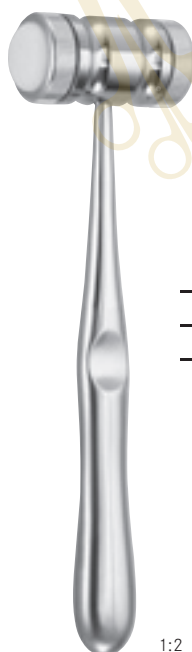
M E A D

	26 mm Ø - 320 g	26 mm Ø - 320 g
170 mm - 6¾"	AI 24050-17	AI 24050-90

Stahl massiv, mit Ferrozellbacken	Ersatzbacken, 1 Paar
Steel solid, with Ferrozell faces	Spare faces, 1 pair
Acier solide, avec plaques en Ferrozell	Plaques de rechange, 1 paire
<i>Acero solido, con placas en Ferrozell</i>	<i>Placas de cambio, 1 par</i>
Acciaio massiccio, con punte di Ferrozell	Placche di ricambio, 1 paia

1:2



Hämmer | Maillets
Mallets | *Martillos*
Martelli



1:2

PARTSCH

	22 mm Ø - 200 g
180 mm - 7"	AI 24053-18



1:2

	20 mm Ø - 140 g
165 mm - 6½"	AI 24055-16

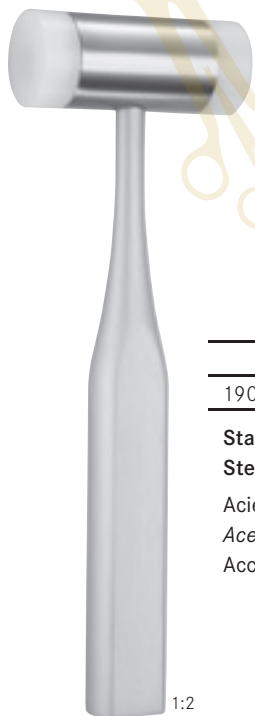

1:2

	25 mm Ø - 205 g
190 mm - 7½"	AI 24056-19

Stahl massiv, mit Kunststoffbacken
Steel solid, with plastic faces
Acier solide, avec plaques en plastic
Acero solido, con placas en plastica
Acciaio massiccio, con placche di plastica



1:2

LUCAE

	19 mm Ø - 230 g	25 mm Ø - 260 g
190 mm - 7½"	AI 24057-01	AI 24057-02

Stahl massiv
Steel solid
Acier solide
Acero solido
Acciaio massiccio



Meißel zur Nasenplastik
Chisels, osteotomes for rhinoplastic

Ostéotomes, ciseaux-burins pour rhinoplastique
Cinceles para rinoplastica
Scalpelli per plastica nasale



KILIAN

	5 mm
160 mm - 6¼"	AI24261-16



KILIAN-CLAUS

	5 mm
160 mm - 6¼"	AI24263-16

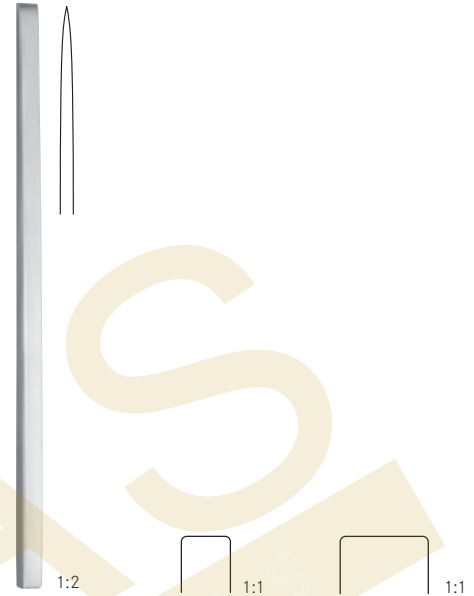

COTTLE

	7 mm	12 mm
150 mm - 6"	AI24270-07	AI24270-12

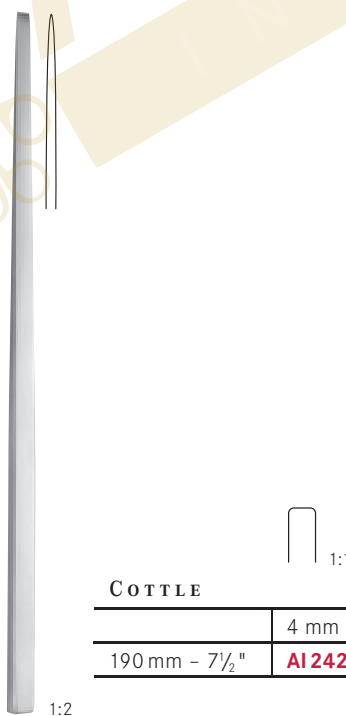

COTTLE

	4 mm
190 mm - 7½"	AI24272-19



COTTLE

	6 mm
180 mm - 7"	AI24277-06



Meißel zur Nasenplastik
Chisels, osteotomes for rhinoplastic

Ostéotomes, ciseaux-burins pour rhinoplastique
Cinceles para rinoplastica
Scalpelli per plastica nasale



COTTLE

	1:1	1:1	1:1	1:1
	4 mm	7 mm	9 mm	12 mm
180 mm - 7"	AI 24280-04	AI 24280-07	AI 24280-09	AI 24280-12



COTTLE

	1:1	1:1	1:1	1:1
	4 mm	7 mm	9 mm	12 mm
180 mm - 7"	AI 24281-04	AI 24281-07	AI 24281-09	AI 24281-12



Meißel zur Nasenplastik
Chisels, osteotomes for rhinoplastic

Ostéotomes, ciseaux-burins pour rhinoplastique
Cinceles para rinoplastica
Scalpelli per plastica nasale



FOMON

	4 mm	5 mm	6 mm	7 mm	8 mm
170 mm - 6 ³ / ₄ "	AI 24278-04	AI 24278-05	AI 24278-06	AI 24278-07	AI 24278-08

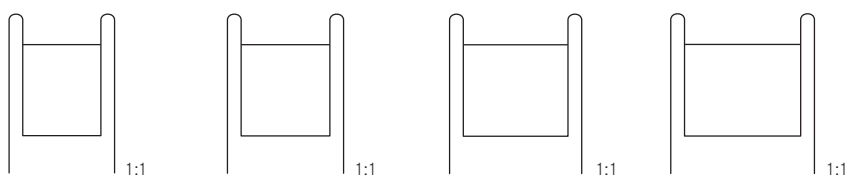

CINELLI

	10 mm	12 mm	14 mm	16 mm
180 mm - 7"	AI 24279-10	AI 24279-12	AI 24279-14	AI 24279-16



Meißel zur Nasenplastik
Chisels, osteotomes for rhinoplastic

Ostéotomes, ciseaux-burins pour rhinoplastique
Cinceles para rinoplastica
Scalpelli per plastica nasale

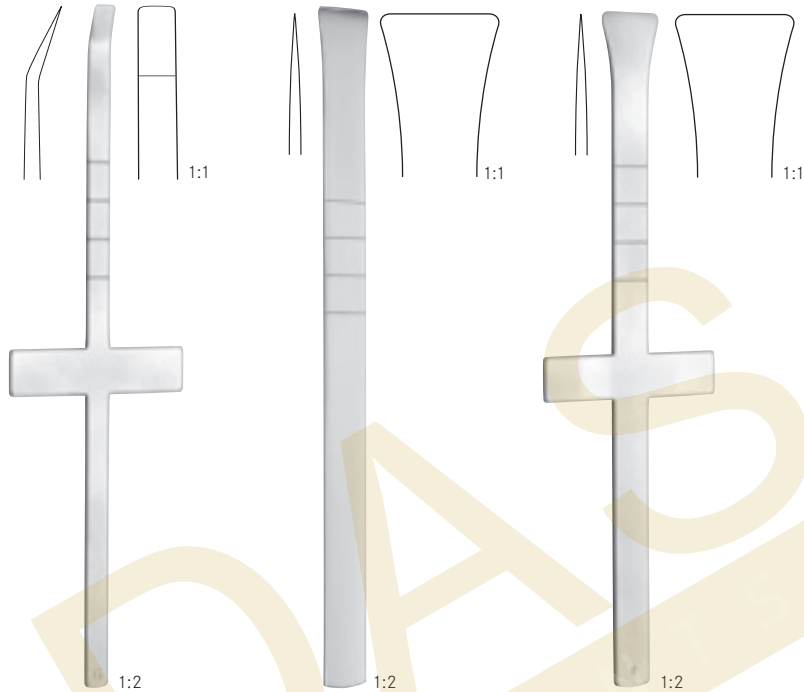

COTTLE

	6 mm	16 mm	16 mm
180 mm - 7"	AI 24283-06	AI 24284-16	AI 24286-16



1:1



COTTLE

	4 mm	7 mm	9 mm	12 mm
200 mm - 8"	AI 24287-04	AI 24287-07	AI 24287-09	AI 24287-12

1:2





Meißel zur Nasenplastik
Chisels, osteotomes for rhinoplastic

Ostéotomes, ciseaux-burins pour rhinoplastique
Cinceles para rinoplastica
Scalpelli per plastica nasale



1:2

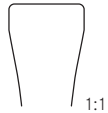

1:1

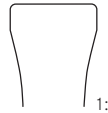

1:1



1:1

RUBIN

	10 mm	12 mm	14 mm
180 mm - 7"	AI 24290-10	AI 24290-12	AI 24290-14

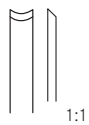

1:1

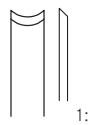

1:1

WALTER

	3 mm	4,5 mm
190 mm - 7½"	AI 24292-03	AI 24292-04



1:2



Meißel zur Nasenplastik
Chisels, osteotomes for rhinoplastic

Ostéotomes, ciseaux-burins pour rhinoplastique
Cinceles para rinoplastica
Scalpelli per plastica nasale



1:2

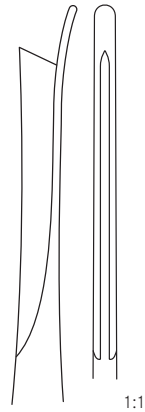

1:1

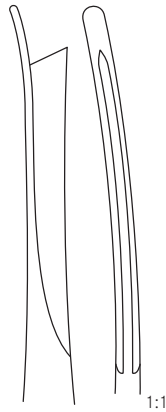

1:1

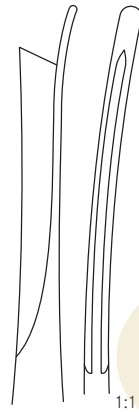

1:1

SILVER

180 mm - 7"	AI 24296-01	AI 24296-02	AI 24296-03
gerade straight droit <i>recta</i> rette	rechts right droite <i>derecha</i> destra	links left gauche <i>izquierda</i> sinistra	



1:1



1:1

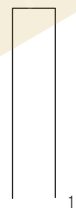

1:1



1:1

SHEEHAN

	2 mm	4 mm	6 mm	8 mm
160 mm - 6¼"	AI 24295-02	AI 24295-04	AI 24295-06	AI 24295-08



1:1



1:1



1:1

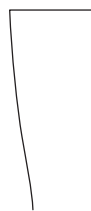

1:1

	10 mm	12 mm	15 mm	18 mm
160 mm - 6¼"	AI 24295-10	AI 24295-12	AI 24295-15	AI 24295-18



Meißel zur Nasenplastik
Chisels, osteotomes for rhinoplastic

Ostéotomes, ciseaux-burins pour rhinoplastique
Cinceles para rinoplastica
Scalpelli per plastica nasale

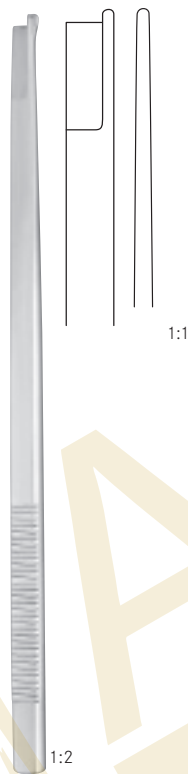

NEIVERT

200 mm - 8"

AI 24298-01

gerade
straight
droit
recta
rette

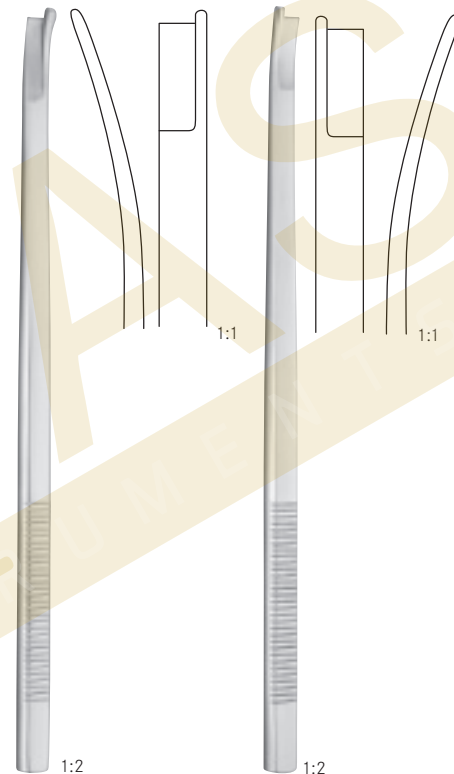

NEIVERT-
ANDERSON

200 mm - 8"

AI 24298-02

AI 24298-03

rechts
right
droite
derecha
destra

links
left
gauche
izquierda
sinistra



Septum-Elevatorien
Septum elevators

Elevateurs pour la cloison nasale
Elevadores para el tabique nasal
Elevatori per setto

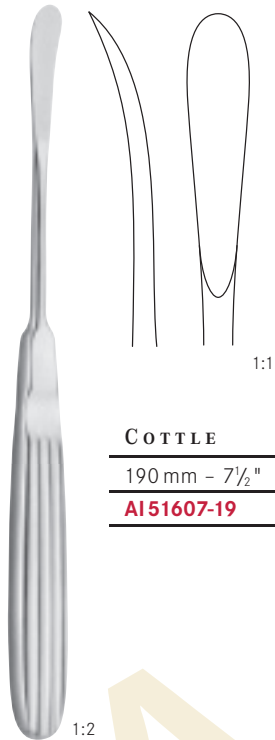

COTTLE

190 mm - 7½"

AI51607-19

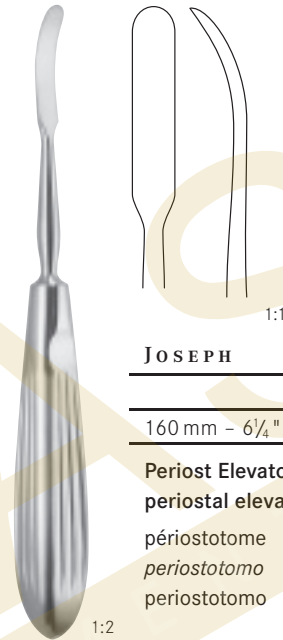

JOSEPH

160 mm - 6¼"

4 mm

AI51613-16

Periost Elevatorium
periosteal elevator
périostotome
periostotomo
periostotomo



HALLE

160 mm - 6¼"

AI51617-16



BALLENGER-HAJEK

190 mm - 7½"

AI51637-19

220 mm - 8¾"

AI51637-22





Septum-Elevatorien
Septum elevators

Elevateurs pour la cloison nasale
Elevadores para el tabique nasal
Elevatori per setto



FREER
190 mm - 7½"
AI 51625-19
stumpf
blunt
mousse
roma
smussa



FREER
180 mm - 7"
AI 51627-18
scharf/stumpf
sharp/blunt
tranchant/mousse
aguda/roma
acuta/smussa

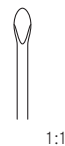

COTTLE
2.5 mm
160 mm - 6¼"
AI 51646-02

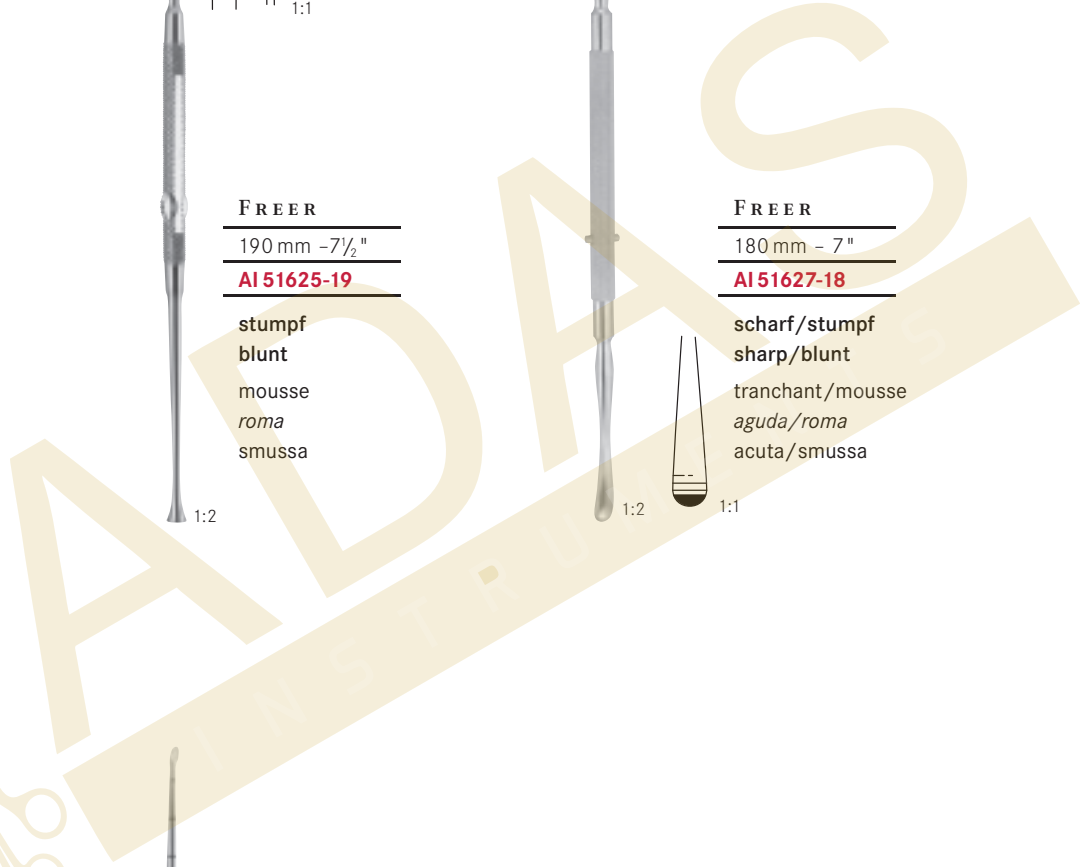



Septum-Elevatorien
Septum elevators

Elevateurs pour la cloison nasale
Elevadores para el tabique nasal
Elevatori per setto



200 mm - 8" **AI51645-20**

Saug-Raspatorium - biegsam, scharf
suction raspatory - malleable, sharp
rugine aspirante - flexible, tranchant
legra aspiradora - maleable y agudo
elevatore-aspiratore - flessibile, tagliente

COTTLE
210 mm - 8 1/4"
AI51644-21



Septum-Elevatoren
Septum elevators

Elevateurs pour la cloison nasale
Elevadores para el tabique nasal
Elevatori per setto

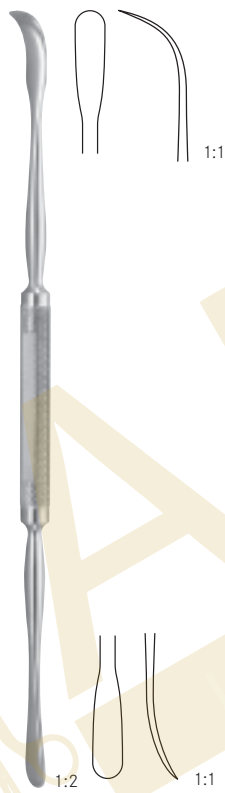

FREER

205 mm - 8"

AI 51631-20

scharf/stumpf
sharp/blunt

tranchant/mousse

aguda/roma

acuta/smussa



MASIG

200 mm - 8

AI 51636-21

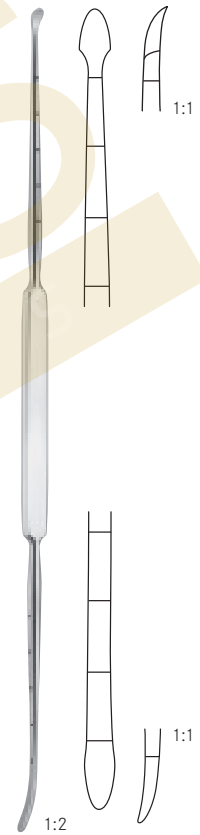

COTTLE

220 mm - 8³/₄"

AI 51643-22



Raspatorien und Ahlen für die Kieferchirurgie
Periosteal elevators and awls for maxillo-facial surgery

Rugines, décolleurs et passe-fils pour chirurgie maxillo-faciale
Periostótomos y leznas para maxillofacial
Raspatori, punteruoli per chirurgia massilofaciale



1:2

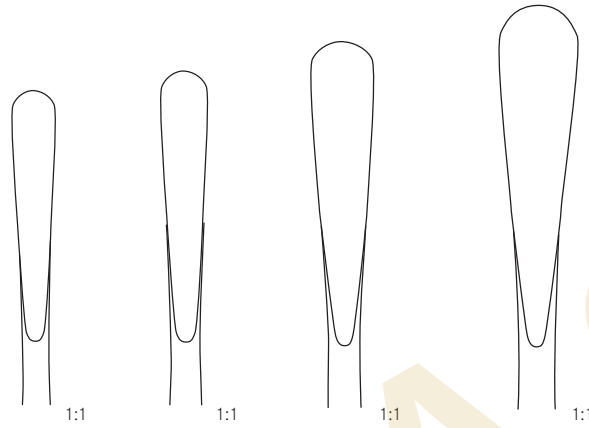

OBWEGESER

	6 mm	7 mm	9 mm	11 mm
175 mm - 7"	AI 52730-06	AI 52730-07	AI 52730-09	AI 52730-11



1:2

OBWEGESER

175 mm - 7"	AI 52735-01
-------------	--------------------



1:2

OBWEGESER

180 mm - 7"	AI 52749-18
-------------	--------------------



1:2

OBWEGESER

140 mm - 5½"	AI 52750-14
--------------	--------------------



1:2

OBWEGESER

230 mm - 8"	AI 52751-23
-------------	--------------------



Raspatorien - Elevatorien
Periosteal raspatories - Elevators

Rugines - Elevateurs
Raspatorios - Elevadores
Periostotomi - Elevatori

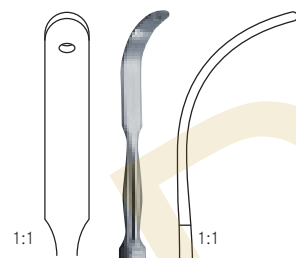

MC DONALD
190 mm - 7½ " AI 24519-19

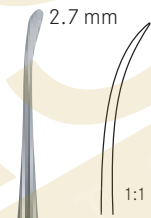
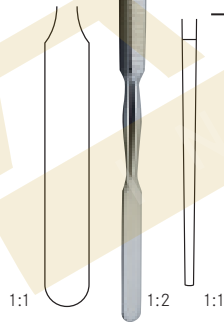

WATSON-CHEYNE
190 mm - 7½ " AI 24529-19

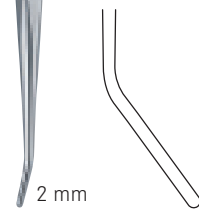



Meißel für die Kieferchirurgie
Osteotomes for maxillo-facial surgery

Ostéotomes pour chirurgie maxillo-faciale
Cinceles para maxilofacial
ScalPELLI per chirurgia massilofaciale



OBWEGESER

	7 mm	10 mm
215 mm - 8½"	AI 52755-21	AI 52756-21

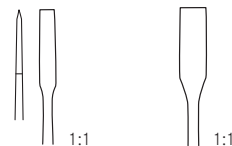

OBWEGESER

	2,5 mm	4 mm
150 mm - 6"	AI 52742-25	AI 52742-40



Raspatorien, Meißel für die Kieferchirurgie
Periosteal elevators, osteotomes for maxillo-facial surgery

Rugines, ostéotomes pour chirurgie maxillo-faciale
Periostótomos, cinceles para maxilofacial
Raspatori, scalpelli per chirurgia massilofaciale



OBWEGESER

	5 mm	8 mm	9 mm
200 mm - 8"	AI 52731-05	AI 52731-08	AI 52731-09

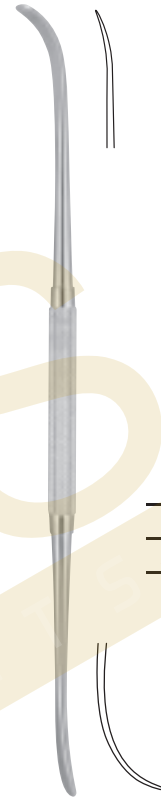

OBWEGESER

210 mm - 8 1/4"
AI 52738-21



OBWEGESER

210 mm - 8 1/4"
AI 52740-21



OBWEGESER

235 mm - 9 1/4"
x = 11 mm
AI 52744-24



OBWEGESER

185 mm - 7 1/4"
AI 52746-19



OBWEGESER

185 mm - 7 1/4"
AI 52747-19



Nasenspekula | Spéculums nasaux
Nasal specula | *Espéculos nasales*
Specoli nasali



1:2

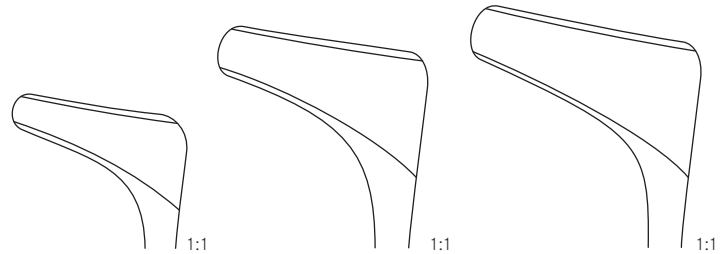

HARTMANN-HALLE

150 mm - 6"	AI 50813-01	AI 50813-02	AI 50813-03
-------------	--------------------	--------------------	--------------------

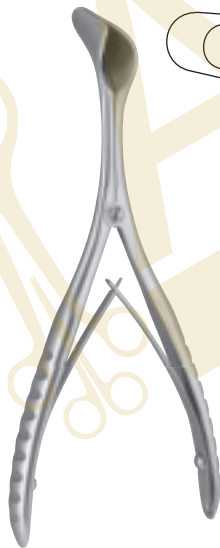

1:2

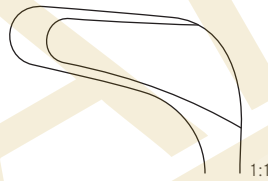

SCHWARZ

140 mm - 5½"

AI 50811-14



1:2

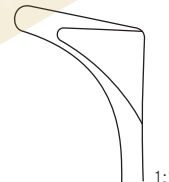

TIECK-HALLE

135 mm - 5¼"

AI 50823-13



Alle Nasenspekula sind optional auch mit Feststellschraube erhältlich
All nasal specula are also available with locking screw
Tous les spéculums nasaux sont aussi disponibles avec une vis de fixation
Todos los especulos nasales son también disponibles con un tornillo de fijación
Tutti gli specoli nasali sono disponibili anche con vite di fissaggio



Nasenspekula | Spéculums nasaux
Nasal specula | *Espéculos nasales*
Specoli nasali

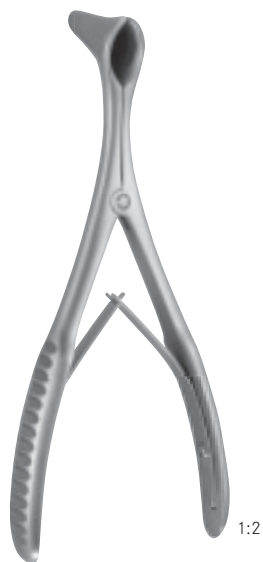

1:2

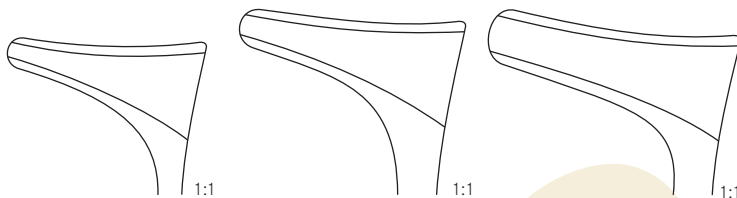

MODELL WIEN

145 mm - 5 3/4"	AI 50834-01	AI 50834-02	AI 50834-03
-----------------	--------------------	--------------------	--------------------



1:2

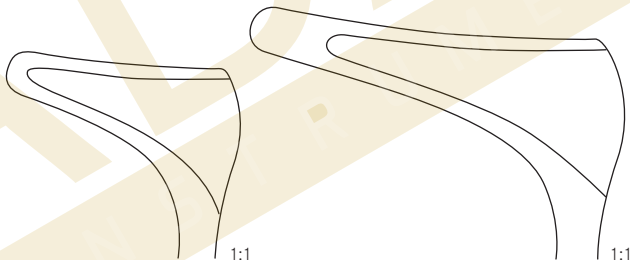

COTTLE

	x = 35 mm	x = 50 mm
150 mm - 6"	AI 50836-35	AI 50836-50

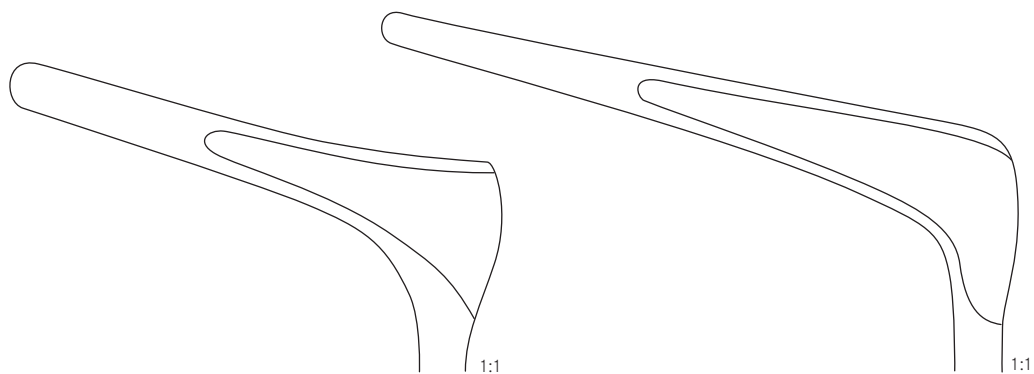

COTTLE

	x = 75 mm	x = 90 mm
150 mm - 6"	AI 50836-75	AI 50836-90



Nasenspekula | Spéculums nasaux
Nasal specula | *Espéculos nasales*
Specoli nasali

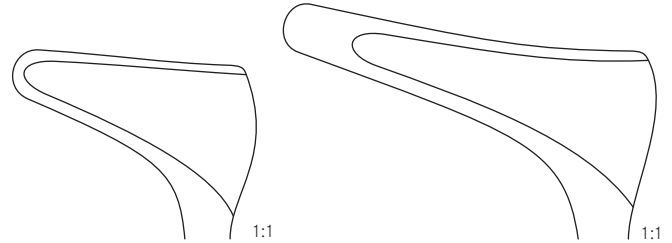

KILIAN

	x = 35 mm	x = 50 mm
130 mm - 5"	AI 50828-01	AI 50828-02

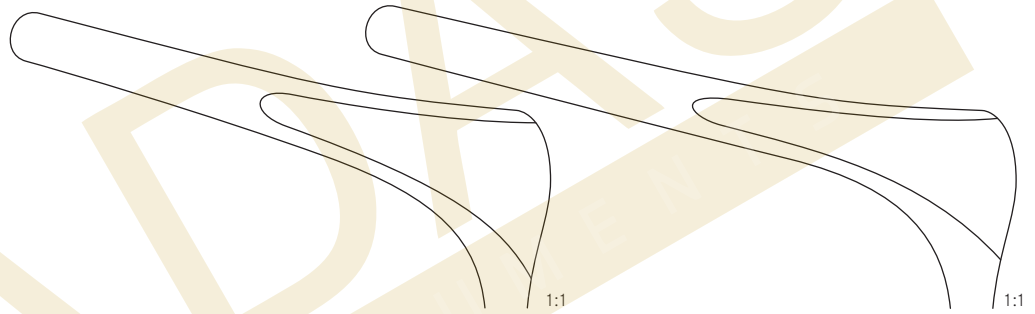

	x = 75 mm	x = 90 mm
130 mm - 5"	AI 50828-03	AI 50828-04

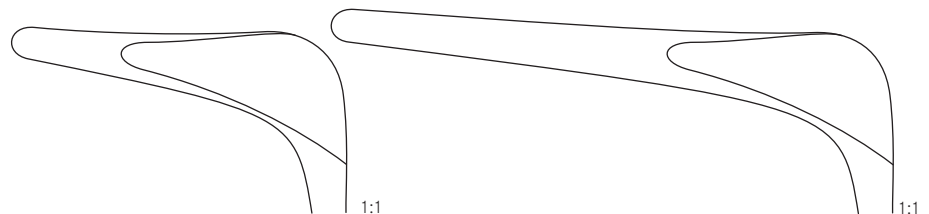
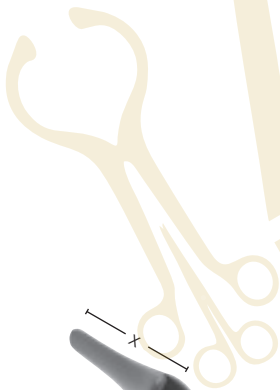

COTTLE

	x = 45 mm	x = 75 mm
140 mm - 5½"	AI 50840-45	AI 50840-75

schwarz verchromt
black, chrome plated
chromé en noir
chromado en negro
cromato nero



Nasensägen
Nasal saws

Scies nasales
Sierras nasales
Seghe nasali



JOSEPH

170 mm - 6 $\frac{3}{4}$ "

AI51655-20

AI51657-20



JOSEPH

190 mm - 7 $\frac{1}{2}$ "

AI51661-01

AI51661-02



Nasenraspeln | Râpes nasales
Nasal rasps | *Limas nasales*
Raspe nasali



AUFRICHT

210 mm - 8 1/4" **AI 51672-21**

auf Zug und auf Stoss schneidend
drawing and pushing cut
tranchant à traction et en poussant
cortante a tracción y empuje
tagliente a trazione e a urto

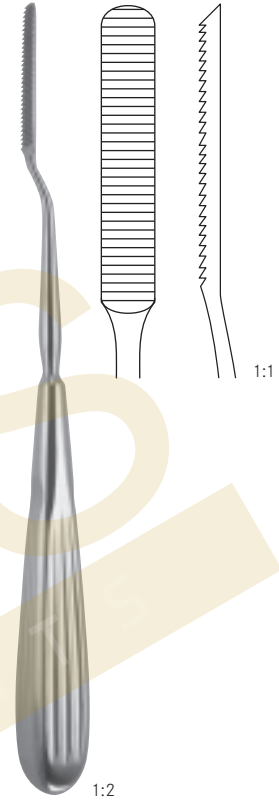

COTTLE

210 mm - 8 1/4" **AI 51665-21**

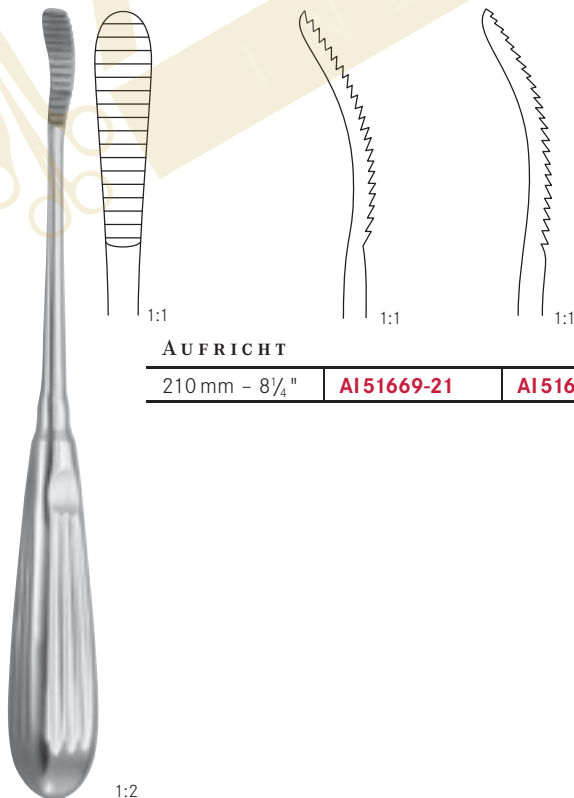

AUFRICHT

210 mm - 8 1/4" **AI 51669-21** | **AI 51671-21**





Nasenraspeln | Râpes nasales
Nasal rasps | *Limas nasales*
Raspe nasali

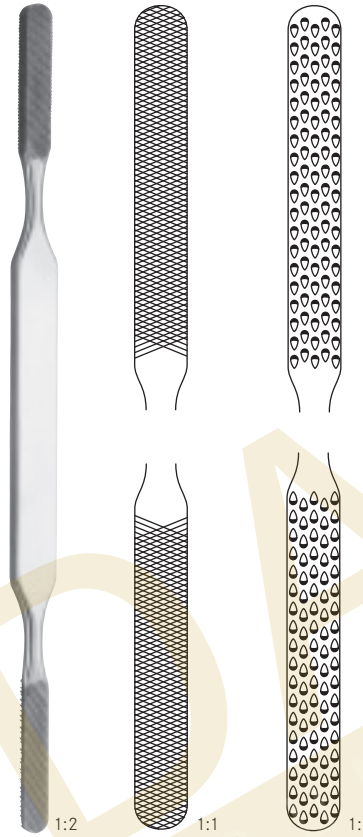

FOMON

210 mm - 8 1/4"

AI 51685-21

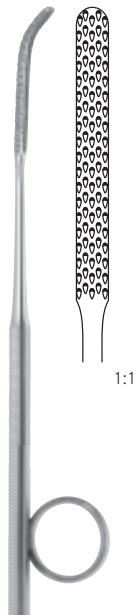

GALLAHER

160 mm - 6 1/4"

AI 51683-01

AI 51683-02

AI 51683-03



Raspeln mit Hartmetall
Rasps with tungsten carbide

Râpes avec inserts de carbure de tungstène
Limas con carburo de tungsteno
Raspe con tungsteno

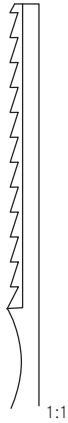

Fig. 1	Fig. 3	Fig. 5	Fig. 7	Fig. 9
12	16	24	36	52

Zähne
Teeth
Dentes
Dientes
Denti

FOMON TC

200mm - 8"	AI51686-01 tucar	AI 51686-03 tucar	AI51686-05 tucar	AI51686-07 tucar	AI 51686-09 tucar
------------	-------------------------	--------------------------	-------------------------	-------------------------	--------------------------

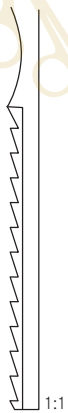

Fig. 2	Fig. 4	Fig. 6	Fig. 8	Fig. 10
14	20	30	44	62

Zähne
Teeth
Dentes
Dientes
Denti



Septumzangen
Septum forceps

Pinces pour la cloison nasale
Pinzas para el tabique nasal
Pinze per il setto nasale

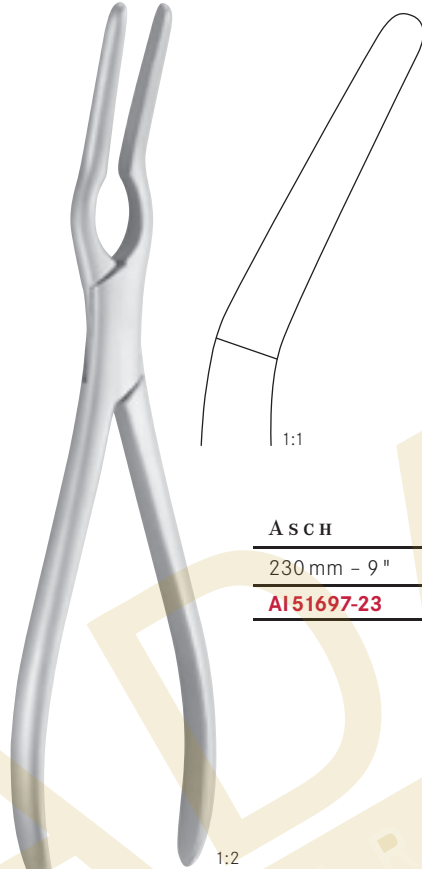

ASCH

230 mm - 9"

AI 51697-23



1:2

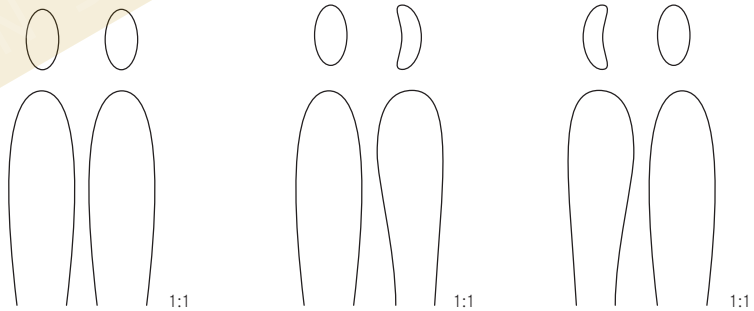

COTTLE-WALSHAM

230 mm - 9"

AI 51695-01

AI 51695-02

AI 51695-03

gerade
straight
droit
recta
rette

links
left
gauche
izquierda
a sinistra

rechts
right
droite
derecha
a destra



Septumzangen
Septum forceps

Pinces pour la cloison nasale
Pinzas para el tabique nasal
Pinze per il setto nasale



MIDDLETON-JANSEN
190 mm - 7½ " AI 51180-19

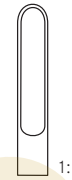
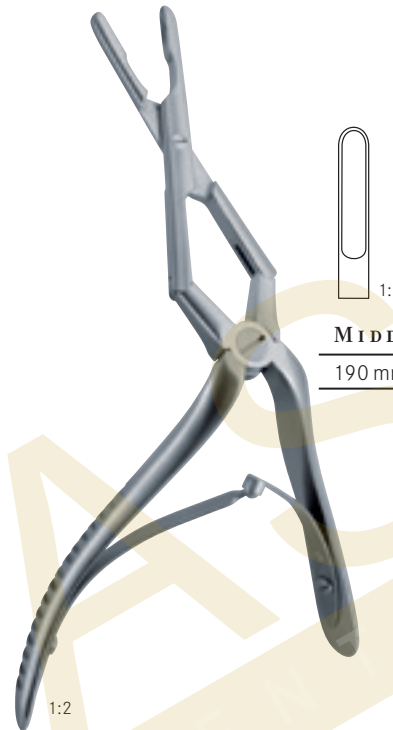

MIDDLETON-JANSEN
190 mm - 7½ " AI 51182-19

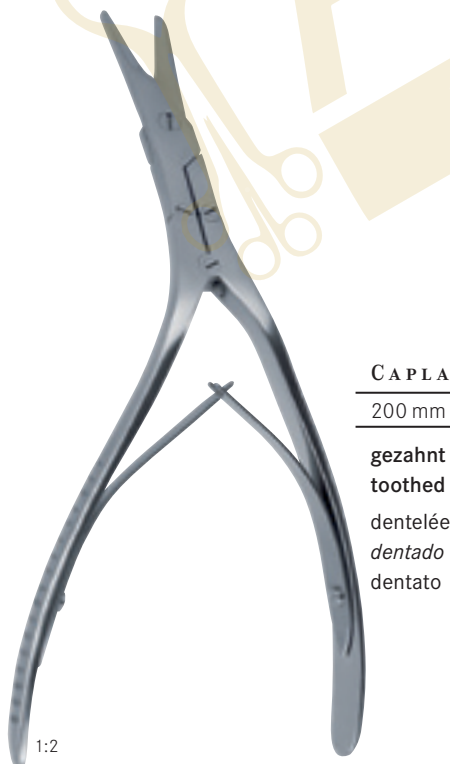

CAPLAN
200 mm - 8 " AI 51184-20

gezahnt
toothed
dentelée
dentado
dentato

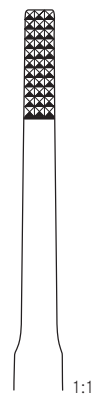

RUBIN
210 mm - 8¼ " AI 51188-21



AI 51188-01



Schutzkappe
Protection Cap

Capuchon protecteur
Caperuza protectora
Calotta protettiva



**Sehnenstripper
Tendon strippers**



 Instruments à écorcher les tendons
Enucleadores de tendones
 Scollatendini



	 1:1	 1:1	 1:1
	4.0 mm Ø	4.5 mm Ø	5.5 mm Ø
230 mm - 9"	AI 24578-40	AI 24578-45	AI 24578-55

Schaft biegsam
 Malleable shaft
 Tige malléable
 Tija maleable
 Asta malleabile

1:2



BUNNELL	 1:1	 1:1	 1:1
	Fig. 1	Fig. 2	Fig. 3
150 mm - 6"	AI 24575-01	AI 24575-02	AI 24575-03

 1:1	 1:1
Fig. 4	Fig. 5
AI 24575-04	AI 24575-05

1:2



Sehnenstripper
Tendon strippers

Instruments à écorcher les tendons
Enucleadores de tendones
Scollatendini



FISCHER

310 mm - 12 1/4"

AI 24580-31



BUNNELL

230 mm - 9"

AI 24582-23

Sehndurchzugssonde
Tendon passer

Sonde conductrice pour tendons
Sonda conductora de tendones
Sonda conduttrice per tendini



**KLEINERT-
KUTZ**

200 mm - 8"

20 mm Ø

AI 24588-20







Sehnenfazzangen
Tendon holding forceps

Pinces pour saisir les tendons
Pinzas para coger tendones
Pinze per afferrare tendini



BRAND	 1:1	 1:1	 1:1
	150 mm - 6"	190 mm - 7½"	240 mm - 9½"
	AI 24585-15	AI 24585-19	AI 24585-24

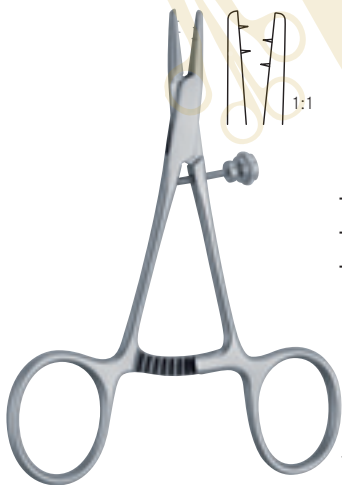

 1:1
130 mm - 5"
AI 38724-13

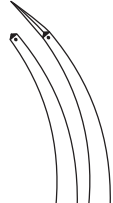

 1:1	 1:1
150 mm - 6"	AI 24589-15 AI 24590-15



Sehnenfasszangen
Tendon holding forceps

Pinces pour saisir les tendons
Pinzas para coger tendones
Pinze per afferrare tendini



205 mm - 8"

AI 24586-00

AI 24586-01

Sehnen durchzugszange
Tendon passer

Pince conductrice pour tendons
Pinza conductora para tendones
Pinza conduttrice per tendini



CAROLL

110 mm - 4¼"

AI 38723-11

Sehnenfaßzange
Tendon grasping forceps

Pince pour saisir les tendons
Pinza para coger tendones
Pinza per afferrare tendini



Hohlmeißelzangen | Pincés gougés
Bone rongeurs | *Pinzas gubias*
Pinze sgorbie

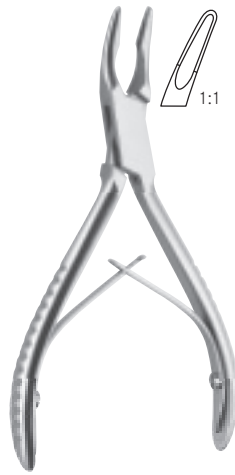

MINI-FRIEDMAN

120 mm - 4 3/4"

AI 24605-12



FRIEDMAN

140 mm - 5 1/2"

AI 24605-14

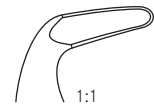
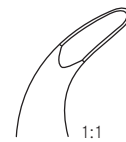

BLUMENTHAL

	Fig. 1	Fig. 2	Fig. 3
155 mm - 6"	AI 24606-01	AI 24606-02	AI 24606-03



Hohlmeißelzangen
Bone rongeurs

Pincès gougés
Pinzas gubias
Pinze sgorbie



BÖHLER		
150 mm - 6"	AI 24613-00	AI 24613-02



STELLBRINK		
175 mm - 7"	AI 24614-01	AI 24614-02

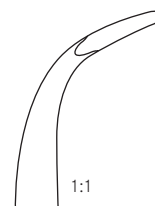

leicht gebogen
slightly curved
légèrement courbe
ligeramente curvada
legermente curvata

stark gebogen
strongly curved
très courbe
fuertemente curvada
fortemente curvata





Hohlmeißelzangen
Bone rongeurs

Pinces gouges
Pinzas gubias
Pinze sgorbie



**ZAUFAL-
JANSEN**

180 mm - 7"

AI24614-18

1:2

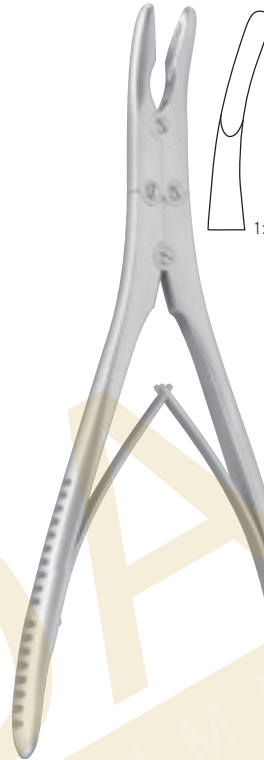

MARQUARDT

200 mm - 8"

AI24614-20

1:2



BEYER

180 mm - 7"

AI24615-18

1:2



1:1



1:1

RUSKIN

180 mm - 7"

AI24616-05

AI24616-04

1:2



Knochensplitterzangen | Pincés coupantes à os
Bone cutting forceps | *Pinzas cortantes para huesos*
 Cesioie per ossa

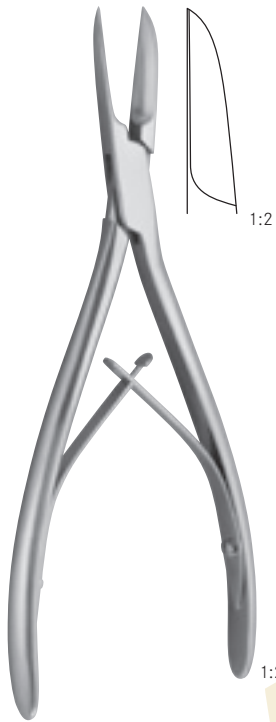

**COTTLE-
KAZANJIAN**
190 mm - 7½"
AI24649-19

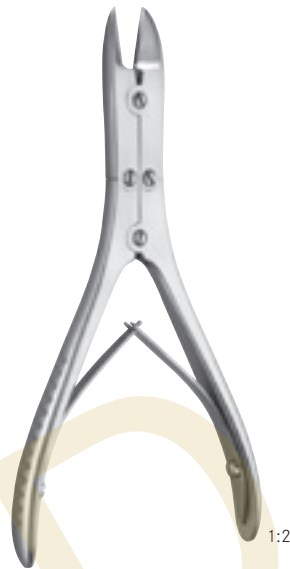

BÖHLER

150 mm - 6"



1:1

AI24654-15



1:1

AI24655-15



RUSKIN-LISTON

185 mm - 7¼"

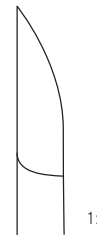

1:1

AI24660-18



1:1

AI24661-18



Tränenkanal-Dilatatoren
 Lacrimal dilators

 Dilatateurs pour le canal lacrymal
Dilatadores para el canal lacrimal
 Dilatatori lacrimali

Tränenkanal-Dilatator

Lacrimal dilators

Dilatateurs pour le canal lacrymal

Dilatadores para el canal lacrimal

Dilatatori lacrimali

BOWMAN

Fig. 000/ 00	Fig. 00/ 0	Fig. 0/ 1	Fig. 1/ 2	Fig. 2/ 3
0.4 / 0.6 mm Ø	0.7 / 0.8 mm Ø	0.8 / 0.9 mm Ø	0.9 / 1.1 mm Ø	1.1 / 1.3 mm Ø
AI 40099-00	AI 40100-00	AI 40100-01	AI 40100-12	AI 40100-23
Fig. 3/ 4	Fig. 4/ 5	Fig. 5/ 6	Fig. 6/ 7	Fig. 7/ 8
1.3 / 1.4 mm Ø	1.4 / 1.5 mm Ø	1.5 / 1.6 mm Ø	1.6 / 1.8 mm Ø	1.8 / 1.9 mm Ø
AI 40100-34	AI 40100-45	AI 40100-56	AI 40100-67	AI 40100-78

 zylindrisch
 cylindrical
 cylindriques
cilíndrico
 cilindrico

WILLIAMS

Fig. 000/ 00	Fig. 00/ 0	Fig. 0/ 1	Fig. 1/ 2	Fig. 2/ 3
0.4 / 0.6 mm Ø	0.7 / 0.8 mm Ø	0.8 / 0.9 mm Ø	0.9 / 1.1 mm Ø	1.1 / 1.3 mm Ø
AI 40101-00	AI 40102-00	AI 40102-01	AI 40102-12	AI 40102-23
Fig. 3/ 4	Fig. 4/ 5	Fig. 5/ 6	Fig. 6/ 7	Fig. 7/ 8
1.3 / 1.4 mm Ø	1.4 / 1.5 mm Ø	1.5 / 1.6 mm Ø	1.6 / 1.8 mm Ø	1.8 / 1.9 mm Ø
AI 40102-34	AI 40102-45	AI 40102-56	AI 40102-67	AI 40102-78

geknöpft

probe

boutonnés

botonado

botonuti



Tränenkanal-Dilatatoren
Lacrimal dilators

Dilatateurs pour le canal lacrymal
Dilatadores para el canal lacrimal
Dilatatori lacrimali



115 mm - 4½"	AI 18110-11	AI 18112-11
130 mm - 5"	AI 18110-13	AI 18112-13
145 mm - 5¾"	AI 18110-14	AI 18112-14
160 mm - 6¼"	AI 18110-16	AI 18112-16
180 mm - 7"	AI 18110-18	AI 18112-18
200 mm - 8"	AI 18110-20	AI 18112-20

WILDER

AI 40105-00	AI 40106-00	AI 40107-00
--------------------	--------------------	--------------------

Tränenkanal-Dilatatoren
Lacrimal dilators

Dilatateurs pour le canal lacrymal
Dilatadores para el canal lacrimal
Dilatatori lacrimali



**Knorpelquetscher
Bone crusher**

Broyeurs pour os
Prensas para huesos
Trittatori osseo



1:2



1:2

COTTLE

AI51648-00

**Quetscher mit Klammer
bone crusher with clamp**

broyeur avec pince
prensa para huesos
sciaccia cartilagine



1:2

AI51755-00

**Knorpelhalter
cartilage holding forceps**

pince à saisir des cartilages
pinza para tener cartilagos
pinza fissa cartilagine



COTTLE

AI51649-00

**Knochenmühle
bone mill**

moulin d'os
molino de huesos
mulino per ossa



Instrumenten-Kassetten aus Edelstahl
Instrument trays made of stainless steel

Contenaires d'instruments en acier inox
Cajas en acero inox para instrumental
Scatole per sterilizzazione di acciaio inossidabile



Mit Deckel- und Bodenlochung mit Textil-Langzeitfiltern für Dampfsterilisation
With lid and bottom perforation with textil "Longterm" filters for steam sterilisation
Couvercle et boîtier perforé avec filtre en textile pour stérilisation à vapeur
Con perforación en tapa y fondo, con filtros en tejido para esterilización a vapor
Con filtri tessili, per la sterilizzazione a vapore

Silikon-Andrückleisten zum Fixieren der Instrumente
Silicone protective strips for fixation of instruments

Tapis en silicone pour fixer les instruments
Tiras de silicon para fijar los instrumentos
Righe di silicone per fissare gli strumenti

Silikon-Noppenstreifen zur schonenden Auflage der Instrumente
Silicon strips for a soft and protective storage of the instruments

Tapis en silicone pour la protection des instruments
Mata de silicon para proteger los instrumentos
Stuoie di silicone per proteggere gli strumenti

1 herausnehmbare Siebplatte
1 removable tray insert

1 tableau pour sortir
1 placa para sacar
1 cestello

Kennzeichnungsschilder nach Wahl (Farbe und Text)
Marking plate for selection: colour and description

Plaque d'identification (texte et couleur selon demande)
Placas de identificación a opción (color y texto)
Placche d'identificazione (colore a scelta)

280 x 195 x 55 mm	265 x 255 x 55 mm	380 x 260 x 55 mm	200 x 140 x 55 mm	470 x 250 x 55 mm
AI 85100-01	AI 85101-01	AI 85102-01	AI 85103-01	AI 85104-01

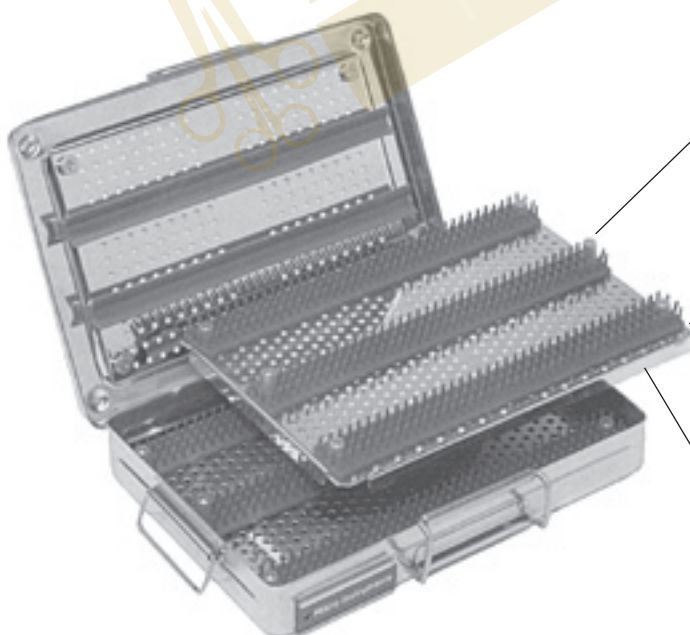

wärmeisolierende Halteknöpfe zum Herausheben
heatisolated handles

pins isolés pour sortir des tableaux
Pernos aislados para sacar las placas
maniglia a forma di botone

2 herausnehmbare Siebplatten
2 removable tray inserts

2 tableaux detachables
2 placas para sacar
2 cestelli

Silikon-Andrückleisten an der Unterseite des Siebes
Silicon protective strips at the lower side of the tray

Tapis de silicone à la partie inférieure des tableaux
Tiras de silicon a bajo de las placas
Righe di silicone

280 x 195 x 65 mm	265 x 255 x 65 mm	380 x 260 x 65 mm	200 x 140 x 65 mm	470 x 250 x 65 mm
AI 85100-03	AI 85101-03	AI 85102-03	AI 85103-03	AI 85104-03



Grundinstrumentarium für die plastische Chirurgie | **Set de base pour la chirurgie plastique**
Basic set for plastic surgery | *Juego de base para la cirugía plástica*
Set di base per la chirurgia plastica

AI 56500-00













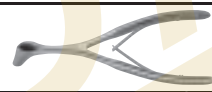

Dieser Satz beinhaltet folgende Instrumente:

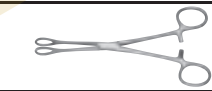
This set contents the following instruments:

Ce jeu contient des instruments suivants:

Este juego contiene los instrumentos siguientes:















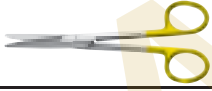
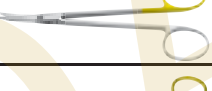

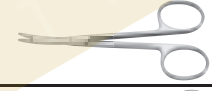
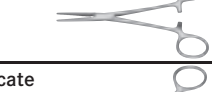
Questo set contiene seguenti strumenti:

FARABEUF [pos 01]	Retractor set		120 mm	AI 17311-12	
DESMARRES [pos 02]	Retractor		160 mm	AI 17038-10	S 90
JOSEPH [pos 03]	Retractor		150 mm	AI 16900-15	S 85
JOSEPH [pos 04]	Retractor		160 mm	AI 16910-02	S 85
[pos 05]	Retractor, 4 teeth, sharp, flexible		160 mm	AI 17024-16	S 90
HARTMANN - HALLE [pos 06]	Nasal specula, fig. 1		150 mm	AI 50813-01	S 140
HARTMANN - HALLE [pos 07]	Nasal specula, fig. 2		150 mm	AI 50813-02	S 140
HARTMANN - HALLE [pos 08]	Nasal specula, fig. 3		150 mm	AI 50813-03	S 140
FOERSTER [pos 09]	Sponge holding forceps, curved		180 mm	AI 15185-18	S 83
JOSEPH [pos 10]	Periosteal elevator, 4 mm		160 mm	AI 51613-16	S 132
FREER [pos 11]	Elevators, sharp / blunt		180 mm	AI 51627-18	S 133
CASTROVIEJO - JACOBSON [pos 12]	Needle holder, straight		180 mm	AI 20710-18	S 114
BARRAQUER [pos 13]	Needle holder, curved		145 mm	AI 20201-14	S 114
WEBSTER [pos 14]	Needle holder, smooth, TC		130 mm	AI 20509-13	S 106
DERF [pos 15]	Needle holder, TC		125 mm	AI 20508-12	S 105
MAYO - HEGAR [pos 16]	Needle holder, TC		180 mm	AI 20512-18	S 108
[pos 17]	Standard dressing forceps		145 mm	AI 10000-14	



Grundinstrumentarium für die plastische Chirurgie
Basic set for plastic surgery

Set de base pour la chirurgie plastique
Juego de base para la cirugía plastica
Set di base per la chirurgia plastica

ADSON [pos 18]	Dressing forceps		120 mm	AI 10500-12	S 54
TAYLOR [pos 19]	Dressing forceps, bayonet		175 mm	AI 10313-17	S 59
ADSON [pos 20]	Tissue forceps, 1 x 2 teeth		120 mm	AI 11200-12	S 55
ADSON - BROWN [pos 21]	Tissue forceps		120 mm	AI 11210-12	S 54
GRAEFE [pos 22]	Forceps, fine pattern, straight, 1 x 2 teeth		105 mm	AI 11730-10	S 56
MAYO [pos 23]	Scissors, straight		150 mm	AI 8272-15	S 24
SHEA [pos 24]	Scissors, curved, pointed		120 mm	AI 9209-12	S 45
METZENBAUM - NELSON [pos 25]	Scissors, straight, fig. 1		180 mm	AI 8347-18	S 28
SHEA [pos 26]	Scissors, straight, pointed		120 mm	AI 9208-12	S 45
METZENBAUM - FINO [pos 27]	Scissors, curved, fig. 1		180 mm	AI 8371-18	S 30
KNAPP [pos 28]	Fine scissors, blunt, curved		105 mm	AI 8689-10	S 32
CRILE [pos 29]	Haemostatic forceps, curved, 1 x 2 teeth		140 mm	AI 12053-14	S 78
KOCHER [pos 30]	Haemostatic forceps, curved, 1 x 2 teeth, delicate		160 mm	AI 12079-16	S 80
CRILE [pos 31]	Haemostatic forceps, curved		140 mm	AI 12051-14	S 78
HALSTEAD - MOSQUITO [pos 32]	Haemostatic forceps, curved		125 mm	AI 12011-12	S 76
ALLIS [pos 33]	Intestinal grasping forceps, 4 x 5 teeth		150 mm	AI 28140-15	S 71
YANKAUER [pos 34]	Suction tube		270 mm	AI 6350-27	
[pos 35]	Scalpel handle, no. 3		??? mm	AI 7110-03	S 7
BACKHAUS [pos 36]	Towel forceps		110 mm	AI 12805-11	
BACKHAUS [pos 37]	Towel forceps		130 mm	AI 12805-13	



**Inhaltsverzeichnis
Index**
**Tables de matières
Indice
Indice**

ADLERKREUTZ Pinzetten.....	57	CONVERSE Schere.....	34
ADSON Arterienklemmen.....	80	CORONAL LIFT Wundhaken.....	98
ADSON Pinzetten.....	54, 55	COTTLE Elevatorien.....	132-135
ADSON-BROWN Pinzetten.....	54	COTTLE Knorpelquetscher.....	160
ADSON-GRAEFE Pinzette.....	54	COTTLE Meißel.....	125, 126, 128
ALLIS Gewebefasszangen.....	82	COTTLE Nasenraspel.....	144
ALLIS Gewebefasszangen PRIMUS .INE.....	71	COTTLE Nasenspekula.....	141-142
ALLIS-ADAIR Gewebefasszange.....	82	COTTLE Trachealhäkchen.....	84, 85, 87, 88
ALLIS-BABY Gewebefasszange.....	82	COTTLE-KAZANJIAN Knochensplitterzange.....	157
ALM Wundsperrerr.....	95	COTTLE-NEIVERT Nasenhäkchen.....	88
Anatomische Pinzetten - Chirurgische Pinzetten.....	52-59	COTTLE-WALSHAM Septumzangen.....	148
Anlegepinzetten für Gefäßclips.....	68	CRILE Arterienklemmen.....	78
Approximatoren, Gefäßclips.....	69	CRILE Arterienklemmen PRIMUS .INE.....	73
Approximatoren, Gefäßclips nach Biemer.....	67	CRILE Nasenhaken.....	85
Arterienklemmen.....	71-81	CRILE-MURRAY Nadelhalter.....	105
Arterienklemmen PRIMUS .INE.....	71-75	CRILE-RANKIN Arterienklemmen.....	78
ASCH Septumzange.....	148	CRILE-RANKIN Arterienklemmen PRIMUS .INE.....	73
Atraumatische Pinzetten.....	60-62	CRILE-WOOD Nadelhalter.....	105
AUFRICHT Nasenhaken.....	86	CUSHING anatomische Pinzetten.....	52
AUFRICHT Nasenraspeln.....	144	DANDY Arterienklemmen.....	77
AUFRICHT Scheren.....	40	DAVIS Face-Lift-Scheren.....	42
Augenscheren.....	45-47	DE BAKEY atraumatische Pinzetten.....	61, 62
BABCOCK Gewebefasszangen PRIMUS .INE.....	71	DE BAKEY BAYONET atraumatische Pinzetten.....	60
BABY-ADSON Arterienklemmen.....	81	DE Bakey Nadelhalter.....	111
BABY-CRILE-WOOD Nadelhalter.....	106	DE BAKEY-GERALD atraumatische Pinzetten.....	60
BABY-METZENBAUM Scheren PRIMUS .INE.....	17	DERF Nadelhalter.....	105
BABY-MIXTER Arterienklemmen.....	81	Dermatome.....	9-10
BALLENGER-HAJEK Septumelevatorien.....	132	DESMARRES Lidhalter.....	90
BARRAQUER Mikronadelhalter.....	117	DIETHRICH Nadelhalter.....	113
BARRAQUER Nadelhalter.....	114	DUEHRSSSEN anatomische Pinzette.....	57
BARRON Skalpellgriff.....	7	Face-Lift-Scheren.....	42-43
BELUCCI Wundsperrerr.....	103	Feine Scheren.....	32-34
BEUSE Scheren.....	34	FERREIRA Brust Dissektoren.....	92
BEYER Hohlmeißelzange.....	156	FERREIRA Wundhaken.....	99
BIEMER Approximatoren, Gefäßclips.....	67	FISCHER Sehnenstripper.....	151
Bleihände.....	12	FOERSTER (BALLENGER) Schwammzangen.....	83
BLUMENTHAL Hohlmeißelzangen.....	154	FOMON Meißel.....	127
BOETTCHER Nasenschere.....	44	FOMON Nasenhäkchen.....	84, 88
BÖHLER Hohlmeißelzangen.....	155	FOMON Nasenraspeln.....	145-146
BÖHLER Knochensplitterzangen.....	157	FOMON Nasenscheren.....	44
BONN Augenscheren.....	45	FOSTER-GILLIES Nadelhalter.....	109
BOWMAN Tränenkanal-Dilatatoren.....	158	FREEMAN Mamillenringe.....	11
BRAND Sehnenfasszangen.....	152	FREEMAN Wundhaken.....	96-97, 99
BROPHY (SULLIVAN) Scheren.....	27	FREEMAN-KAYE Scheren.....	40
BROPHY Chirurgische Pinzetten.....	58	FREER Elevatorien.....	133, 135
Brust Dissektoren.....	91-93	FRIEDMAN Hohlmeißelzange.....	154
BUNELL Sehnenstripper.....	150, 151	GALLAHER Nasenraspeln.....	145
CAPLAN Septumzange.....	149	Gefäßdilatatoren.....	66
CAROLL Sehnenfasszange.....	153	GERALD anatomische Pinzetten.....	59
CASTANARES Face-Lift-Scheren.....	43	Gewebe- und Darmfasszangen.....	82
CASTROVIEJO Mikronadelhalter.....	115	Gewebe- und Darmfasszangen PRIMUS .INE.....	71
CASTROVIEJO Mikroscheren.....	50	GILLIES chirurgische Pinzette.....	53
CASTROVIEJO-JACOBSON Nadelhalter.....	114	GILLIES Nadelhalter.....	109
CHANG Mamillenring.....	11	GILLIES Nasenhäkchen.....	84
Chirurgische Pinzetten - Anatomische Pinzetten.....	52-59	GOLDMAN-FOX Scheren.....	41
Chirurgische Scheren.....	24-27	GORNEY PLATYSMA Scheren.....	38
Chirurgische Scheren - Präparierscheren.....	28-30	GORNEY Scheren.....	37
CINELLI Meißel.....	127	GORNEY Wundhaken.....	96
COLLIN Hammer.....	123	GORNEY-DELICATE Scheren.....	39
CONVERSE Nasenhaken.....	86	GORNEY-FREEMAN Scheren.....	38



Inhaltsverzeichnis
Index

Tables de matières
Indice
Indice

GRADLE Schere.....	32
GRAEFE Pinzetten.....	56
GREENBERG PAR Scheren.....	46
GREGORY Schere.....	43
GROSSMAN Mamillenring.....	11
HAJEK Hammer.....	123
HALLE Elevatorium.....	132
HALSEY Nadelhalter.....	107
HALSTED-MOSQUITO Arterienklemmen.....	76
HALSTED-MOSQUITO Arterienklemmen PRIMUSINE	72
Hämmer.....	123-124
HARTMANN Arterienklemmen.....	76
HARTMANN Arterienklemmen PRIMUSINE	72
HARTMANN-HALLE Nasenspekula.....	140
HEANEY Nadelhalter.....	110
HEGAR-BAUMGARTNER Nadelhalter.....	106
Hohlmeißelzangen.....	154-156
Hohlsonden.....	159
HOLTZHEIMER Wundsperrerr.....	95
HUMBY Dermatom.....	10
Instrumenten-Kassetten aus Edelstahl.....	161
Irisscheren.....	31
ITERSON Trachealhäkchen.....	88
JACKSON Trachealhäkchen.....	89
JACOBSON Mikronadelhalter.....	116
JOSEPH Elevatorium.....	132
JOSEPH Nasenhäkchen.....	85
JOSEPH Nasensägen.....	143
JOSEPH Scheren.....	37
JOSEPH Scheren PRIMUSINE	20
KAHN Scheren.....	41
KAYE BLEPHAROPLASTY Scheren.....	47
KAYE RIBBON TYPE Scheren.....	47
KAYE Scheren.....	39
KELLY Arterienklemmen.....	79
KELLY Arterienklemmen PRIMUSINE	73
KELLY Scheren.....	26
KELLY Scheren PRIMUSLINE	20
KELLY-RANKIN Arterienklemmen.....	79
KELLY-RANKIN Arterienklemmen PRIMUSINE	73
KILIAN Meißel.....	125
KILIAN Nasenspekula.....	142
KILIAN-CALUS Meißel.....	125
KILNER (RAGNELL) Scheren.....	36
KILNER Nadelhalter.....	110
KILNER Nasenhäkchen.....	84, 87
KLEINERT-KURTZ Sehnenstripper.....	151
KNAPP (ROLLET) Trachealhäkchen.....	90
KNAPP Scheren.....	32
KNIGHT Nasenschere.....	44
Knochensplitterzangen.....	157
Knorpelquetscher.....	160
KOCHER Arterienklemmen.....	80
KOCHER Arterienklemmen PRIMUSINE	74
KOCHER-FINO Arterienklemmen PRIMUSINE	75
LANGE Trachealhäkchen.....	84
LERICHE Arterienklemmen.....	79
LEXER Scheren.....	26
LEXER Scheren PRIMUSLINE	18
LICHTENBERG Nadelhalter.....	113

LOCKLIN Scheren.....	33
LOCKWOOD Gewebefasszange.....	82
LUCAE Hämmer.....	124
LUKENS Trachealhäkchen.....	89
MACCOLLUM-DINGMAN Brust Dissektor.....	92
Mamillenringe.....	11
MARQUARDT Hohlmeißelzange.....	156
MARTINEZ-KILNER Nasenhäkchen.....	87
MASING Elevatorium.....	135
MATHIEU-OLSEN Nadelhalter.....	106
MAYO Scheren.....	24
MAYO-HEGAR Nadelhalter.....	108
MAYO-LEXER Scheren PRIMUSINE	18
MAYO-STILLE Scheren PRIMUSINE	19
MC DONALD Raspatorium.....	137
MC INDOE anatomische Pinzetten.....	53
MC INDOE Scheren.....	33
MEAD Hämmer.....	123
Meißel für die Kieferchirurgie.....	138
Meißel zur Nasenplastik.....	125-131
Messinstrumente.....	11
METZENBAUM Scheren PRIMUSINE	16
METZENBAUM-FINO Scheren.....	30
METZENBAUM-FINO Scheren PRIMUSINE	17
METZENBAUM-NELSON Scheren.....	28-29
MEYERDING Wundhaken.....	95
MICRO-ADSON Pinzetten.....	54-55
MICRO-MOSQUITO Arterienklemmen.....	76
MICRO-MOSQUITO Arterienklemmen PRIMUSINE	72
MIDDLETON-JANSEN Septumzangen.....	149
Mikroklingen Halter - Mikroklingen.....	6
Mikronadelhalter.....	115-122
Mikronadelhalter mit Rundgriff.....	117-119
Mikro-Pinzetten.....	63-65
Mikro-Scheren.....	48-50
MILIGAN Wundsperrerr.....	103
MINI-FRIEDMAN Hohlmeißelzangen.....	154
MINI-RYDER Nadelhalter.....	113
MODELL WIEN Nasenspekula.....	141
MOSQUITO-DANDY Arterienklemme.....	77
Nadelhalter.....	105-122
Nadelhalter, Mikro.....	115-122
Nadelhalter, Titan.....	121-122
Nasen- und Trachealhäkchen.....	84-88
Nasenraspeln.....	144-146
Nasenraspeln mit Hartmetall.....	146
Nasensägen.....	143
Nasenscheren.....	44
Nasenspekula.....	140-142
NEIVERT Meißel.....	131
NEIVERT Nadelhalter.....	110
NEIVERT Trachealhäkchen.....	88
NEIVERT-ANDERSON Meißel.....	131
NEUMANN Schere.....	33
OBWEGESER Raspatorien.....	136, 139
OBWEGESER Wundhaken.....	100-101
OEHLEH chirurgische Pinzetten.....	53
OLSEN-HEGAR Nadelhalter.....	107
PARTSCH Hammer.....	124
PAR-TYPE Scheren.....	46



**Inhaltsverzeichnis
Index**
**Tables de matières
Indice
Indice**

PÉAN Arterienklemmen	78	Trachealhäkchen	89-90
PÉAN Arterienklemmen PRIMUS .INE	74	Tränenkanal-Dilatatoren.....	158-159
PÉAN-FINO Arterienklemmen PRIMUS .INE	75	TRAVERS Wundsperrer.....	103
PECK-JOSEF Scheren.....	27	Tupfer- und Schwammzangen.....	83
PIERSE Mikro-Pinzetten.....	65	TYP JUWELIER Mikro-Pinzetten.....	64
Pinzetten	52-65	ULTRA-MICRO-ADSON (BRAKA) Pinzette.....	55
Pinzetten, atraumatische.....	60-62	VANNAS Mikro-Scheren.....	50
Pinzetten, Mikro-.....	63-65	VASCULAR Nadelhalter.....	111
POTTS-SMITH chirurgische Pinzetten.....	58	VOLKMANN Wundhaken.....	94
PROVIDENCE-HOSPITAL Arterienklemmen.....	77	WALTER Meißel	129
QUINBY Schere	33	WANGENSTEEN Pinzetten.....	53
RAGNELL-DAVIS Wundhaken.....	95	WATSON Dermatome	10
RAMPLEY Schwammzangen.....	83	WATSON-CHEYNE Raspatorium.....	137
Raspatorien - Elevatorien.....	136-137, 139	WAUGH Pinzetten.....	57
REES Bulldog Schere.....	42	WEBSTER Nadelhalter.....	106
REES Scheren	42	Weichteilhaken für die Kieferchirurgie.....	100-101
REYNOLDS (JAMESON) Scheren.....	36	WEITLANER-LOKTITE Wundsperrer.....	102
REYNOLDS Scheren PRIMUS .INE	19	WILDER Tränenkanal-Dilatatoren.....	159
RIBBON STEVENS Scheren.....	34	WILLIAMS Gewebefasszange.....	82
RUBIN Meißel.....	129	WILLIAMS Tränenkanal-Dilatatoren.....	158
RUBIN Septumzange.....	149	WULLSTEIN Wundsperrer.....	103
RUSKIN Hohlmeißelzangen.....	156	Wundhaken	94-101
RUSKIN-LISTON Knochensplitterzangen.....	157	Wundsperrer	102-103
RYDER Nadelhalter.....	113	YANCOSKIE Wundhaken.....	98
SAROT Nadelhalter.....	110	YASARGIL Mikro-Nadelhalter.....	119
Scheren	16-51	ZAUFAL-JANSEN Hohlmeißelzange.....	156
Scheren für plastische Operationen.....	36-41		
Scheren, Augen-.....	45-47		
Scheren, chirurgische.....	24-30		
Scheren, Face-Lift.....	42-43		
Scheren, feine	32-34		
Scheren, Iris-.....	31		
Scheren, Mikro-.....	48-51		
Scheren, Nasen-.....	44		
Scheren, Präparier-.....	28-30		
Scheren, Sehnen-.....	35		
SCHINK Dermatome.....	9		
SCHWARZ Nasenspekulum.....	140		
Sehnenschnitzzangen.....	152-153		
Sehnenscheren.....	35		
Sehnensplitter.....	150-151		
SEMKEN Pinzetten.....	52		
SENN-MUELLER Wundhaken.....	94		
Septum-Elevatorien.....	132-135		
Septumzangen	148-149		
SHEA Scheren	45		
SHEEHAN Nasenmeißel.....	130		
SILVER Nasenmeißel.....	130		
Skalpgriffe	7		
Skalpklappen	8		
STELLBRINK Hohlmeißelzangen.....	155		
STEVENS Scheren.....	35		
STEVENS Scheren PRIMUS .INE	21		
Strabismus-Scheren.....	32		
STRANDELL-STILLE Wundhaken.....	94		
TAYLOR Pinzetten.....	59		
THOMS-ALLIS Gewebefasszange.....	82		
THOREK Schere	44		
TIECK-HALLE Nasenspekulum.....	140		
TIERSCH Dermatome	9		



**Inhaltsverzeichnis
Index**

Tables de matières

Indice57
Indice

ADLERKREUTZ forceps54, 55
ADSON forceps80
ADSON haemostatic forceps80
ADSON-BROWN forceps54
ADSON-GRAEFE forceps54
ALLIS tissue holding forceps82
ALLIS tissue holding forceps **PRIMUSLINE**71
ALLIS-ADAIR tissue holding forceps82
ALLIS-BABY tissue holding forceps82
ALM self retaining retractors95
Anatomic forceps - dressing forceps52-59
Applying forceps for vessel clips68
Applying forceps, vessel clips69
Applying forceps, vessel clips BIEMER67
Areola markers11
ASCH septum forceps148
Atraumatic forceps60-62
AUFRICHT nasal hooks86
AUFRICHT nasal rasps144
AUFRICHT scissors40
BABCOCK tissue holding forceps **PRIMUSLINE**71
BABY-ADSON haemostatic forceps81
BABY-CRILE-WOOD needle holder106
BABY-METZENBAUM scissors **PRIMUSLINE**17
BABY-MIXTER haemostatic forceps81
BALLENGER-HAJEK septum elevators132
BARRAQUER micro-needle holders117
BARRAQUER needle holders114
BARRON scalpel handle7
BELUCCI self retaining retractors103
BEUSE scissors34
BEYER bone rongeur156
BIEMER applying forceps, vessel clips67
Blepharoplasty scissors45-47
BLUMENTHAL bone rongeurs154
BOETTCHER nasal scissors44
BÖHLER bone cutting forceps157
BÖHLER bone rongeurs155
Bone crusher160
Bone cutting forceps157
Bone rongeurs154-156
BONN blepharoplasty scissors45
BOWMAN lacrimal dilators158
BRAND tendon holding forceps152
BROPHY (SULLIVAN) scissors27
BROPHY dissecting forceps58
BUNELL tendon strippers150, 151
CAPLAN septum forceps149
CAROLL tendon holding forceps153
CASTANARES face-lift scissors43
CASTROVIEJO micro scissors50
CASTROVIEJO micro-needle holders115
CASTROVIEJO-JACOBSON needle holders114
CHANG areola marker11
Chisels for rhinoplasty125-131
CINELLI chisels127
COLLIN mallet123
CONVERSE nasal hook86
CONVERSE scissors34
CORONAL LIFT retractor98

COTTLE bone crusher160
COTTLE chisels125, 126, 128
COTTLE elevators132-135
COTTLE nasal rasp144
COTTLE nasal specula141-142
COTTLE trachea hooklets84, 85, 87, 88
COTTLE-KAZANJIAN bone cutting forceps157
COTTLE-NEIVERT nasal hooklet88
COTTLE-WALSHAM septum forceps148
Cotton swab und sponge holding forceps83
CRILE haemostatic forceps78
CRILE haemostatic forceps **PRIMUSLINE**73
CRILE nasal hooks85
CRILE-MURRAY needle holder105
CRILE-RANKIN haemostatic forceps78
CRILE-RANKIN haemostatic forceps **PRIMUSLINE**73
CRILE-WOOD needle holders105
CUSHING dressing forceps52
DANDY haemostatic forceps77
DAVIS face-lift scissors42
DE BAKEY atraumatic forceps61, 62
DE BAKEY BAYONET atraumatic forceps60
DE Bakey needle holders111
DE BAKEY-GERALD atraumatic forceps60
DERF needle holders105
Dermatomes9-10
DESMARRES retractor90
DIETHRICH needle holders113
Dissecting forceps - Dressing forceps52-59
Dissecting scissors24-30
DUEHRSEN dressing forceps57
Face-lift scissors42-43
FERREIRA mamaplasty retractors92
FERREIRA retractors99
Fine scissors32-34
FISCHER tendon strippers151
FOERSTER (BALLENGER) sponge holding forceps83
FOMON chisels127
FOMON nasal hooklet84, 88
FOMON nasal rasps145-146
FOMON nasal scissors44
Forceps52-65
Forceps, atraumatic60-62
Forceps, micro-63-65
FOSTER-GILLIES needle holders109
FREEMAN areola markers11
FREEMAN retractors96-97, 99
FREEMAN-KAYE scissors40
FREER elevators133, 135
FRIEDMAN bone rongeur154
GALLAHER nasal rasps145
GERALD dressing forceps59
GILLIES dissecting forceps53
GILLIES nasal hooklet84
GILLIES needle holders109
GOLDMAN-FOX scissors41
GORNEY PLATYSMA scissors38
GORNEY retractors96
GORNEY scissors37
GORNEY-DELICATE scissors39



**Inhaltsverzeichnis
Index**
Tables de matières
Indice38
Indice

GORNEY-FREEMAN scissors	
GRADLE scissors.....	32
GRAEFE forceps.....	56
GREENBERG PAR scissors.....	46
GREGORY scissors.....	43
GROSSMAN areola marker.....	11
Haemostatic forceps.....	71-81
Haemostatic forceps PRIMUS .INE.....	71-75
HAJEK mallet.....	123
HALLE elevator.....	132
HALSEY needle holders.....	107
HALSTED-MOSQUITO haemostatic forceps.....	76
HALSTED-MOSQUITO haemostatic forceps PRIMUS INE.....	72
HARTMANN haemostatic forceps.....	76
HARTMANN haemostatic forceps PRIMUS .INE.....	72
HARTMANN-HALLE nasal specula.....	140
HEANEY needle holders.....	110
HEGAR-BAUMGARTNER needle holders.....	106
HOLTZHEIMER self retaining retractors.....	95
HUMBY dermatome.....	10
Instrument trays, stainless steel.....	161
Iris scissors.....	31
ITERSON trachea hooklets.....	88
JACKSON trachea hooklets.....	89
JACOBSON micro-needle holders.....	116
JOSEPH elevator.....	132
JOSEPH nasal hooklet.....	85
JOSEPH nasal saws.....	143
JOSEPH scissors.....	37
JOSEPH scissors PRIMUS .INE.....	20
KAHN scissors.....	41
KAYE BLEPHAROPLASTY scissors.....	47
KAYE RIBBON TYPE scissors.....	47
KAYE scissors.....	39
KELLY haemostatic forceps.....	79
KELLY haemostatic forceps PRIMUS .INE.....	73
KELLY scissors.....	26
KELLY scissors PRIMUS .INE.....	20
KELLY-RANKIN haemostatic forceps.....	79
KELLY-RANKIN haemostatic forceps PRIMUS INE.....	73
KILIAN chisel.....	125
KILIAN nasal specula.....	142
KILIAN-CALUS chisel.....	125
KILNER (RAGNELL) scissors.....	36
KILNER nasal hooklet.....	84, 87
KILNER needle holder.....	110
KLEINERT-KURTZ tendon strippers.....	151
KNAPP (ROLLET) trachea hooklet.....	90
KNAPP scissors.....	32
KNIGHT nasal scissors.....	44
KOCHER haemostatic forceps.....	80
KOCHER haemostatic forceps PRIMUS .INE.....	74
KOCHER-FINO haemostatic forceps PRIMUS INE.....	75
Lacrimal dilators.....	158-159
LANGE trachea hooklet.....	84
Leadhands.....	12
LERICHE haemostatic forceps.....	79
LEXER scissors.....	26
LEXER scissors PRIMUS LINE.....	18
LICHTENBERG needle holders.....	113

LOCKLIN scissors.....	33
LOCKWOOD tissue holding forceps.....	82
LUCAE mallets.....	124
LUKENS trachea hooklet.....	89
MACCOLLUM-DINGMAN mamaplasty retractor.....	92
Mallets.....	123-124
Mamaplasty retractors.....	91-93
MARQUARDT bone rongeur.....	156
MARTINEZ-KILNER nasal hooklet.....	87
MASING elevator.....	135
MATHIEU-OLSEN needle holders.....	106
MAYO scissors.....	24
MAYO-HEGAR needle holders.....	108
MAYO-LEXER scissors PRIMUS .INE.....	18
MAYO-STILLE scissors PRIMUS .INE.....	19
MC DONALD periosteal raspatory.....	137
MC INDOE dressing forceps.....	53
MC INDOE scissors.....	33
MEAD mallets.....	123
Measuring instruments.....	11
METZENBAUM scissors PRIMUS .INE.....	16
METZENBAUM-FINO scissors.....	30
METZENBAUM-FINO scissors PRIMUS INE.....	17
METZENBAUM-NELSON scissors.....	28-29
MEYERDING retractors.....	95
MICRO-ADSON forceps.....	54-55
Micro-blade holder - micro-blades.....	6
Micro-forceps.....	63-65
MICRO-MOSQUITO haemostatic forceps.....	76
MICRO-MOSQUITO haemostatic forceps PRIMUS INE.....	72
Micro-needle holders.....	115-122
Micro-needle holders, round handle.....	117-119
Micro-scissors.....	48-50
MIDDLETON-JANSEN septum forceps.....	149
MILIGAN self retaining retractor.....	103
MINI-FRIEDMAN bone rongeurs.....	154
MINI-RYDER needle holders.....	113
MODELL WIEN nasal specula.....	141
MOSQUITO-DANDY haemostatic forceps.....	77
Nasal and trachea hooklets.....	84-88
Nasal rasps.....	144-146
Nasal rasps with TC.....	146
Nasal saws.....	143
Nasal scissors.....	44
Nasal specula.....	140-142
Needle holders.....	105-122
Needle holders, Micro-.....	115-122
Needle holders, Titanium-.....	121-122
NEIVERT chisel.....	131
NEIVERT needle holder.....	110
NEIVERT trachea hooklet.....	88
NEIVERT-ANDERSON chisels.....	131
NEUMANN scissors.....	33
OBWEGESER periosteal raspatories.....	136, 139
OBWEGESER retractors.....	100-101
OEHLER dressing forceps.....	53
OLSEN-HEGAR needle holders.....	107
Osteotomes for maxillo-facial surgery.....	107
PARTSCH mallet.....	124
PAR-TYPE scissors.....	46



Inhaltsverzeichnis
Index

Tables de matières
Indice
Indice

PÉAN haemostatic forceps PRIMUS INE	74
PÉAN-FINO haemostatic forceps PRIMUS INE	75
PECK-JOSEF scissors.....	27
Periosteal raspatories - elevators.....	136-137, 139
PIERSE micro-forceps.....	65
POTTS-SMITH dressing forceps.....	58
Probes	159
PROVIDENCE-HOSPITAL haemostatic forceps.....	77
QUINBY scissors.....	33
RAGNELL-DAVIS retractor.....	95
RAMPLEY sponge holding forceps.....	83
REES Bulldog scissors.....	42
REES scissors	42
Retractors	94-101
REYNOLDS (JAMESON) scissors.....	36
REYNOLDS scissors PRIMUS INE	19
RIBBON STEVENS scissors.....	34
RUBIN chisels	129
RUBIN septum forceps.....	149
RUSKIN bone rongeurs.....	156
RUSKIN-LISTON bone cutting forceps.....	157
RYDER needle holders.....	113
SAROT needle holders.....	110
Scalpel blades	8
Scalpel handle	7
SCHINK dermatome.....	9
SCHWARZ nasal speculum.....	140
Scissors	16-51
Scissors for plastic surgery.....	36-41
Scissors, blepharoplasty.....	45-47
Scissors, dissecting.....	24-30
Scissors, face-lift.....	42-43
Scissors, fine	32-34
Scissors, Iris.....	31
Scissors, micro.....	48-51
Scissors, nasal.....	44
Scissors, tendon.....	35
Self retaining retractors.....	102-103
SEMKEN forceps	52
SENN-MUELLER retractors.....	94
Septum forceps.....	148-149
Septum-elevators.....	132-135
SHEA scissors	45
SHEEHAN nasal chisels.....	130
SILVER nasal chisels.....	130
Soft tissue retractors for maxillo facial surgery.....	100-101
STELLBRINK bone rongeurs.....	155
STEVENS scissors.....	35
STEVENS scissors PRIMUS INE	21
Strabismus scissors.....	32
STRANDELL-STILLE retractors.....	94
TAYLOR forceps.....	59
Tendon holding forceps.....	152-153
Tendon strippers.....	150-151
Tenotomy scissors.....	35
THOMS-ALLIS tissue holding forceps.....	82
THOREK scissors.....	44
TIECK-HALLE nasal speculum.....	140
TIERSCH dermatome.....	9

Tissue and intestinal holding forceps.....	82
Tissue and intestinal holding forceps PRIMUS INE	71
Trachea hooklets.....	89-90
TRAVERS self retaining retractor.....	103
TYP JUWELIER micro-forceps.....	64
ULTRA-MICRO-ADSON (BRAKA) forceps.....	55
VANNAS micro-scissors.....	50
VASCULAR needle holders.....	111
Vessel dilators	66
VOLKMANN retractors.....	94
WALTER chisels.....	129
WANGENSTEEN forceps.....	53
WATSON dermatome.....	10
WATSON-CHEYNE periosteal raspatory.....	137
WAUGH forceps.....	57
WEBSTER needle holders.....	106
WEITLANER-LOKTITE self retaining retractors.....	102
WILDER lacrimal dilators.....	159
WILLIAMS lacrimal dilators	158
WILLIAMS tissue holding forceps.....	82
WULLSTEIN self retaining retractors.....	103
YANCOSKIE retractor.....	98
YASARGIL micro-needle holders.....	119
ZAUFAL-JANSEN bone rongeur.....	156



**Inhaltsverzeichnis
Index**
**Tables de matières
Indice
Indice**

ADLERKREUTZ pincés à dissection.....	57	COLLIN maillet.....	123
ADSON pincés à dissection.....	54, 55	Contenaires d'instruments.....	161
ADSON pincés hémostatiques.....	80	CONVERSE ciseaux.....	34
ADSON-BROWN pincés à dissection.....	54	CONVERSE écarteur nasal.....	86
ADSON-GRAEFE pince à dissection.....	54	CORONAL LIFT écarteur.....	98
ALLIS pincés à tissu.....	82	COTTLE broyeur pour os.....	160
ALLIS pincés à tissu PRIMUS .INE.....	71	COTTLE ciseaux-burins.....	125, 126, 128
ALLIS-ADAIR pince à tissu.....	82	COTTLE écarteurs trachéales.....	84, 85, 87, 88
ALLIS-BABY pince à tissu.....	82	COTTLE éleveurs.....	132-135
ALM écarteurs autostatiques.....	95	COTTLE râpe nasal.....	144
Approximateurs, clips.....	69	COTTLE spéculums nasaux.....	141-142
Approximateurs, clips, Biemer.....	67	COTTLE-KAZANJIAN pince coupante à os.....	157
ASCH pince pour la cloison nasal.....	148	COTTLE-NEIVERT écarteur nasal.....	88
AUFRIEHT ciseaux.....	40	COTTLE-WALSHAM pincés pour la cloison nasal.....	148
AUFRIEHT écarteurs nasales.....	86	CRILE écarteurs nasales.....	85
AUFRIEHT râpes nasales.....	144	CRILE pincés hémostatiques.....	78
BABCOCK pincés à tissu PRIMUS .INE.....	71	CRILE pincés hémostatiques PRIMUS .INE.....	73
BABY-ADSON pincés hémostatiques.....	81	CRILE-MURRAY porte-aiguilles.....	105
BABY-CRILE-WOOD porte-aiguilles.....	106	CRILE-RANKIN pincés hémostatiques.....	78
BABY-METZENBAUM ciseaux PRIMUS .INE.....	17	CRILE-RANKIN pincés hémostatiques PRIMUS .INE.....	73
BABY-MIXTER pincés hémostatiques.....	81	CRILE-WOOD porte-aiguilles.....	105
BALLENGER-HAJEK éleveurs pour la cloison nasal.....	132	CUSHING pincés à dissection.....	52
BARRAQUER porte-aiguilles.....	114	DANDY pincés hémostatiques.....	77
BARRAQUER porte-aiguilles micro.....	117	DAVIS ciseaux pour le face-lift.....	42
BARRON manche de bistouri.....	7	DE BAKEY BAYONET pincés à dissection atraumatiques.....	60
BELUCCI écarteurs autostatiques.....	103	DE BAKEY pincés à dissection atraumatiques.....	61, 62
BEUSE ciseaux.....	34	DE Bakey porte-aiguilles.....	111
BEYER pince gouge.....	156	DE BAKEY-GERALD pincés à dissection atraumatiques.....	60
BIEMER approximateurs, clips.....	67	DERF porte-aiguilles.....	105
BLUMENTHAL pincés gouges.....	154	Dermatomes.....	9-10
BOETTCHER ciseaux nasal.....	44	DESMARRES écarteurs.....	90
BÖHLER pincés coupantes à os.....	157	DIETHRICH porte-aiguilles.....	113
BÖHLER pincés gouges.....	155	Dilatateurs pour le canal lacrymal.....	158-159
BONN ciseaux pour blépharoplastie.....	45	Dilatateurs vasculaires.....	66
BOWMAN dilatateurs pour le canal lacrymal.....	158	DUEHRSSSEN pince à dissection.....	57
BRAND pincés pour saisir les tendons.....	152	Ecarteurs.....	94-101
BROPHY (SULLIVAN) ciseaux.....	27	Ecarteurs autostatiques.....	102-103
BROPHY pincés à dissection à griffes.....	58	Ecarteurs mammaires.....	91-93
Broyeur pour os.....	160	Ecarteurs pour la chirurgie maxillo-faciale.....	100-101
BUNELL instruments à écorcher les tendons.....	150, 151	Ecarteurs trachéales.....	89-90
CAPLAN pince pour la cloison nasal.....	149	Ecarteurs trachéales et nasales.....	84-88
CAROLL pince pour saisir les tendons.....	153	Eleveurs pour la cloison nasale.....	132-135
CASTANARES ciseaux pour le face-lift.....	43	FERREIRA écarteurs.....	99
CASTROVIEJO ciseaux micro.....	50	FERREIRA écarteurs mammaires.....	92
CASTROVIEJO porte-aiguilles micro.....	115	FISCHER instruments à écorcher les tendons.....	151
CASTROVIEJO-JACOBSON porte-aiguilles.....	114	FOERSTER (BALLENGER) pincés à éponges.....	83
CHANG marqueur pour l'aréole.....	11	FOMON ciseaux nasales.....	44
CINELLI ciseaux-burins.....	127	FOMON ciseaux-burins.....	127
Ciseaux.....	16-51	FOMON écarteurs nasales.....	84, 88
Ciseaux à chirurgie.....	24-27	FOMON râpes nasales.....	145-146
Ciseaux à chirurgie – ciseaux à dissection.....	28-30	FOSTER-GILLIES porte-aiguilles.....	109
Ciseaux à iridectomie.....	31	FREEMAN écarteurs.....	96-97, 99
Ciseaux à strabisme.....	32	FREEMAN marqueurs pour l'aréole.....	11
Ciseaux à tendons.....	35	FREEMAN-KAYE ciseaux.....	40
Ciseaux fines.....	32-34	FREER éleveurs.....	133, 135
Ciseaux nasales.....	44	FRIEDMAN pince gouge.....	154
Ciseaux pour blépharoplastie.....	45-47	GALLAHER râpes nasales.....	145
Ciseaux pour la chirurgie plastique.....	36-41	GERALD pincés à dissection.....	59
Ciseaux pour le face-lift.....	42-43	GILLIES écarteur nasal.....	84
Ciseaux, micro.....	48-51	GILLIES pince à dissection à griffes.....	53



Inhaltsverzeichnis
Index

Tables de matières
Indice
Indice

GOLDMAN-FOX ciseaux.....	41
GORNEY ciseaux.....	37
GORNEY écarteur.....	96
GORNEY PLATYSMA ciseaux.....	38
GORNEY-DELICATE ciseaux.....	39
GORNEY-FREEMAN ciseaux.....	38
GRADLE ciseaux.....	32
GRAEFE pinces à dissection.....	56
GREENBERG PAR ciseaux.....	46
GREGORY ciseaux.....	43
GROSSMAN marqueur pour l'aréole.....	11
HAJEK maillet.....	123
HALLE éleveur.....	132
HALSEY porte-aiguilles.....	107
HALSTED-MOSQUITO pinces hémostatiques.....	76
HALSTED-MOSQUITO pinces hémostatiques PRIMUSINE	72
HARTMANN pinces hémostatiques.....	76
HARTMANN pinces hémostatiques PRIMUSINE	72
HARTMANN-HALLE spéculums nasaux.....	140
HEANEY porte-aiguilles.....	110
HEGAR-BAUMGARTNER porte-aiguilles.....	106
HOLTZHEIMER écarteurs autostatiques.....	95
HUMBY dermatome.....	10
Instruments à écorcher les tendons.....	150-151
Instruments à mesurer.....	11
ITERSON écarteurs trachéales.....	88
JACKSON écarteurs trachéales.....	89
JACOBSON porte-aiguilles micro.....	116
JOSEPH ciseaux.....	37
JOSEPH ciseaux PRIMUSINE	20
JOSEPH écarteur nasal.....	85
JOSEPH éleveur.....	132
JOSEPH scies nasales.....	143
KAHN ciseaux.....	41
KAYE BLEPHAROPLASTY ciseaux.....	47
KAYE ciseaux.....	39
KAYE RIBBON TYPE ciseaux.....	47
KELLY ciseaux.....	26
KELLY ciseaux PRIMUSINE	20
KELLY pinces hémostatiques.....	79
KELLY pinces hémostatiques PRIMUSINE	73
KELLY-RANKIN pinces hémostatiques.....	79
KELLY-RANKIN pinces hémostatiques PRIMUSINE	73
KILIAN ciseaux-burin.....	125
KILIAN spéculums nasaux.....	142
KILIAN-CALUS ciseaux-burin.....	125
KILNER (RAGNELL) ciseaux.....	36
KILNER écarteurs nasales.....	84, 87
KILNER porte-aiguilles.....	110
KLEINERT-KURTZ instruments à écorcher les tendons.....	151
KNAPP (ROLLET) écarteur trachéal.....	90
KNAPP ciseaux.....	32
KNIGHT ciseaux nasal.....	44
KOCHER pinces hémostatiques.....	80
KOCHER pinces hémostatiques PRIMUSINE	74
KOCHER-FINO pinces hémostatiques PRIMUSINE	75
Lames de bistouris.....	8
LANGÉ écarteur trachéal.....	84
LERICHE pinces hémostatiques.....	79

LEXER ciseaux.....	26
LEXER ciseaux PRIMUSINE	18
LICHTENBERG porte-aiguilles.....	113
LOCKLIN ciseaux.....	33
LOCKWOOD pince à tissu.....	82
LUCAE maillets.....	124
LUKENS écarteur trachéal.....	89
MACCOLLUM-DINGMAN écarteur mammaire.....	92
Maillets.....	123-124
Mains en plomb.....	12
Manches de bistouri.....	7
MARQUARDT pince gouge.....	156
Marqueurs pour l'aréole.....	11
MARTINEZ-KILNER écarteur nasal.....	87
MASING éleveur.....	135
MATHIEU-OLSEN porte-aiguilles.....	106
MAYO ciseaux.....	24
MAYO-HEGAR porte-aiguilles.....	108
MAYO-LEXER ciseaux PRIMUSINE	18
MAYO-STILLE ciseaux PRIMUSINE	19
MC DONALD rugine.....	137
MC INDOE ciseaux.....	33
MC INDOE pinces à dissection.....	53
MEAD maillets.....	123
METZENBAUM ciseaux PRIMUSINE	16
METZENBAUM-FINO ciseaux.....	30
METZENBAUM-FINO ciseaux PRIMUSINE	17
METZENBAUM-NELSON ciseaux.....	28-29
MEYERDING écarteurs.....	95
MICRO-ADSON pinces à dissection.....	54-55
Micro-ciseaux.....	48-50
MICRO-MOSQUITO pinces hémostatiques.....	76
MICRO-MOSQUITO pinces hémostatiques PRIMUSINE	72
Micro-pinces à dissection.....	63-65
MIDDLETON-JANSEN pinces pour la cloison nasal.....	149
MILIGAN écarteur autostatique.....	103
MINI-FRIEDMAN pinces gouges.....	154
MINI-RYDER porte-aiguilles.....	113
MODELL WIEN spéculums nasaux.....	141
MOSQUITO-DANDY pince hémostatique.....	77
NEIVERT ciseaux-burin.....	131
NEIVERT écarteur trachéal.....	88
NEIVERT porte-aiguilles.....	110
NEIVERT-ANDERSON ciseaux-burins.....	131
NEUMANN ciseaux.....	33
OBWEGESER écarteurs.....	100-101
OBWEGESER rugines.....	136, 139
OEHLER pinces à dissection à griffes.....	53
OLSEN-HEGAR porte-aiguilles.....	107
Ostéotomes pour la chirurgie maxillo-faciale.....	138
Ostéotomes, ciseaux-burins pour rhinoplastique.....	125-131
PARTSCH maillet.....	124
PAR-TYPE ciseaux.....	46
PÉAN pinces hémostatiques.....	78
PÉAN pinces hémostatiques PRIMUSINE	74
PÉAN-FINO pinces hémostatiques PRIMUSINE	75
PECK-JOSEF ciseaux.....	27
PIERSE micro-pinces à dissection.....	65
Pinces à dissection.....	52-65
Pinces à dissection - pinces à dissection à griffes.....	52-59



**Inhaltsverzeichnis
Index**
**Tables de matières
Indice
Indice**

Pincés à dissection à griffes - pincés à dissection.....	52-59
Pincés à dissection, atraumatiques.....	60-62
Pincés à dissection, atraumatiques.....	60-62
Pincés à dissection, Micro.....	63-65
Pincés à poser des clips.....	68
Pincés à tampons et éponges.....	83
Pincés coupantes à os.....	157
Pincés gouges.....	154-156
Pincés hémostatiques.....	71-81
Pincés hémostatiques PRIMUS .INE	71-75
Pincés intestinales et de tissu.....	82
Pincés intestinales et de tissu PRIMUS .INE	71
Pincés pour la cloison nasal.....	148-149
Pincés pour saisir les tendons.....	152-153
Porte-aiguilles - micro-lames.....	6
Porte-aiguilles.....	105-122
Porte-aiguilles micro.....	115-122
Porte-aiguilles micro manche ronde.....	117-119
Porte-aiguilles, Titane.....	121-122
POTTS-SMITH pincés à dissection à griffes.....	58
PROVIDENCE-HOSPITAL pincés hémostatiques.....	77
QUINBY ciseaux.....	33
RAGNELL-DAVIS écarteur.....	95
RAMPLEY pincés à éponges.....	83
Râpes nasales	144-146
Râpes nasales, TC	146
REES ciseaux	42
REES ciseaux bulldog.....	42
REYNOLDS (JAMESON) ciseaux.....	36
REYNOLDS ciseaux PRIMUS .INE	19
RIBBON STEVENS ciseaux.....	34
RUBIN ciseaux-burins.....	129
RUBIN pince pour la cloison nasal.....	149
Rugines - éleveurs	136-137, 139
RUSKIN pincés gouges.....	156
RUSKIN-LISTON pincés coupantes à os.....	157
RYDER porte-aiguilles.....	113
SAROT porte-aiguilles.....	110
SCHINK dermatome.....	9
SCHWARZ spéculum nasal.....	140
Scies nasales	143
SEMKEN pincés à dissection.....	52
SENN-MUELLER écarteurs.....	94
SHEA ciseaux.....	45
SHEEHAN ciseaux-burins pour rhinoplastique.....	130
SILVER ciseaux-burins pour rhinoplastique.....	130
Spéculums nasaux.....	140-142
STELLBRINK pincés gouges.....	155
STEVENS ciseaux.....	35
STEVENS ciseaux PRIMUS .INE	21
STRANDELL-STILLE écarteurs.....	94
Stylets	159
TAYLOR pincés à dissection.....	59
THOMS-ALLIS pince à tissu.....	82
THOREK ciseaux	44
TIECK-HALLE spéculum nasal.....	140
TIERSCH dermatome	9
TRAVERS écarteur autostatique.....	103
TYP JUWELIER micro-pincés à dissection.....	64
ULTRA-MICRO-ADSON (BRAKA) pince à dissection.....	55

VANNAS micro-ciseaux.....	50
VASCULAR porte-aiguilles.....	111
VOLKMANN écarteurs.....	94
WALTER ciseaux-burins.....	129
WANGENSTEEN pincés à dissection.....	53
WATSON dermatome.....	10
WATSON-CHEYNE rugine.....	137
WAUGH pincés à dissection.....	57
WEBSTER porte-aiguilles.....	106
WEITLANER-LOKTITE écarteurs autostatiques.....	102
WILDER dilateurs pour le canal lacrymal.....	159
WILLIAMS dilateurs pour le canal lacrymal	158
WILLIAMS pince à tissu.....	82
WULLSTEIN écarteurs autostatiques.....	103
YANCOSKIE écarteur.....	98
YASARGIL micro-porte-aiguilles.....	119
ZAUFAL-JANSEN pince gouge.....	156



Inhaltsverzeichnis
Index

Tables de matières
Indice
Indice

ADSON pinzas de disección.....	54, 55
ADSON pinzas hemostáticas.....	80
ADSON-BROWN pinzas de disección.....	54
ADSON-GRAEFE pinza de disección.....	54
ALLIS pinzas para tejidos.....	82
ALLIS pinzas para tejidos PRIMUS INE.....	71
ALLIS-ADAIR pinza para tejidos.....	82
ALLIS-BABY pinza para tejidos.....	82
ALM separadores autoestáticos.....	95
Aplicadores para clips.....	68
Approximadores, clips.....	69
Approximadores, clips, Biemer.....	67
ASCH pinza para el tabique nasal.....	148
AUFRICHT limas nasales.....	144
AUFRICHT separadores nasales.....	86
AUFRICHT tijeras.....	40
BABCOCK pinzas para tejidos PRIMUS INE.....	71
BABY-ADSON pinzas hemostáticas.....	81
BABY-CRILE-WOOD porta agujas.....	106
BABY-METZENBAUM tijeras PRIMUS INE.....	17
BABY-MIXTER pinzas hemostáticas.....	81
BALLENGER-HAJEK elevadores para el tabique nasal.....	132
BARRAQUER porta agujas.....	114
BARRAQUER porta agujas micro.....	117
BARRON manche de bistouri.....	7
BELUCCI separadores autoestáticos.....	103
BEUSE tijeras.....	34
BEYER pinza gubia.....	156
BIEMER aproximadores, clips.....	67
BLUMENTHAL pinzas gubias.....	154
BOETTCHEER tijera nasal.....	44
BÖHLER pinzas cortantes para huesos.....	157
BÖHLER pinzas gubias.....	155
BONN tijeras para blefaroplastica.....	45
BOWMAN dilatadores para el canal lacrimal.....	158
BRAND pinzas para saisir les tendons.....	152
BROPHY (SULLIVAN) tijeras.....	27
BROPHY pinzas de disección con dientes.....	58
BUNELL enucleador de tendones.....	150, 151
CAPLAN pinza para el tabique nasal.....	149
CAROLL pinza para tendones.....	153
CASTANARES tijeras para el face-lift.....	43
CASTROVIEJO porta agujas micro.....	115
CASTROVIEJO tijeras micro.....	50
CASTROVIEJO-JACOBSON porta agujas.....	114
CHANG marcador para aéola.....	11
Cinceles para la cirugía maxilofacial.....	138
Cinceles para rinoplastica.....	125-131
CINELLI cinceles.....	127
COLLIN martillo.....	123
Contenedores para instrumentos.....	161
CONVERSE separador nasal.....	86
CONVERSE tijeras.....	34
CORONAL LIFT separador.....	98
COTTLE cinceles.....	125, 126, 128
COTTLE elevadores.....	132-135
COTTLE espéculos nasales.....	141-142
COTTLE lima nasal.....	144
COTTLE prensa para huesos.....	160

COTTLE separadores traqueales.....	84, 85, 87, 88
COTTLE-KAZANJIAN pinza cortante para huesos.....	157
COTTLE-NEIVERT separador nasal.....	88
COTTLE-WALSHAM pinzas para el tabique nasal.....	148
CRILE pinzas hemostáticas.....	78
CRILE pinzas hemostáticas PRIMUS INE.....	73
CRILE separadores nasales.....	85
CRILE-MURRAY porta agujas.....	105
CRILE-RANKIN pinzas hemostáticas.....	78
CRILE-RANKIN pinzas hemostáticas PRIMUS INE.....	73
CRILE-WOOD porta agujas.....	105
CUSHING pinzas de disección.....	52
DANDY pinzas hemostáticas.....	77
DAVIS tijeras para el face-lift.....	42
DE BAKEY BAYONET pinzas de disección atraumaticas.....	60
DE BAKEY pinzas de disección atraumaticas.....	61, 62
DE Bakey porta agujas.....	111
DE BAKEY-GERALD pinzas de disección atraumaticas.....	60
DERF porta agujas.....	105
Dermatomos.....	9-10
DESMARRES separadores.....	90
DIETHRICH porta agujas.....	113
Dilatadores para el canal lacrimal.....	158-159
Dilatadores vasculares.....	66
DUEHRSEN pinza de disección.....	57
Elevadores para el tabique nasal.....	132-135
Enucleadores de tendones.....	150-151
Espéculos nasales.....	140-142
FERREIRA separadores.....	99
FERREIRA separadores mamarias.....	92
FISCHER enucleador de tendones.....	151
FOERSTER (BALLENGER) pinzas para esponjas.....	83
FOMON cinceles.....	127
FOMON limas nasales.....	145-146
FOMON separadores nasales.....	84, 88
FOMON tijeras nasales.....	44
FOSTER-GILLIES porta agujas.....	109
FREEMAN marcadores para aéola.....	11
FREEMAN separadores.....	96-97, 99
FREEMAN-KAYE tijeras.....	40
FREER elevadores.....	133, 135
FRIEDMAN pinza gubia.....	154
GALLAHER limas nasales.....	145
GERALD pinzas de disección.....	59
GILLIES pinza de disección con dientes.....	53
GILLIES porta agujas.....	109
GILLIES separador nasal.....	84
GOLDMAN-FOX tijeras.....	41
GORNEY PLATYSMA tijeras.....	38
GORNEY separador.....	96
GORNEY tijeras.....	37
GORNEY-DELICATE tijeras.....	39
GORNEY-FREEMAN tijeras.....	38
GRADLE tijeras.....	32
GRAEFE pinzas de disección.....	56
GREENBERG PAR tijeras.....	46
GREGORY tijeras.....	43
GROSSMAN marcador para aéola.....	11
HAJEK martillo.....	123
HALLE elevador.....	132



**Inhaltsverzeichnis
Index**
**Tables de matières
Indice
Indice**

HALSEY porta agujas.....	107	MARTINEZ-KILNER separador nasal.....	87
HALSTED-MOSQUITO pinzas hemostáticas.....	76	MASING elevador.....	135
HALSTED-MOSQUITO pinzas hemostáticas PRIMUSINE	72	MATHIEU-OLSEN porta agujas.....	106
HARTMANN pinzas hemostáticas.....	76	MAYO tijeras.....	24
HARTMANN pinzas hemostáticas PRIMUSINE	72	MAYO-HEGAR porta agujas.....	108
HARTMANN-HALLE espéculos nasales.....	140	MAYO-LEXER tijeras PRIMUSINE	18
HEANEY porta agujas.....	110	MAYO-STILLE tijeras PRIMUSINE	19
HEGAR-BAUMGARTNER porta agujas.....	106	MC DONALD raspatorio.....	137
Hojas de busturí.....	8	MC INDOE pinzas de disección.....	53
HOLTZHEIMER separadores autoestáticos.....	95	MC INDOE tijeras.....	33
HUMBY dermatomo.....	10	MEAD martillos.....	123
Instrumentos de medida.....	11	METZENBAUM tijeras PRIMUSINE	16
ITERSON separadores traqueales.....	88	METZENBAUM-FINO tijeras.....	30
JACKSON separadores traqueales.....	89	METZENBAUM-FINO tijeras PRIMUSINE	17
JACOBSON porta agujas micro.....	116	METZENBAUM-NELSON tijeras.....	28-29
JOSEPH elevador.....	132	MEYERDING separadores.....	95
JOSEPH separador nasal.....	85	MICRO-ADSON pinzas de disección.....	54-55
JOSEPH sierras nasales.....	143	MICRO-MOSQUITO pinzas hemostáticas.....	76
JOSEPH tijeras.....	37	MICRO-MOSQUITO pinzas hemostáticas PRIMUSINE	72
JOSEPH tijeras PRIMUSINE	20	Micro-pinzas de disección.....	63-65
KAHN tijeras.....	41	Micro-tijeras.....	48-50
KAYE BLEPHAROPLASTY tijeras.....	47	MIDDLETON-JANSEN pinzas para el tabique nasal.....	149
KAYE RIBBON TYPE tijeras.....	47	MILIGAN separador autoestático.....	103
KAYE tijeras.....	39	MINI-FRIEDMAN pinzas gubias.....	154
KELLY pinzas hemostáticas.....	79	MINI-RYDER porta agujas.....	113
KELLY pinzas hemostáticas PRIMUSINE	73	MODELL WIEN espéculos nasales.....	141
KELLY tijeras.....	26	MOSQUITO-DANDY pinza hemostática.....	77
KELLY tijeras PRIMUSINE	20	NEIVERT cincel.....	131
KELLY-RANKIN pinzas hemostáticas.....	79	NEIVERT porta agujas.....	110
KELLY-RANKIN pinzas hemostáticas PRIMUSINE	73	NEIVERT separador traqueal.....	88
KILIAN cincel.....	125	NEIVERT-ANDERSON cinceles.....	131
KILIAN espéculos nasales.....	142	NEUMANN tijeras.....	33
KILIAN-CALUS cincel.....	125	OBWEGESER raspatorios.....	136, 139
KILNER (RAGNELL) tijeras.....	36	OBWEGESER separadores.....	100-101
KILNER porta agujas.....	110	OEHLER pinzas de disección con dientes.....	53
KILNER separadores nasales.....	84, 87	OLSEN-HEGAR porta agujas.....	107
KLEINERT-KURTZ enucleador de tendones.....	151	PARTSCH martillo.....	124
KNAPP (ROLLET) separador traqueal.....	90	PAR-TYPE tijeras.....	46
KNAPP tijeras.....	32	PÉAN pinzas hemostáticas.....	78
KNIGHT tijeras nasal.....	44	PÉAN pinzas hemostáticas PRIMUSINE	74
KOCHER pinzas hemostáticas.....	80	PÉAN-FINO pinzas hemostáticas PRIMUSINE	75
KOCHER pinzas hemostáticas PRIMUSINE	74	PECK-JOSEF tijeras.....	27
KOCHER-FINO pinzas hemostáticas PRIMUSINE	75	Periostótomos - elevadores.....	136-137, 139
LANGE separador traqueal.....	84	PIERSE micro-pinzas de disección.....	65
LERICHE pinzas hemostáticas.....	79	Pinzas cortantes para huesos.....	157
LEXER tijeras.....	26	Pinzas de disección.....	52-65
LEXER tijeras PRIMUSINE	18	Pinzas de disección - pinzas de disección con dientes.....	52-59
LICHTENBERG porta agujas.....	113	Pinzas de disección atraumaticas.....	60-62
Limas nasales.....	144-146	Pinzas de disección, Micro-.....	63-65
Limas nasales, TC.....	146	Pinzas gubias.....	154-156
LOCKLIN tijeras.....	33	Pinzas hemostáticas.....	71-81
LOCKWOOD pinza para tejidos.....	82	Pinzas hemostáticas PRIMUSINE	71-75
LUCAE martillos.....	124	Pinzas para el tabique nasal.....	148-149
LUKENS separador traqueal.....	89	Pinzas para tampones y esponjas.....	83
MACCOLLUM-DINGMAN separador mamaria.....	92	Pinzas para tejidos y intestinos.....	82
Mangos de bisturí.....	7	Pinzas para tejidos y intestinos PRIMUSINE	71
Manos de plomo.....	12	Pinzas para tendones.....	152-153
Marcadores para aéola.....	11	Porta agujas.....	105-122
MARQUARDT pinza gubia.....	156	Porta agujas, Micro-.....	115-122
Martillos.....	123-124	Porta agujas, Micro-, mango redondo.....	117-119

Manufacturer & Exporter Of
Plastic Surgery Instruments



PLASTIC SURGERY
PLASTISCHE CHIRURGIE

