

SURGICAL

Instruments Catalogue



SURGICAL INSTRUMENTS



Email: www.adasinstruments.net

adas.surgical@gmail.com

whatsapp / viber :

0092 321 612 6625



SURGICAL HANDLES



No3L
AA-00101



ERGONOMIC
AA-00102



No7
AA-00103

INSTRUMENTS



SURGICAL HANDLES

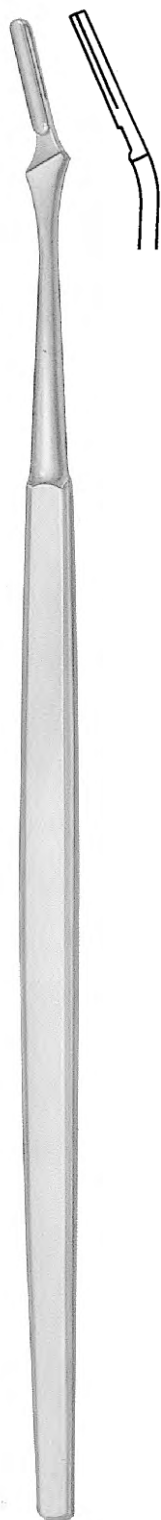

AA-00104



AA-00105



AA-00106



SURGICAL HANDLES



No4
AA-00107



No9
AA-00108



No3
AA-00109



SURGICAL HANDLES



No4L
AA-00110



No10
AA-00111



BARRON
AA-00112
For "BP" type blades
for use with No's 10,11,12 & 15 blades
135mm (5 1/4")





STERILE BLADES



AA-00113



AA-00114



AA-00115



AA-00116



AA-00117



AA-00118



AA-00119



AA-00120



AA-00121

INSTRUMENTS



STERILE BLADES



AA-00122

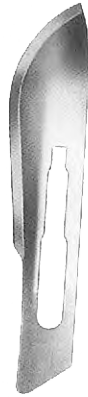

AA-00123



AA-00124



AA-00125



AA-00126



AA-00127



AA-00128

All Blades are sold in dispenser packs of 100
Sterile



SKIN GRAFTING KNIVES



SILVER
AA-00129
Skin Graft Knife
without blade
190mm (7 1/2")

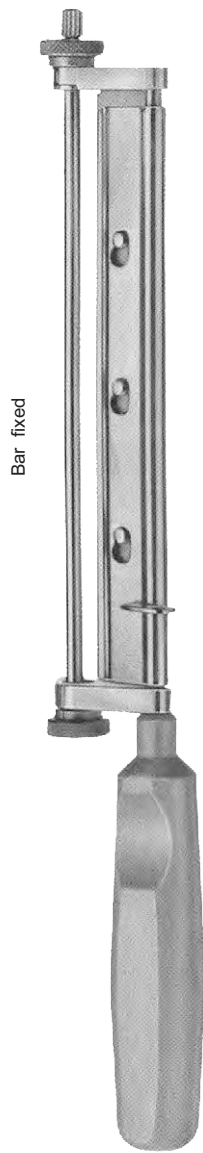

WATSON
AA-00130
Skin Graft Knife
without blade
300mm (12")

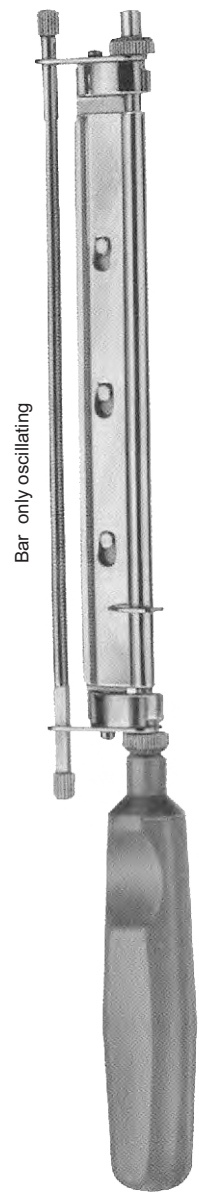

COBBETT
AA-00131
Skin Graft Knife
without blade
315mm (12 2/3")

INSTRUMENTS

SKIN GRAFTING KNIVES



Bar oscillating and rotating



BRAITHWAITE

AA-00132
Skin Graft Knife
without blade
315mm (122/3")

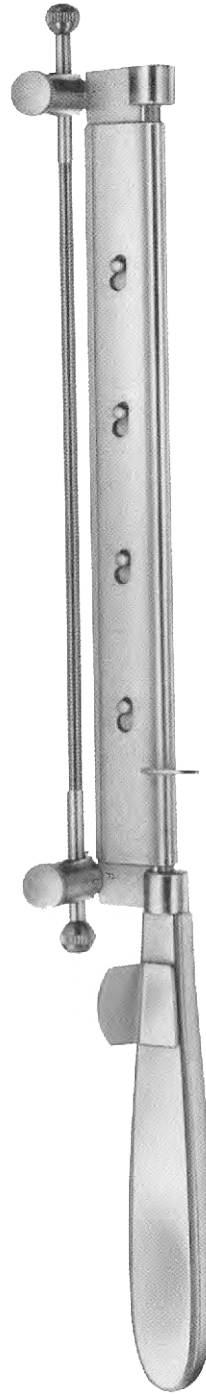

HUMBY

AA-00133
Skin Graft Knife
without blade
365mm (133/4")



SCISSORS



MAYO
Straight, bevelled blades



AD-01100
140 mm
(5 1/2")

AD-01102
190 mm
(7 1/2")



AD-01101
170 mm
(6 3/4")

AD-01103
215 mm
(8 1/2")



AD-01104
140 mm
(5 1/2")

AD-01106
190 mm
(7 1/2")



AD-01105
170 mm
(6 3/4")

AD-01107
215 mm
(8 1/2")

Curved on flat, bevelled blades



MAYO
Round Blades



AD-01108
170 mm
(6 3/4")

200mm
(8")
Straight



AD-01109
140mm
(5 1/2")

150 mm
(6")
Straight



MAYO
Round Blades



AD-01110
170 mm
(6 3/4")

200mm
(8")
Curved on flat



AD-01111
140mm
(5 1/2")

150 mm
(6")
Curved on flat

INSTRUMENTS



SCISSORS

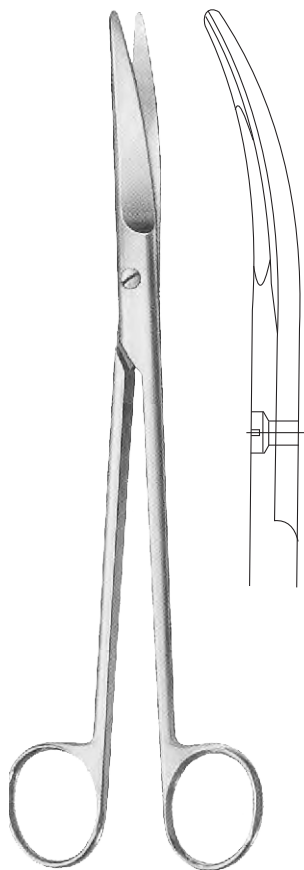

MAYO HARRINGTON
AD-01112
225mm (9")
Curved on flat , blunt points

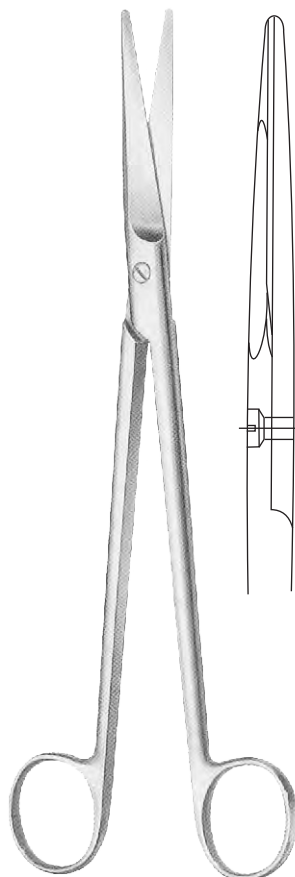

MAYO HARRINGTON
AD-01113
225mm (9")
Straight, blunt points

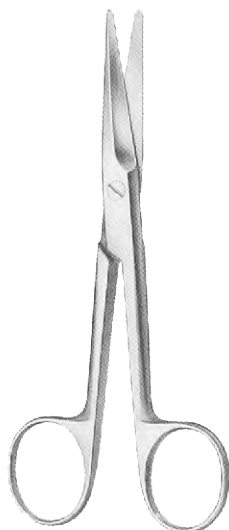

MAYO (STILLE)

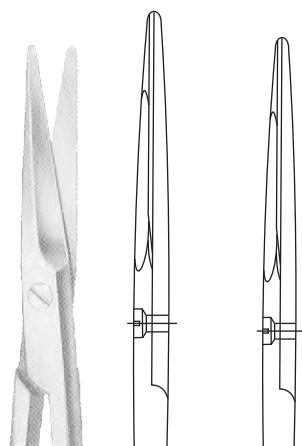

AD-01114 170 mm (6 3/4")
Straight
AD-01115 150 mm (6")
Straight

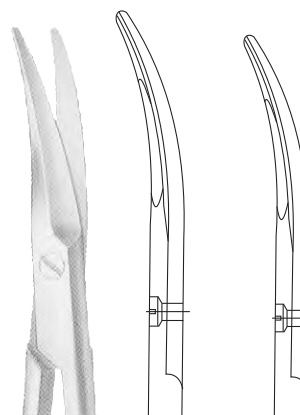

AD-01116 170 mm (6 3/4")
Curved on flate
AD-01117 150 mm (6")
Curved on flate





SCISSORS



METZENBAUM

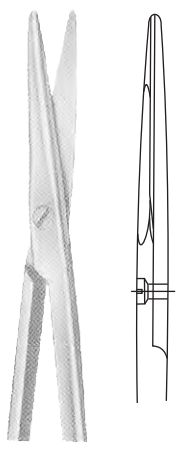

METZENBAUM
Straight, blunt points

- AD-01118**
115mm (4 1/2")
- AD-01119**
145mm (5 3/4")
- AD-01120**
180mm (7")
- AD-01121**
200mm (8")

METZENBAUM (Nelson)
Straight

- AD-01122**
230mm (9")
- AD-01123**
250mm (10")

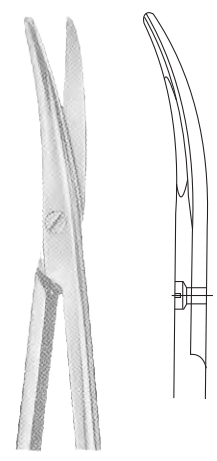

METZENBAUM
Curved on flat, blunt points

- AD-01124**
115mm (4 1/2")
- AD-01125**
145mm (5 3/4")
- AD-01126**
180mm (7")
- AD-01127**
200mm (8")

METZENBAUM (Nelson)
Curved on flat

- AD-01128**
230mm (9")
- AD-01129**
250mm (10")



SCISSORS

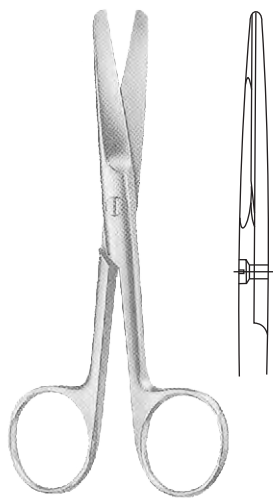

DRESSING
Straight, blunt / blunt points

AD-01134
125mm (5")

AD-01135
145mm (5 3/4")

AD-01136
150mm (6")

AD-01137
180mm (7")

AD-01138
200mm (8")

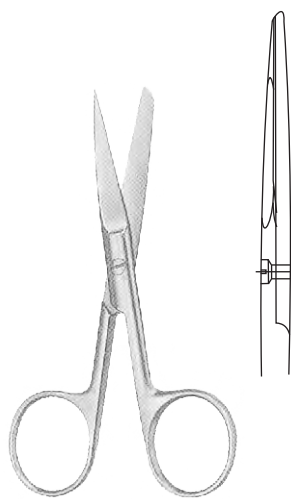

DRESSING
Straight, sharp / blunt points

AD-01139
125mm (5")

AD-01140
145mm (5 3/4")

AD-01141
150mm (6")

AD-01142
180mm (7")

AD-01143
200mm (8")

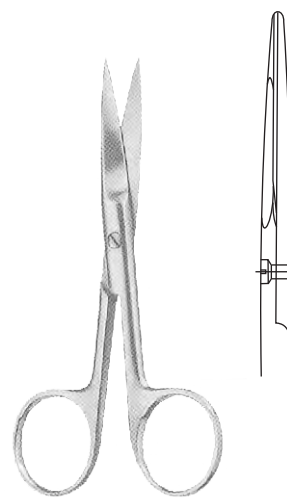

DRESSING
Straight, sharp / Sharp points

AD-01144
125mm (5")

AD-01145
145mm (5 3/4")

AD-01146
150mm (6")

AD-01147
180mm (7")

AD-01148
200mm (8")



SCISSORS

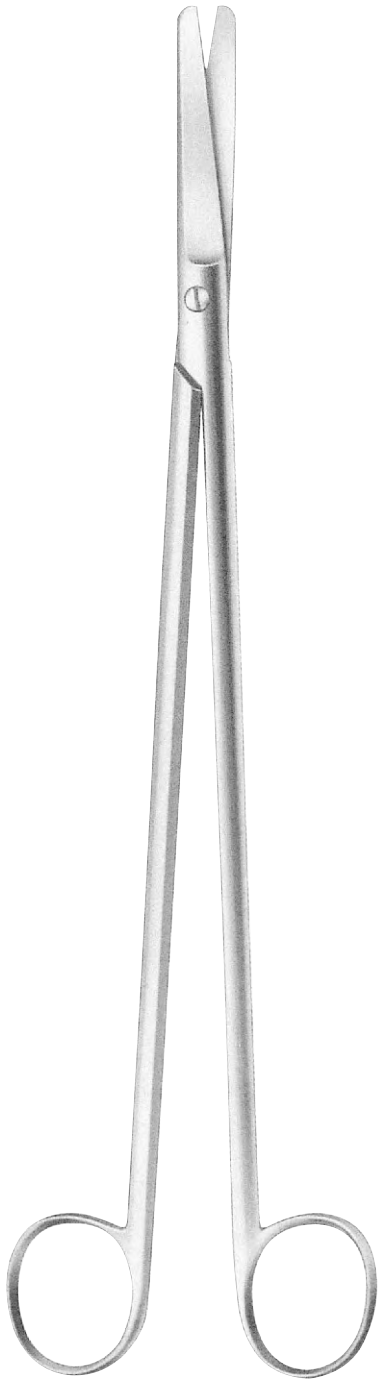

CRAFOORD
AD-01149
305mm (12")
Straight

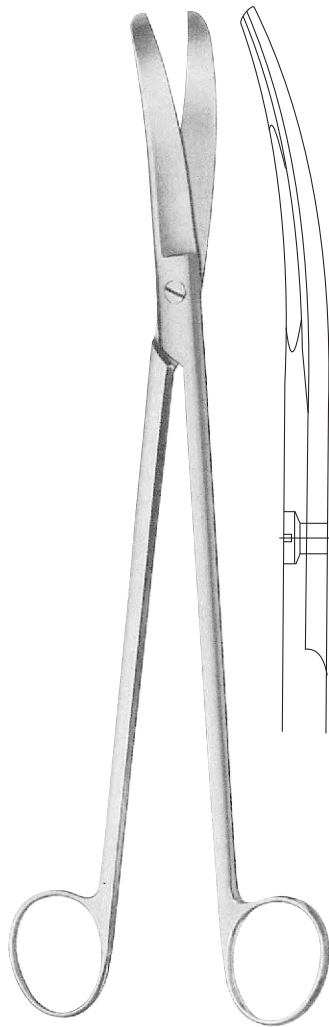

LLOYD DAVIS RECTAL
blunt points, flat blades
AD-01150
255mm (10")
Curved on flat
AD-01151
255mm (10")
Straight

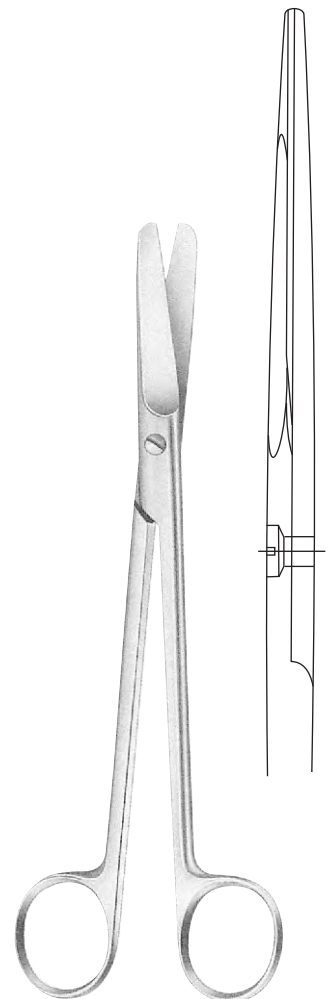

UTERINE
AD-01152
230mm (9")
Straight blunt points



SCISSORS

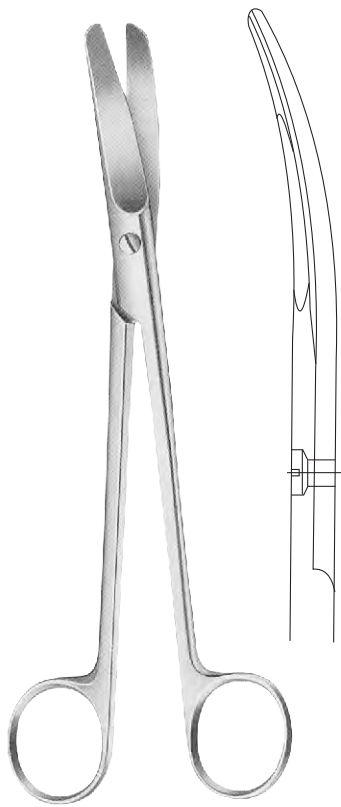

UTERINE
Curved on flat, blunt points

AD-01153
200mm (8")

AD-01154
230mm (9")



**BRAUN STADTLER
EPISIOTOMY**
Angled blades

AD-01155
145mm (53/4)

AD-01156
200mm (8")



**AMERICAN PATTERN
UMBILICAL**
Angled blades

AD-01157
100mm (4")





SCISSORS

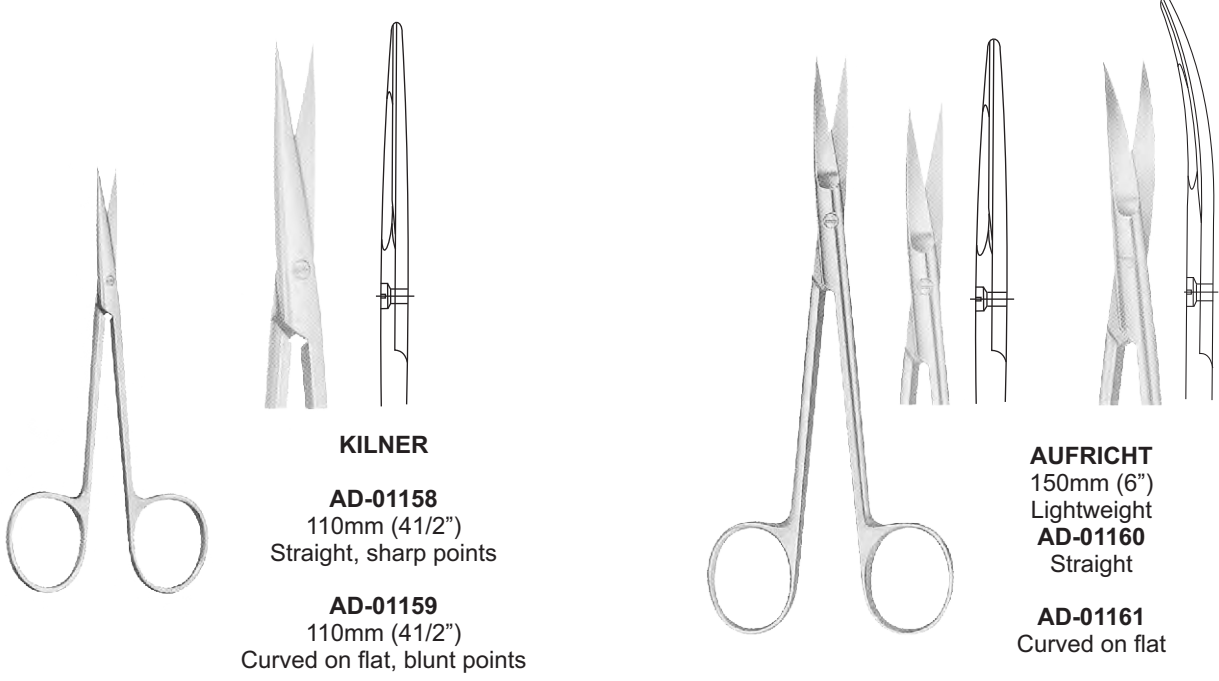

KILNER

AD-01158
110mm (4 1/2")
Straight, sharp points

AD-01159
110mm (4 1/2")
Curved on flat, blunt points

AUFRICHT
150mm (6")
Lightweight
AD-01160
Straight

AD-01161
Curved on flat

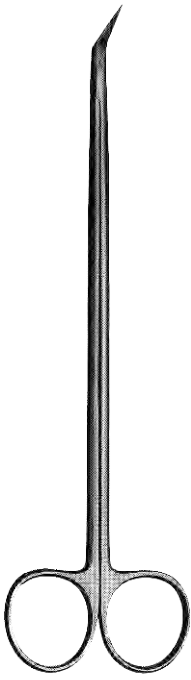

HEGEMANN'S DELICATE
190mm (7 1/2")

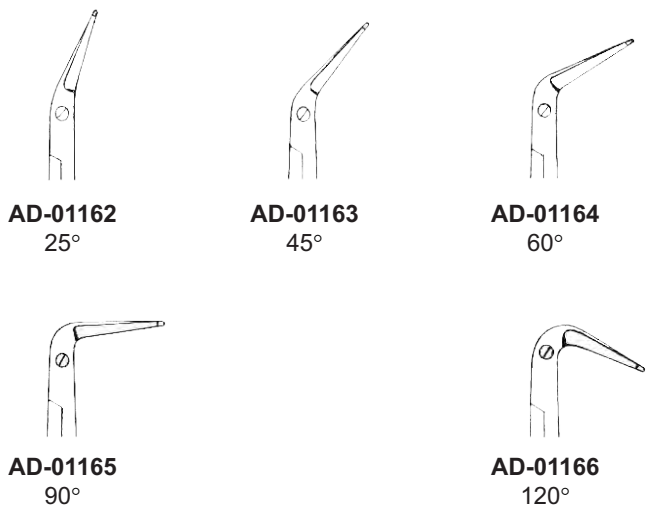

AD-01162
25°

AD-01163
45°

AD-01164
60°

AD-01165
90°

AD-01166
120°

DELICATE SCISSORS

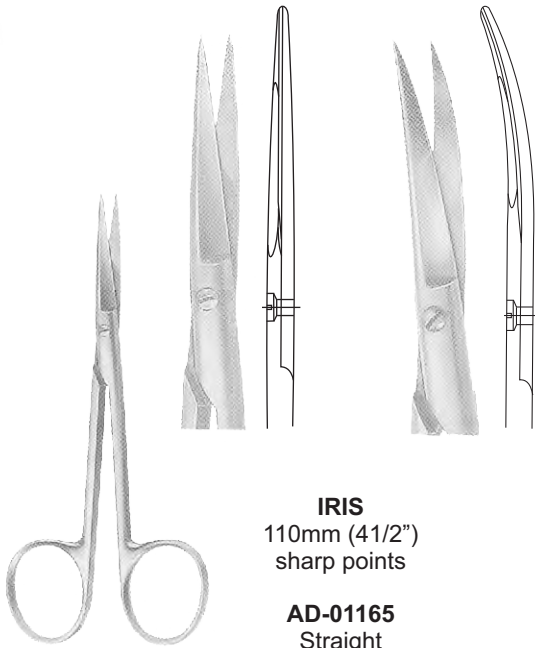

IRIS
110mm (4 1/2")
sharp points

AD-01165
Straight

AD-01166
Curved on flat

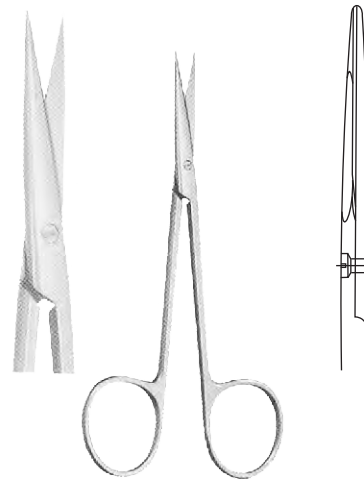

IRIS
110mm (4 1/2")
Round blades, sharp points

AD-01167
Straight

AD-01168
Curved on flat

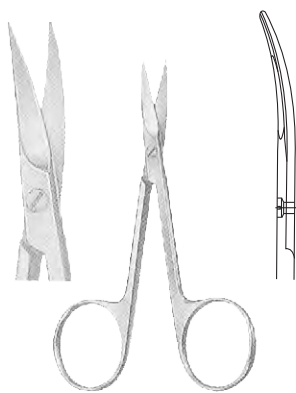

IRIS

AD-01169
90mm (3 1/2")
Curved on flat, lightweight
sharp points

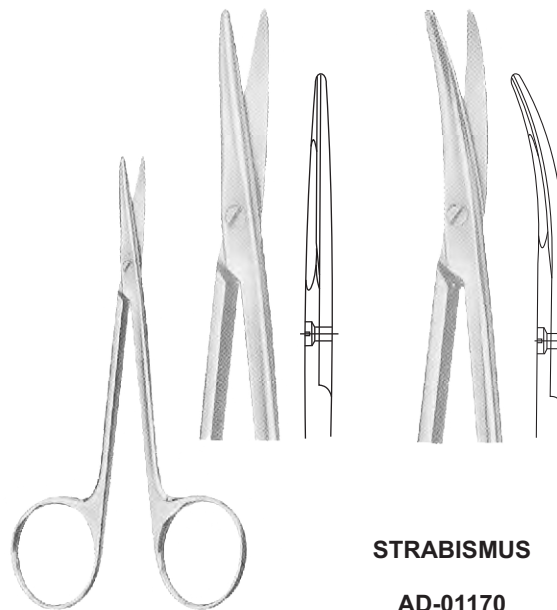

STRABISMUS

AD-01170
110mm (4 1/2")
Straight

AD-01171
110mm (4 1/2")
Curved on flat



DELICATE SCISSORS



**HEYMANN
TURBINECTOMY**

AD-01172
185mm (7 1/4")
Angled shanks
blunt points



STEVENS TENOTOMY
110 mm (4 1/4")

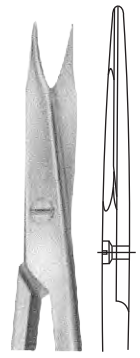

AD-01173
straight,
sharp points

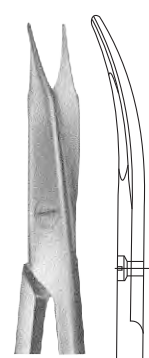

AD-01174
Curved on flat
sharp points

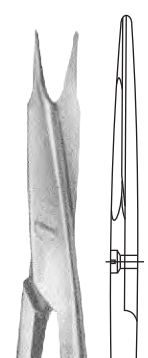

AD-01175
straight,
blunt points



AD-01176
Curved on flat
blunt points

INSTRUMENTS



ORAL SCISSORS

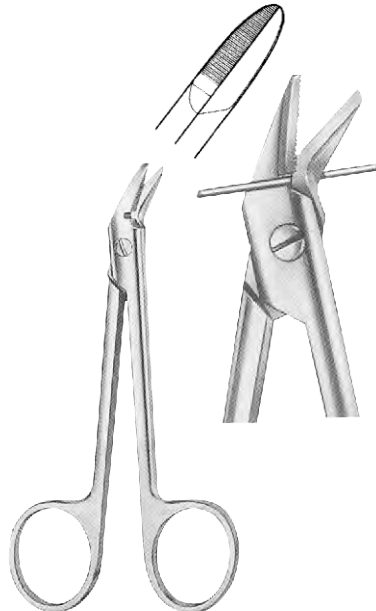

**SCHUKNECHT
WIRE CUTTING**

AD-01177
125mm (5")



WOODS TONSIL

AD-01178
190mm (7 1/2")
Curved on flat
sharpened
outer edge, blunt

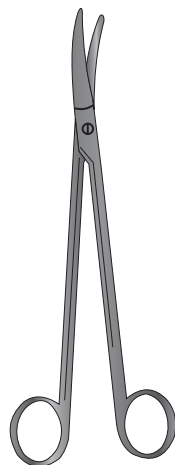

WHEELER TONSIL

AD-01179
200mm (8")
Curved on flat

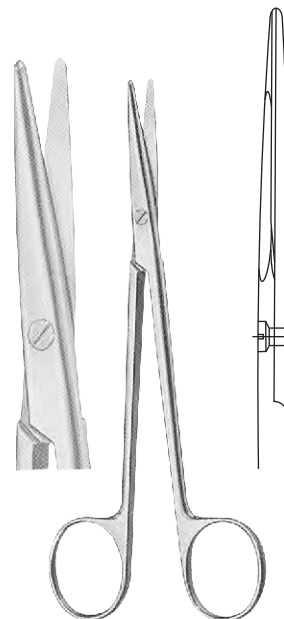

WILSON TONSIL

AD-01180
180mm (7")
Straight



SCISSORS



POTTS

- AD-01186**
190mm (7 1/2")
Angled on flat 45 degrees
- AD-01187**
190mm (7 1/2")
Angled on side 25 degrees
- AD-01188**
190mm (7 1/2")
Angled on side 45 degrees

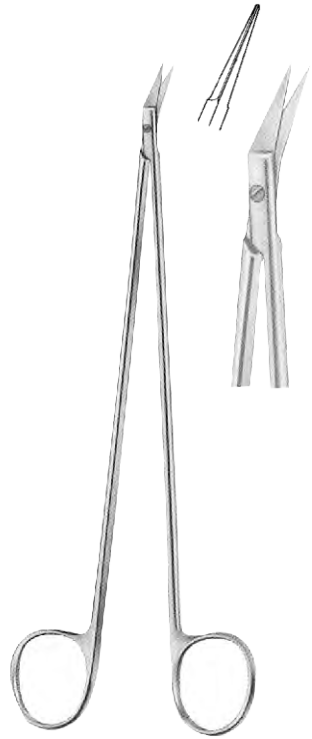

HEDGEMAN (DIETRICH)

- AD-01189**
175mm (7")
Angled to side, 25 degrees
- AD-01190**
175mm (7")
Angled to side, 45 degrees
- AD-01191**
175mm (7")
Angled to side, 60 degrees
- AD-01192**
175mm (7")
Angled to side, 90 degrees
- AD-01193**
175mm (7")
Angled to side, 125 degrees



FAVALORO

- AD-01194**
150mm (6")
Shanks curved,
blades angled to side



SCISSORS

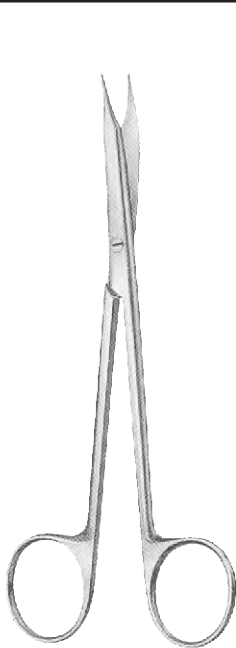

REYNOLDS
Curved on flat, tapered points

AD-01195
145mm (5³/₄")

AD-01196
180mm (7")

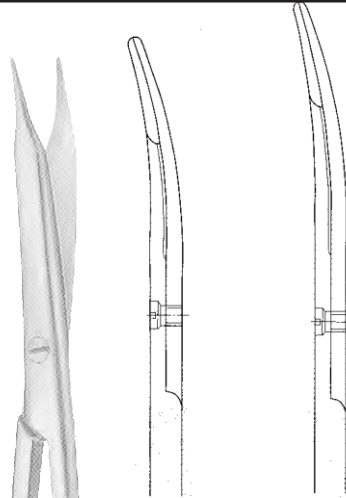

DOYEN ABDOMINAL

AD-01197
180mm (7")
Curved, blunt points

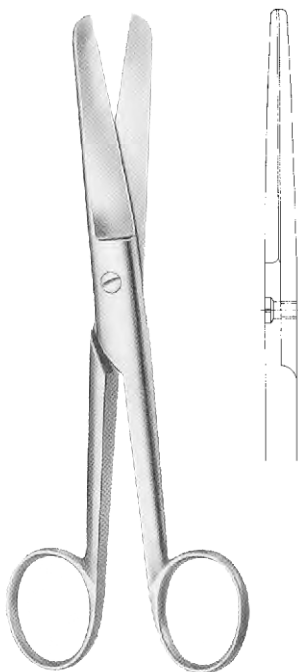

DOYEN ABDOMINAL

AD-01198
180mm (7")
Straight, blunt points

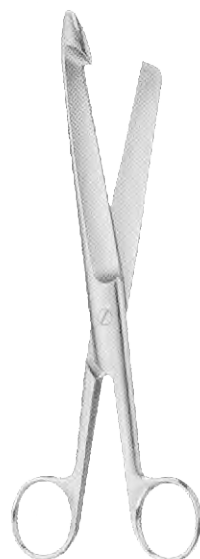

DOYEN ABDOMINAL

AD-01199
210mm (8¹/₄")
One blade with hook end



COUNTER SCISSORS

AD-01200
210mm (8¹/₄")





SCISSORS

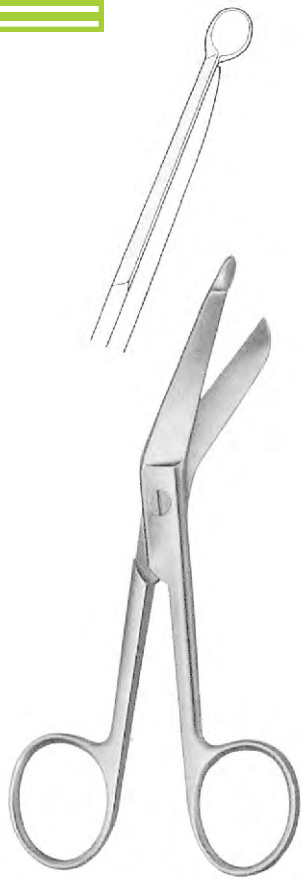

LISTER BANDAGE

- AD-01201**
115mm (4 1/2")
- AD-01202**
140mm (5 1/2")
- AD-01203**
180mm (7")
- AD-01204**
200mm (8")
- AD-01205**
235mm (9 1/4")



SCHUMACHER UMBILICAL

AD-01206
155mm (6")

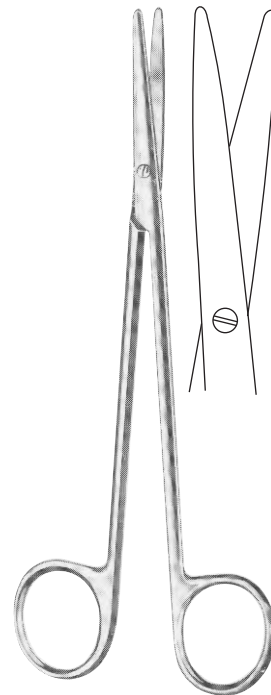

MCINDOE SCISSORS

AD-01207
180mm (7")
Straight

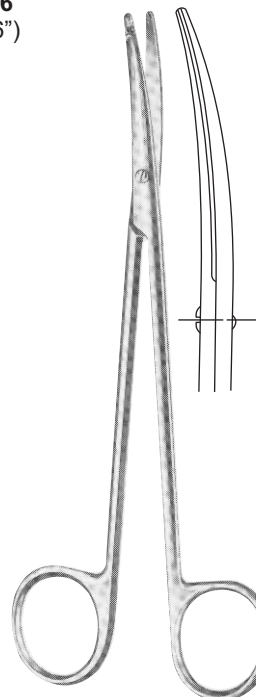

MCINDOE SCISSORS

B14-01208
180mm (7")
Curved



“TC” SCISSORS

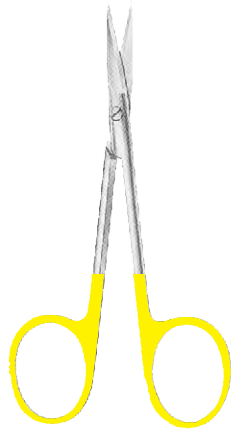

IRIS SCISSORS
110mm (43/8")



AD-01300



AD-01301

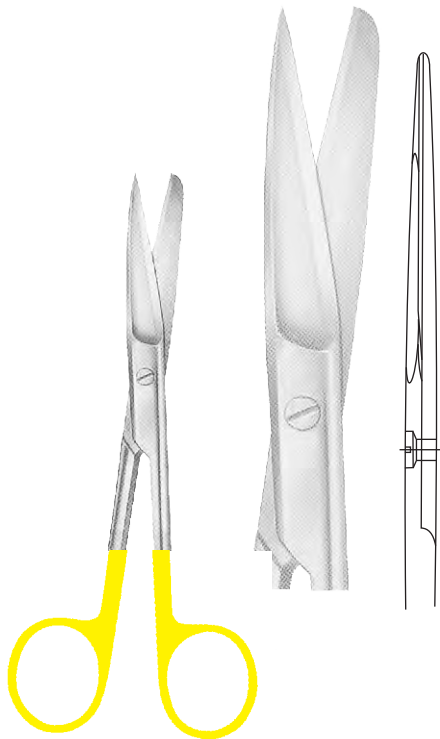

SURGICAL SCISSORS

- AD-01302**
- 130mm (5")
- 150mm (6")
- 180mm (7")

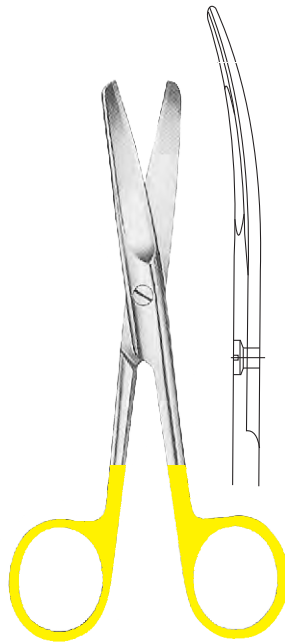
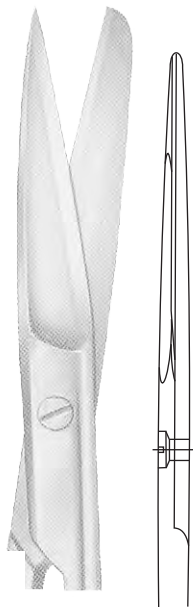

SURGICAL SCISSORS

- AD-01303**
- 130mm (5")
- 150mm (6")
- 180mm (7")



SURGICAL SCISSORS

- AD-01304**
- 130mm (5")
- 150mm (6")
- 180mm (7")





“TC” SCISSORS

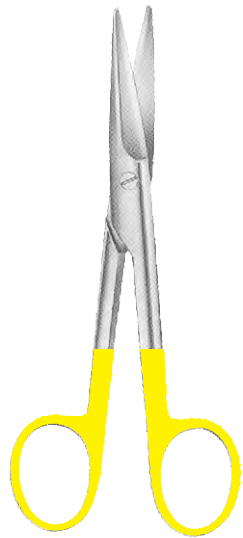

**MAYO
DISSECTING
SCISSORS**

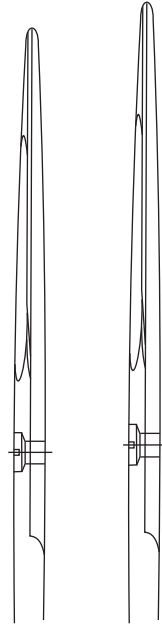

AD-01305
140mm (5 1/2")
150mm (6")
180mm (7")
200mm (8")
230mm (9")



AD-01306
140mm (5 1/2")
150mm (6")
180mm (7")
200mm (8")
230mm (9")

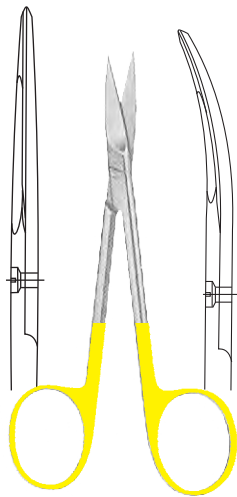

DELICATE SCISSORS
120mm (4 3/4")

AD-01307 Straight

AD-01308 Curved

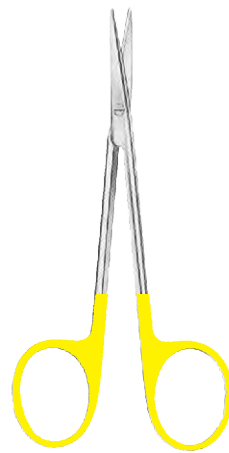

STRABISMUS SCISSORS
115mm (4 1/2")

AD-01309 Straight

AD-01310 Curved

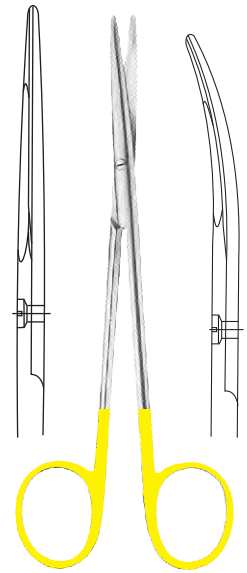

BABY METZANBAUM
145mm (5, 3/4")

AD-01311 Straight

AD-01312 Curved



“TC” SCISSORS

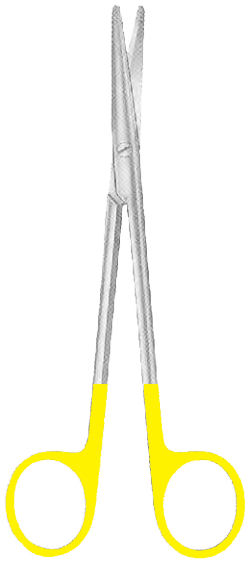

METZENBAUM
Round Blade Straight



AD-01313
180mm (7")



AD-01314
145mm (53/4")



AD-01315
180mm (7")



AD-01316
200mm (8")



AD-01317
145mm (53/4")

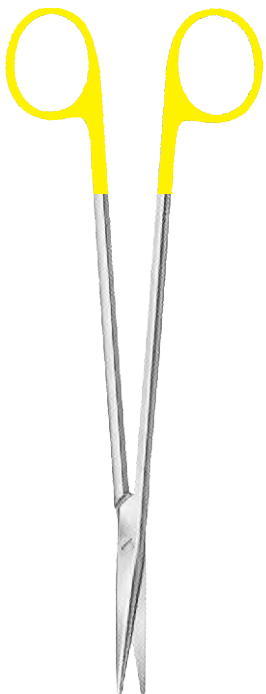

AD-01318
180mm (7")



AD-01319
200mm (8")



AD-01320
230mm (9")



AD-01321
180mm (7")



AD-01322
200mm (8")



AD-01323
230mm (9")



“TC” SCISSORS

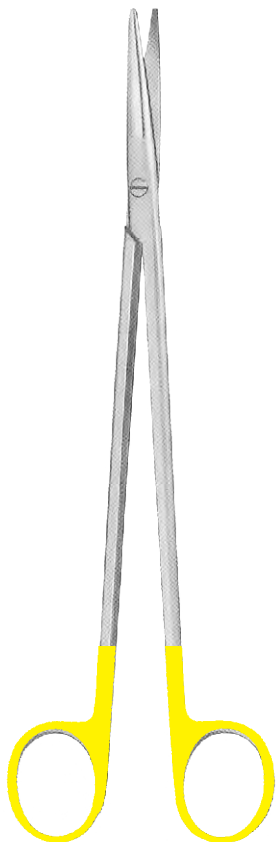

NELSON-METZENBAUM
Straight

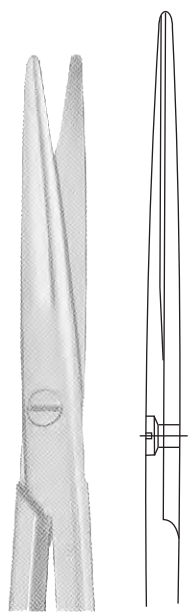

AD-01324
230mm (9")
300mm (12")

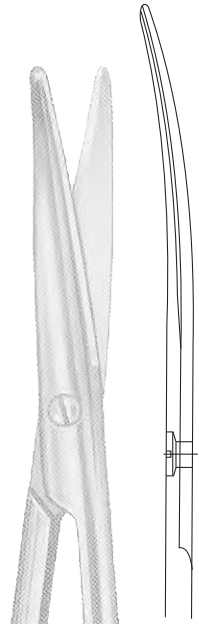

AD-01325
230mm (9")
Curved



AD-01326
300mm (12")

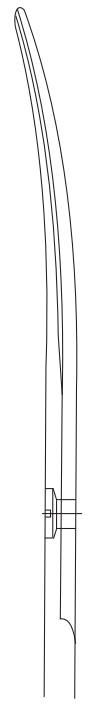

AD-01327
230mm (9")
Broad blade end

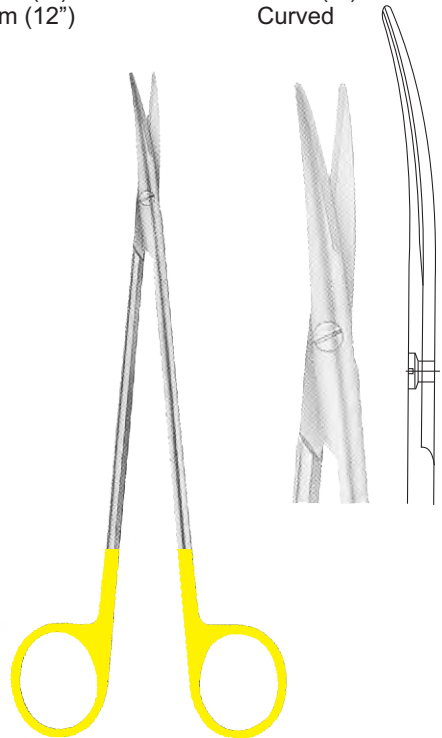

TOENNIS - ADSON
Curved
AD-01328
175mm (7")

Email: adas.surgical@gmail.com / www.adasinstruments.net / whatsapp / viber : 0092 321 612 6625



"TC" SCISSORS

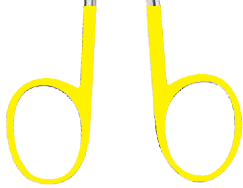
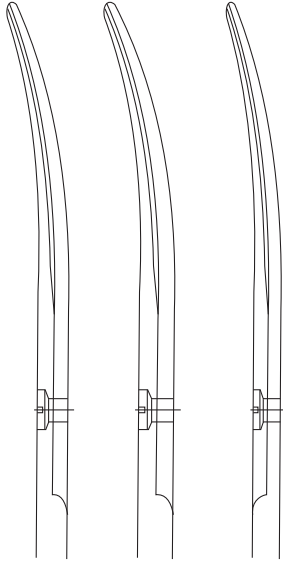

NELSON - METZENBAUM

AD-01329
260mm (10 1/4")

AD-01330
280mm (11")

AD-01331
285mm (11 1/4")

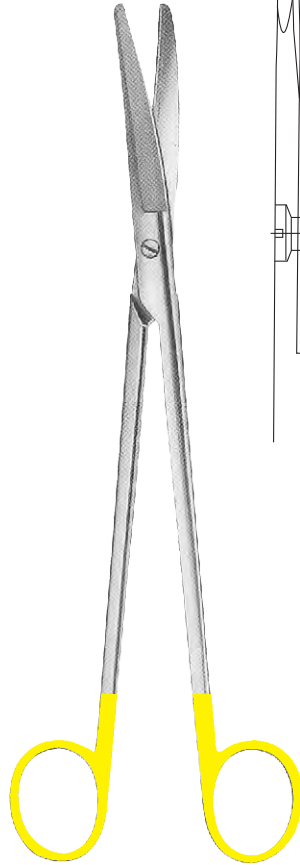

NELSON - METZENBAUM
Dissecting Scissors

AD-01332
230mm (9")

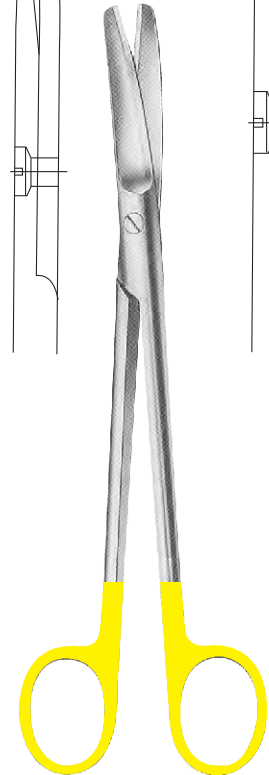
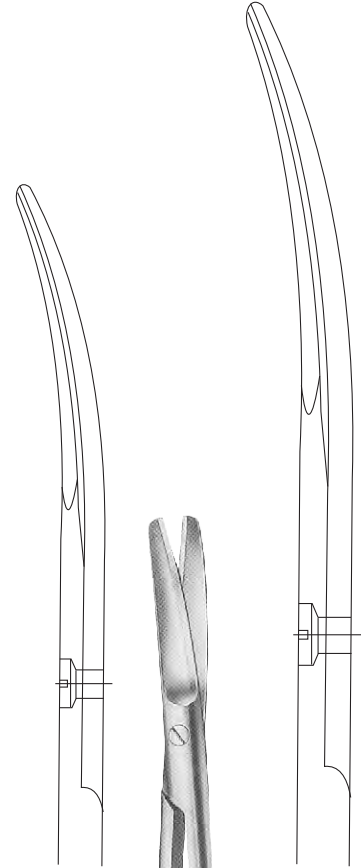

SIMS

AD-01333
200mm (8")

AD-01334
230mm (9")





“TC” SCISSORS

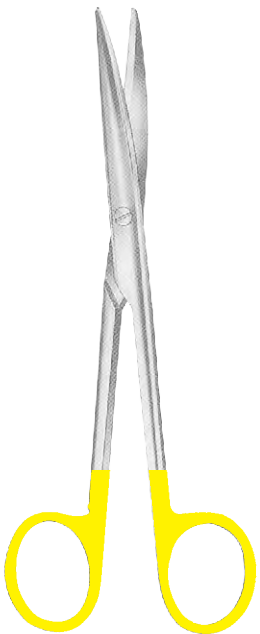

LEXER

AD-01335
165mm (6 1/2")

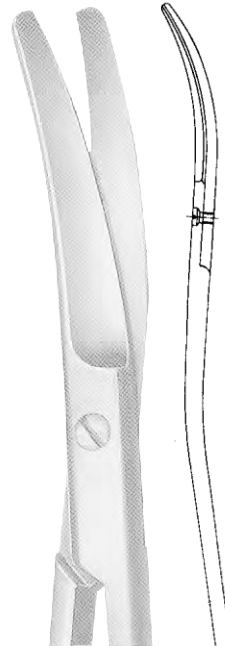
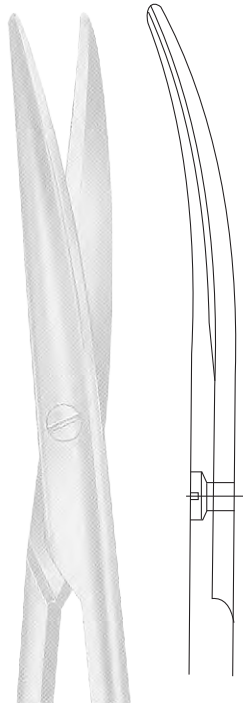

HYSTERECTOMY SCISSORS

AD-01336
250mm (10")



HYSTERECTOMY SCISSORS

AD-01337
250mm (10")

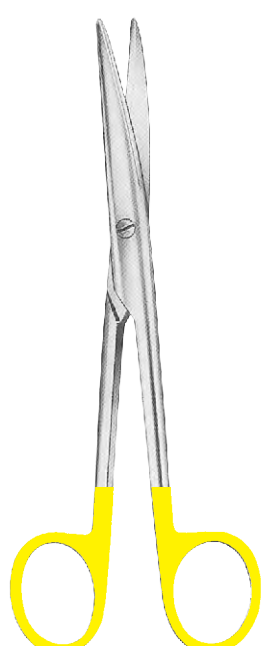

MAYO-LEXER

AD-01338
165mm (6 1/2")

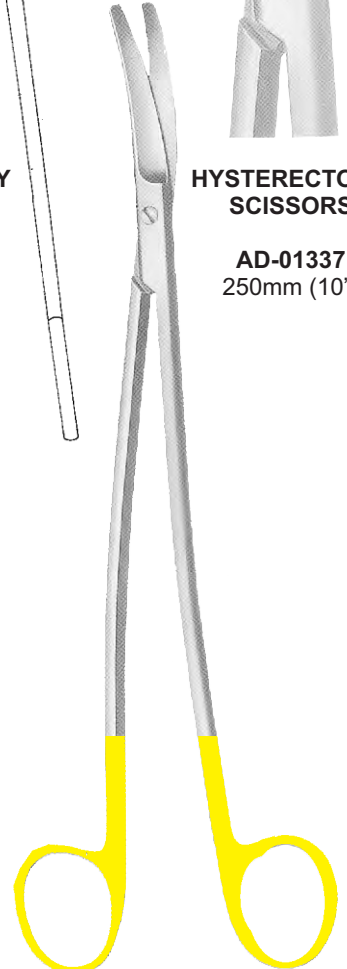
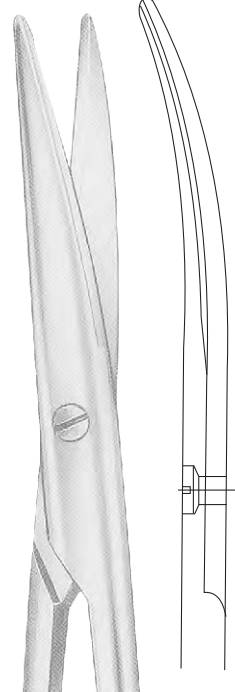

HYSTERECTOMY SCISSORS
Strongly curved to fit with parametriumclamps

INSTRUMENTS



"TC" SCISSORS

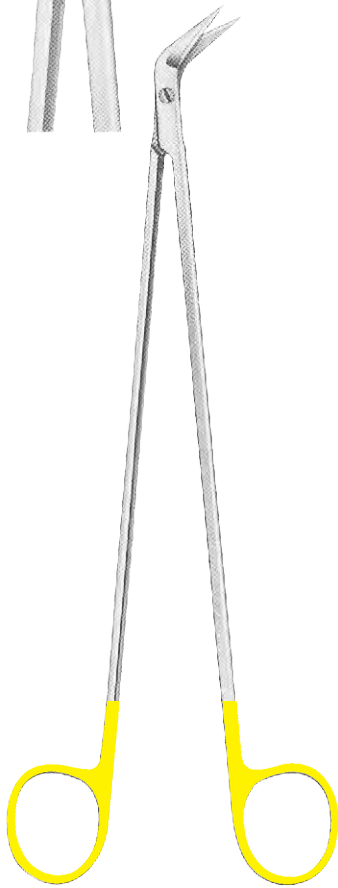
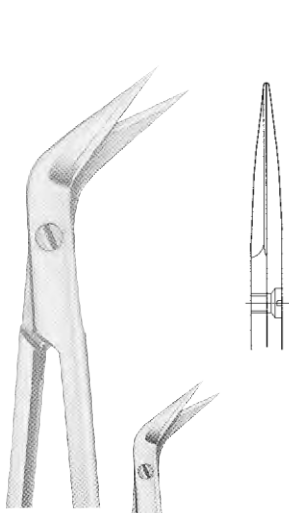

**DEBAKEY
VASCULAR SCISSORS**

AD-01341
220mm (83/4")

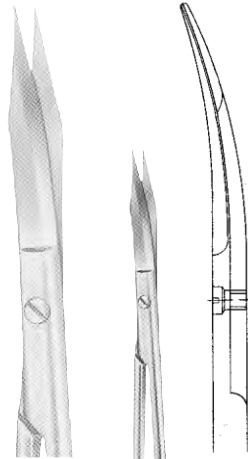

AD-01339
Sharp Point
130mm (51/8")
1 blad serrated

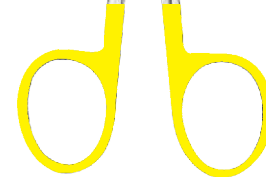
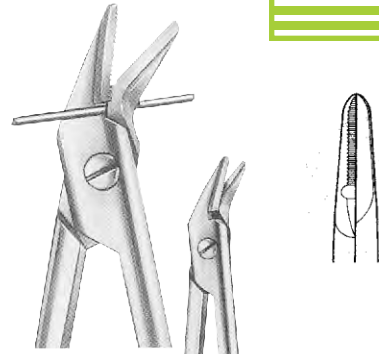

AD-01340
120mm (43/4")
Wire cutting scissors
1 blade serrated

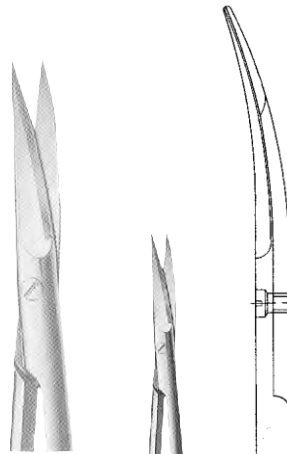

IRIS DELICATE

AD-01342
110mm (43/8")

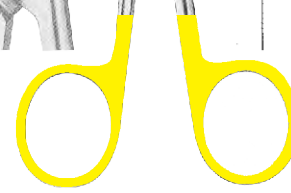
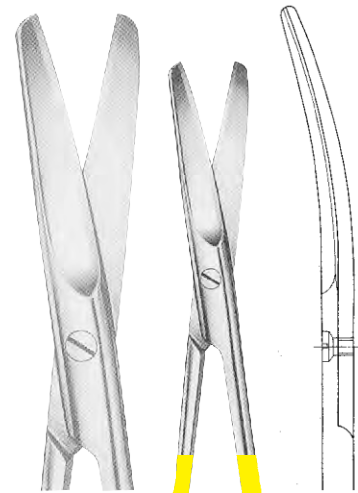

DRESSING SCISSORS

AD-01343
145mm (53/4")





"TC" SCISSORS

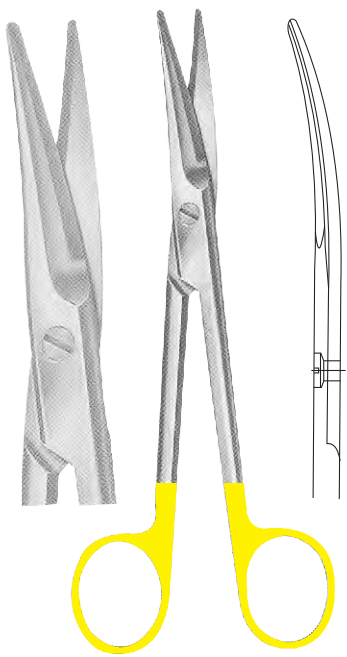

MAYO

AD-01344
170mm (63/4")
Dissecting Scissors

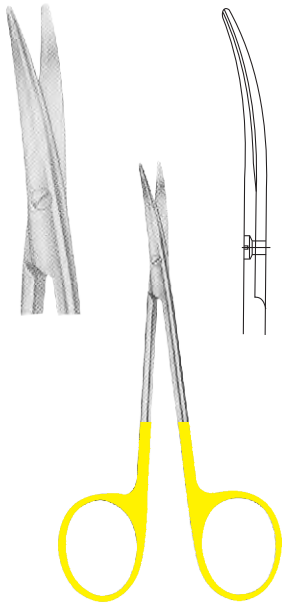

METZENBAUM DELICATE

AD-01345
115mm (4 1/2")

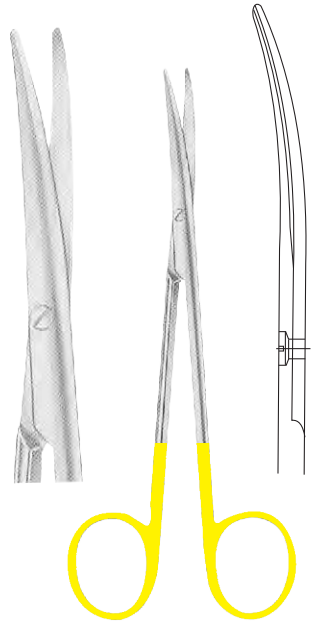

BABY METZENBAUM

AD-01346
145mm (5 3/4")
180mm (7")
200mm (8")



METZENBAUM

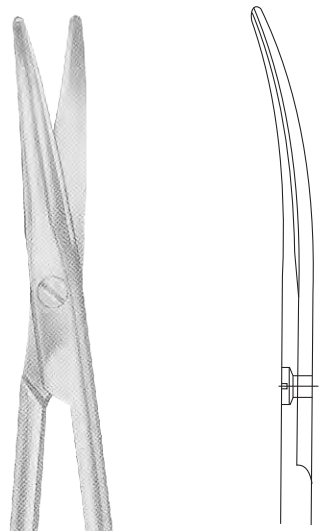

AD-01347
145mm (5 3/4")



AD-01348
180mm (7")

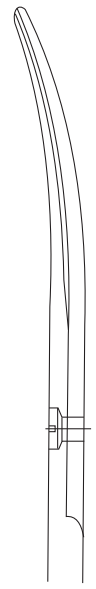

AD-01349
200mm (8")

INSTRUMENTS



"TC" SCISSORS

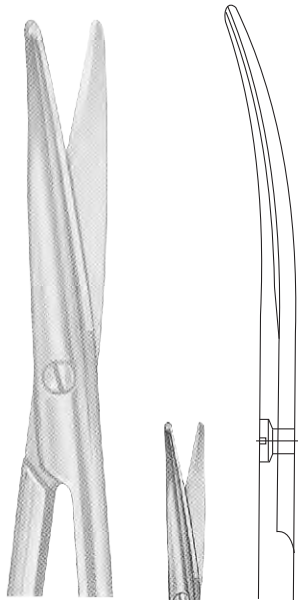

METZENBAUM

AD-01350
180mm
(7")

AD-01351
200mm
(8")

AD-01352
230mm
(9")

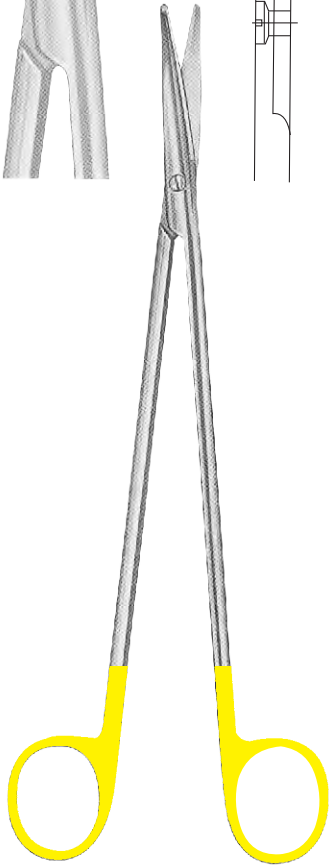

NELSON-METZENBAUM

AD-01353
230mm (9")

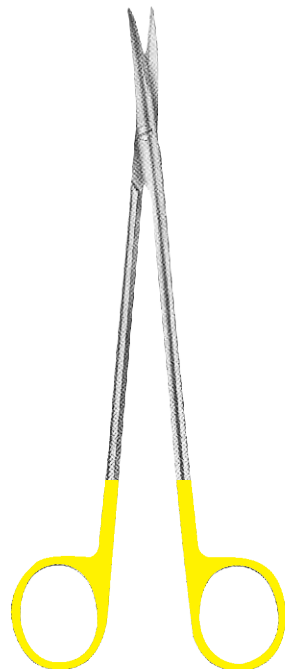

TOENNIS ADSON



AD-01354
175mm (7")



“TC” SCISSORS

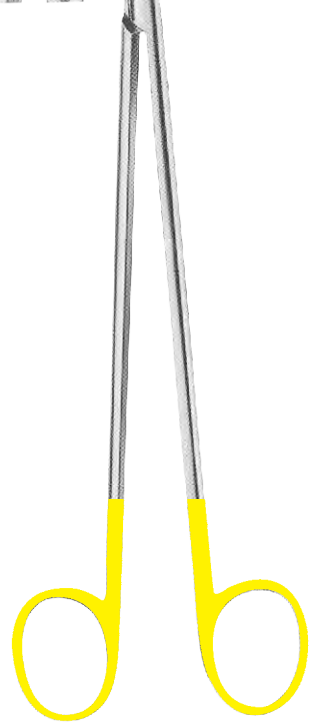

NELSON-METZENBAUM
AD-01355
260mm (10 1/4")
AD-01356
280mm (11")

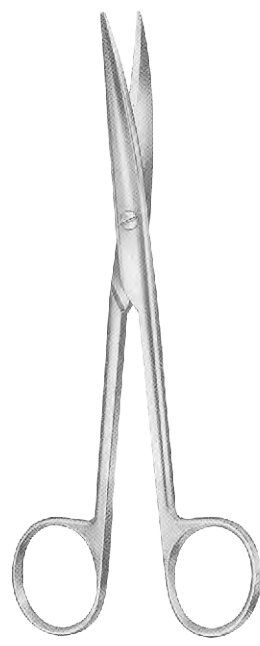

LEXER
Straight
AD-01357
165mm (6 1/2")



MAYO - LEXER
Curved
AD-01358
165mm (6 1/2")

INSTRUMENTS



"TC" SCISSORS

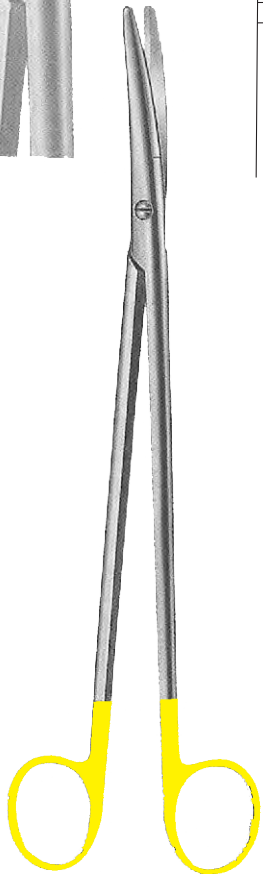
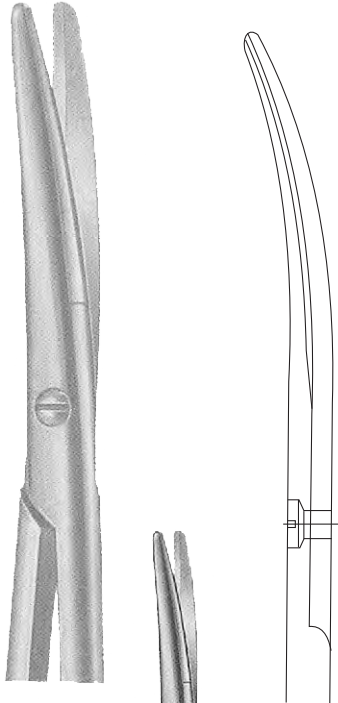

METZENBAUM

AD-01359
230mm (9")
With broad blade ends

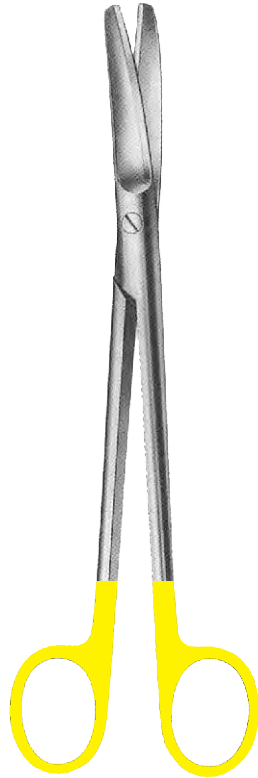

SIMS

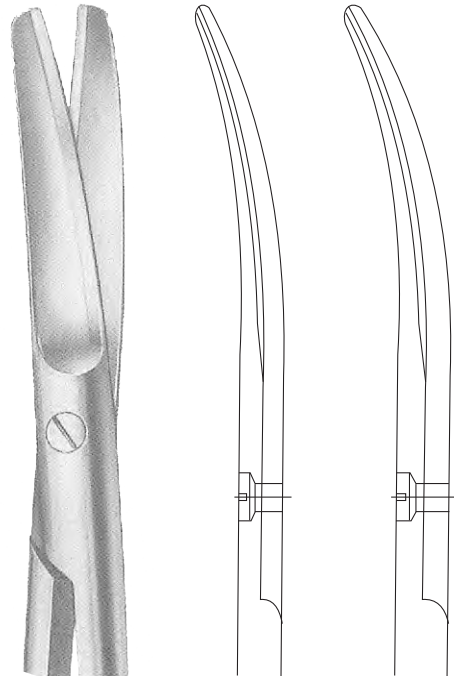

AD-01360 **AD-01361**
200mm (8") 230mm (9")

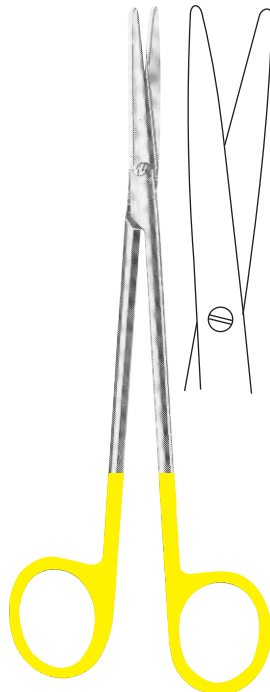

MCINDOE SCISSORS

AD-01362
180mm (7")
Straight

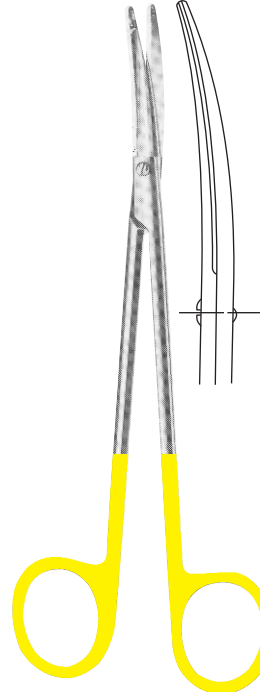

MCINDOE SCISSORS

AD-01363
180mm (7")
Curved





“TC” SCISSORS

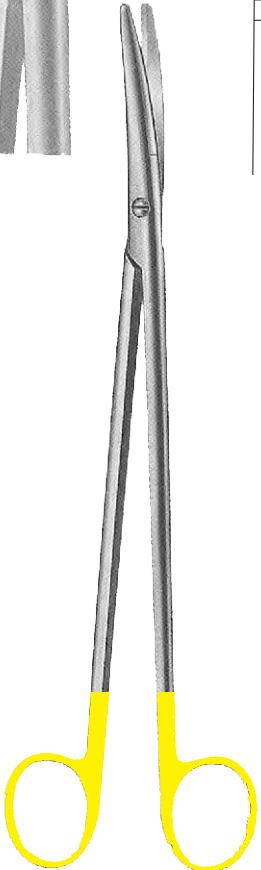
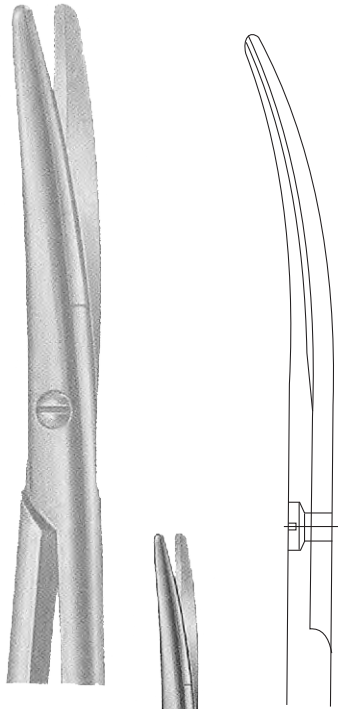

METZENBAUM
AD-01359
230mm (9")
With broad blade ends

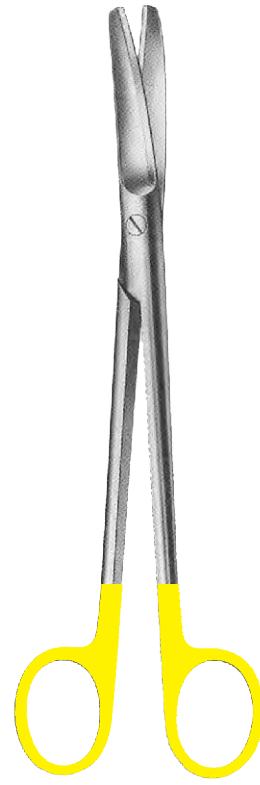
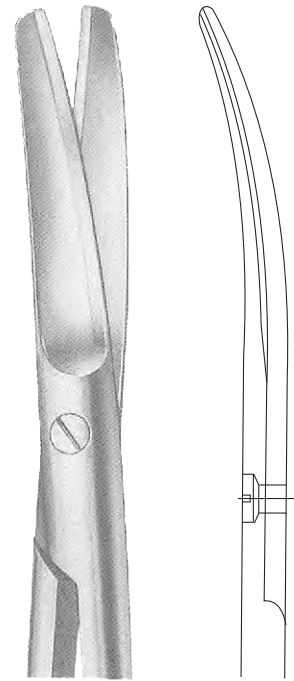

SIMS
AD-01361
200MM (8")

SIMS
AD-01360
230mm (9")

SUPER CUT SCISSORS

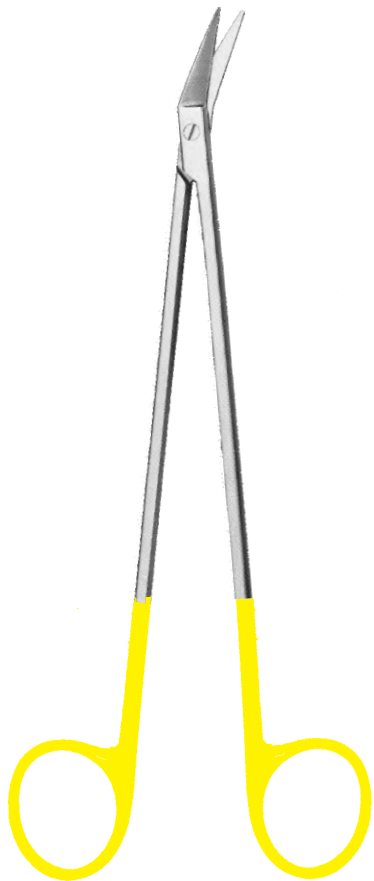

AD-01400

POTT-SMITH SCISSORS
Scissor for Vascular Surgery

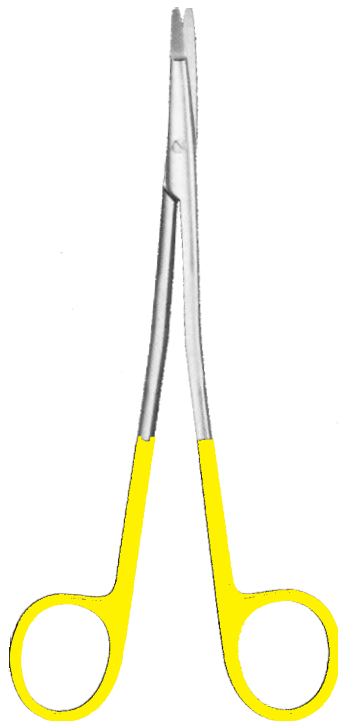

AD-01401

KILNER SCISSORS
Scissor for Plastic Surgery

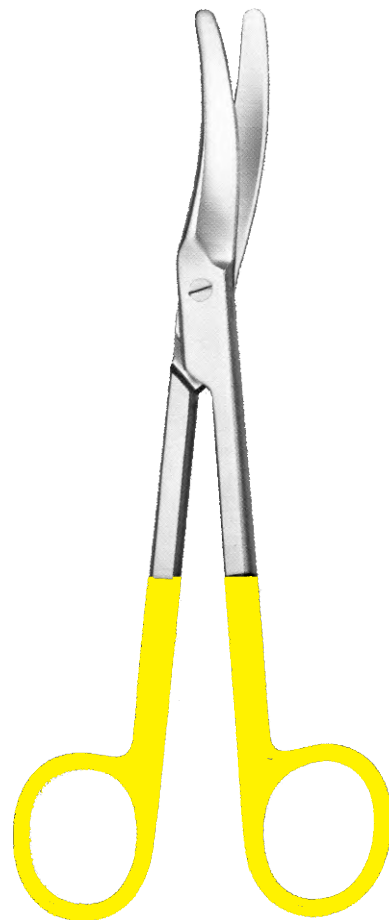

AD-01402



SUPER CUT SCISSORS



AD-01403
REYNOLDS SCISSORS
150mm (6")
180mm (7")

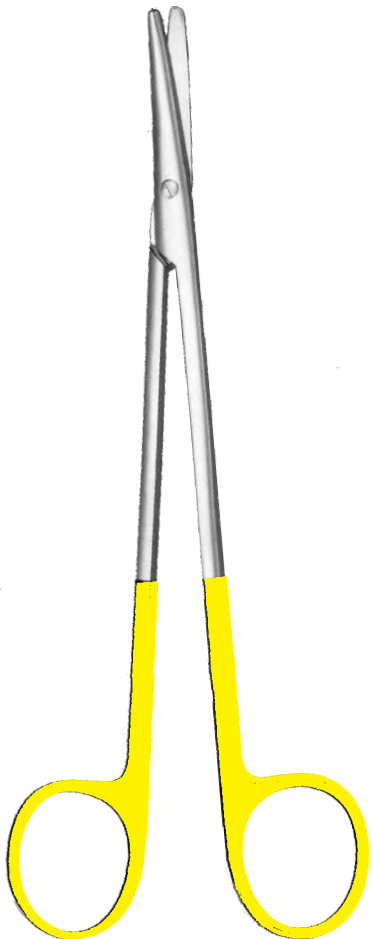

AD-01404
METZENBAUM
Straight
145mm (53/4")
180mm (7")
200mm (8")

Curved
145mm (53/4")
180mm (7")

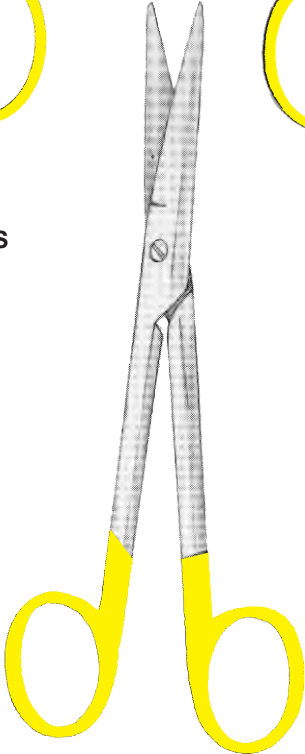

AD-01405
MAYO
140mm (51/2")

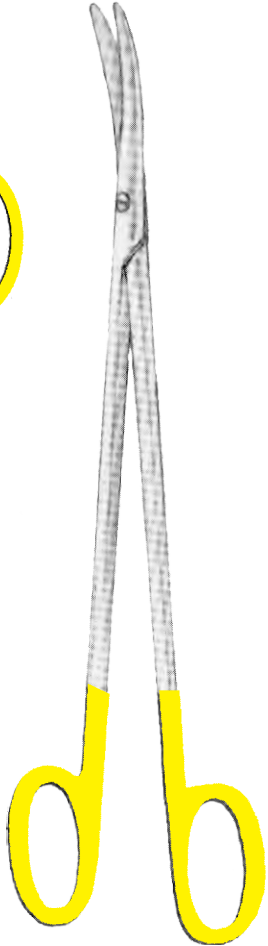

AD-01406
McIndoe
190mm (71/4")

INSTRUMENTS

SERRATED DISSECTING FORCEPS



CANADIAN
Straight

AC-02100
130mm (5 1/8")

AC-02101
150mm (6")



DISSECTING FORCEPS
Turn over end

AC-02102
125mm (5")

AC-02103
150mm (6")

AC-02104
180mm (7")

AC-02105
200mm (8")

AC-02106
250mm (10")



DISSECTING FORCEPS
Block end

AC-02107
125mm (5")

AC-02108
150mm (6")

AC-02109
180mm (7")

AC-02110
200mm (8")

AC-02111
250mm (10")



SERRATED DISSECTING FORCEPS



DISSECTING FORCEPS



AC-02112
115mm
(4 1/2")



AC-02113
130mm
(5 1/8")



AC-02114
145mm
(5 3/4")



AC-02115
160mm
(6 1/4")



AC-02116
305mm
(12")



DISSECTING FORCEPS



AC-02117
150mm
(6")



AC-02118
180mm
(7")



AC-02119
200mm
(8")

INSTRUMENTS

SERRATED DISSECTING FORCEPS



**DISSECTING
FORCEPS**
Round Points



AC-02120
115mm
(4 1/2")



AC-02121
130mm
(5 1/8")



AC-02122
150mm
(6")



AC-02123
160mm
(6 1/4")



AC-02124
180mm
(7")



AC-02125
200mm
(8")



AC-02126
250mm
(10")



AC-02127
300mm
(12")



SERRATED DISSECTING FORCEPS



RAMSEY
AC-02128
180mm (7")



BONNEY
AC-02129
180mm (7")



BICKFORD
AC-02130
225mm (9")

INSTRUMENTS

SERRATED DISSECTING FORCEPS



MAINGOT INTESTINAL
Fenestrated Grip

AC-02131
280mm (11")

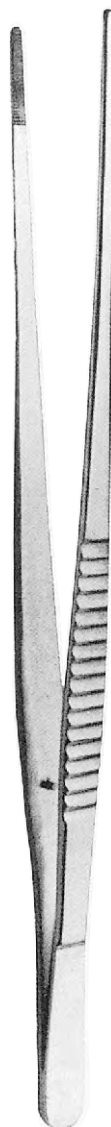

ST MARKS

AC-02132
290mm (11 1/2")

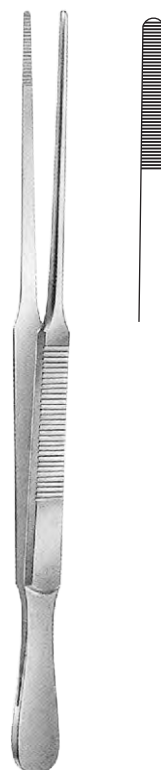













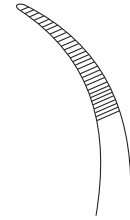
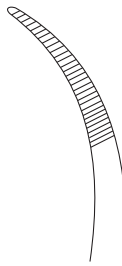

EMMET

AC-02133
200mm (8")



DELICATE DISECTING FORCEPS

					
	AC-02134 90mm (3 1/2")	AC-02136 105mm (4 1/8")	AC-02138 115mm (4 1/2")	AC-02140 130mm (5 1/8")	AC-02142 145mm (5 3/4")
					
	AC-02135 90mm (3 1/2")	AC-02137 105mm (4 1/8")	AC-02139 115mm (4 1/2")	AC-02141 130mm (5 1/8")	AC-02143 145mm (5 3/4")
					
MACINDOE AC-02144 150mm (6")		WAUGH AC-02145 200mm (8")		WAUGH	AC-02146 150mm (6") AC-02147 180mm (7")

INSTRUMENTS

DELICATE DISECTING FORCEPS

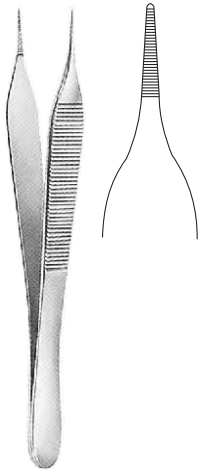

ADSON

AC-02148
125mm (5") Fine

AC-02149
125mm (5") Standard

AC-02150
190mm (7 1/2")



CAIRNS (DOTT)

AC-02151
215mm (8 1/2")
Medium jaw
2mm wide

AC-02152
180mm (7")
Fine jaw
1mm wide



JEFFERSON

AC-02153
180mm (7")

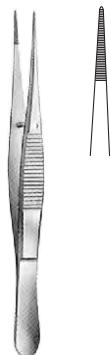

SILCOCK

AC-02154
100mm (4")



EXTRA FINE
100mm (4")

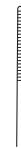

AC-02155



AC-02156



TOOTHED DISSECTING FORCEPS

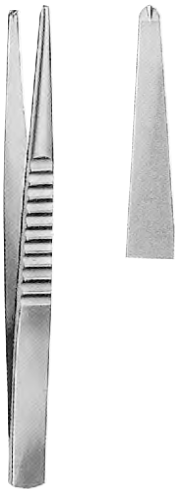

- TREVES**
1 x 2 teeth
- AC-02157**
125mm (5")
- AC-02158**
150mm (6")
- AC-02159**
180mm (7")
- AC-02160**
200mm (8")
- AC-02161**
250mm (10")



- LANE**
1 x 2 teeth
- AC-02162**
125 mm (5")
- AC-02163**
145mm (53/4")
- AC-02164**
180mm (7")
- LANE**
2 x 3 teeth
- AC-02165**
145mm (53/4")
- AC-02166**
180mm (7")



- DISSECTING FORCEPS**
- AC-02167**
150mm (6")
2 x 3 teeth
- AC-02168**
150mm (6")
3 x 4 teeth



TOOTHED DISSECTING FORCEPS



AC-02169
105mm
(4 1/8")

AC-02170
115mm
(4 1/2")

AC-02171
130mm
(5 1/8")

AC-02172
150mm
(6")

AC-02173
160-mm
(6 1/4")

AC-02174
180mm
(7")

AC-02175
200mm
(8")

AC-02176
250mm
(10")

AC-02177
300mm
(12")

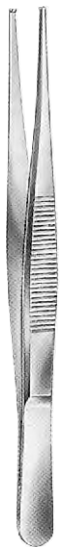

DISSECTING FORCEPS

1 x 2 teeth



AC-02178
115mm
(4 1/2")

AC-02179
130mm
(5 1/8")

AC-02180
145mm
(5 3/4")

AC-02181
160mm
(6 1/4")



GILLIES

AC-02182
150mm (6")
1 x 2 teeth



MICINDOE

AC-02183
150mm (6")
1 x 2 teeth





TOOTHED DISSECTING FORCEPS



WAUGH
1 x 2 teeth
AC-02184
200mm (8")
AC-02185
180mm (7")
AC-02186
150mm (6")



ADSON
1 X 2 teeth
AC-02187
125mm (5") Fine
AC-02188
125mm (5") Standard
AC-02189
190mm (7 1/2")



ADSON
Bayonet
1 x 2 teeth
AC-02190
190mm (7 1/2")



JEFFERSON
1 x 2 teeth
AC-02191
180mm (7")



ADSON-BROWN
7 x 7 teeth
AC-02192
125mm (5")



PENNYBACKER
3 x 4 teeth
AC-02193
160mm (6 1/2")

INSTRUMENTS

TOOTHED DISSECTING FORCEPS

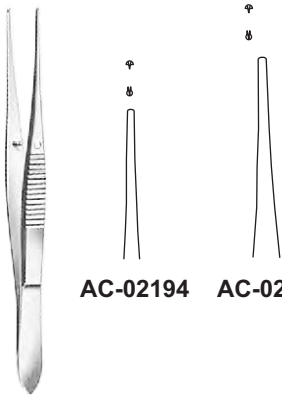

AC-02194 AC-02195

SILCOCK
1 x 2 teeth

AC-02194
100mm (4")
AC-02195
110mm (4 3/8")

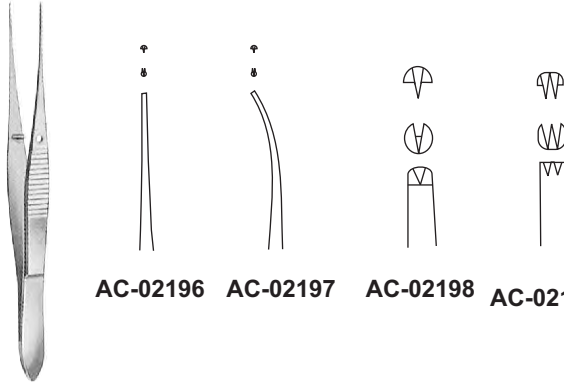

AC-02196 AC-02197 AC-02198 AC-02199

FINE
1 x 2 teeth
AC-02196
100mm (4")
AC-02197
100mm (4")

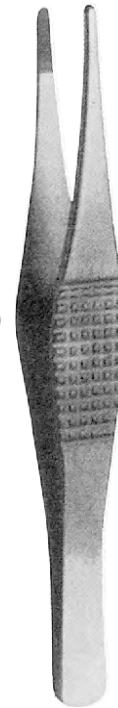

RAMSEY
180mm (7")

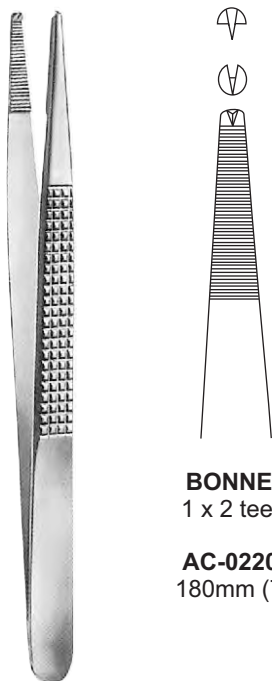

BONNEY
1 x 2 teeth

AC-02200
180mm (7")

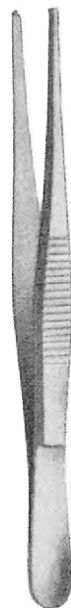

BICKFORD
1 x 2 teeth

AC-02201
225mm (9")



CANADIAN
2 x 3 teeth

AC-02202
140mm (5 1/2")

AC-02203
150mm (6")



TOOTHED DISSECTING FORCEPS

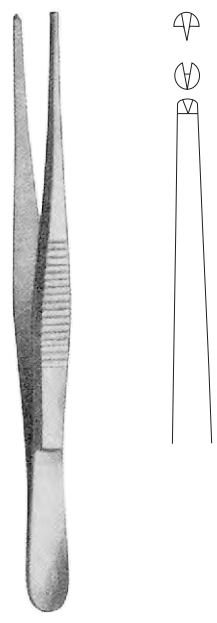

ST MARKS
1 X 2 teeth
AC-02204
290mm (11 1/2")

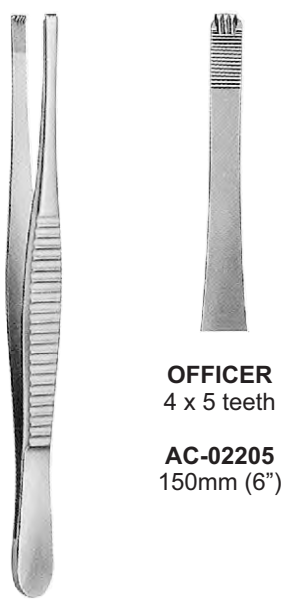

OFFICER
4 x 5 teeth
AC-02205
150mm (6")

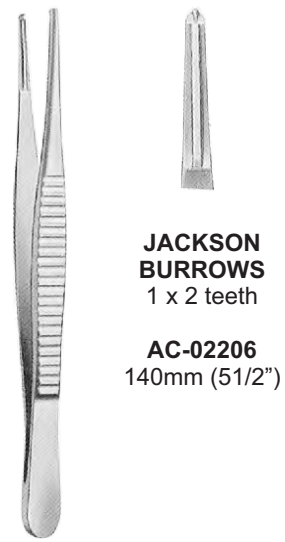

JACKSON BURROWS
1 x 2 teeth
AC-02206
140mm (5 1/2")



MUSTARDE
Combined, double hooked jaw
AC-02207
150mm (6")

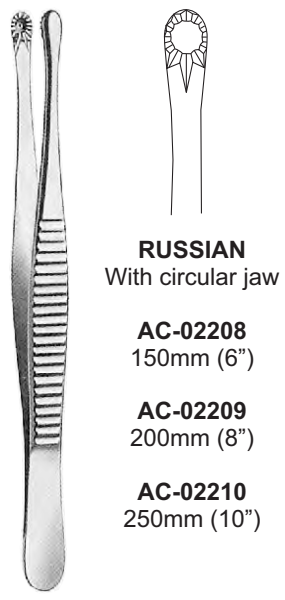

RUSSIAN
With circular jaw
AC-02208
150mm (6")
AC-02209
200mm (8")
AC-02210
250mm (10")

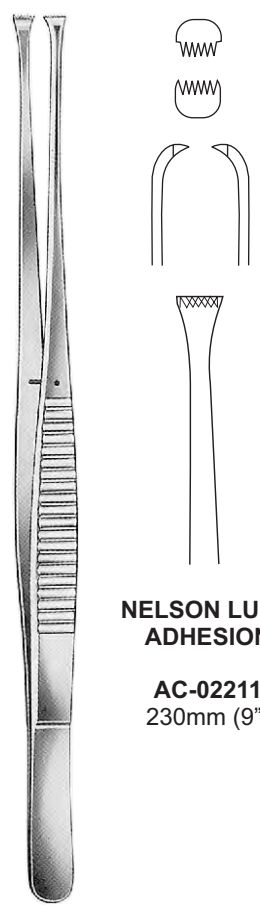

NELSON LUNG ADHESION
AC-02211
230mm (9")

INSTRUMENTS

SPLINTER FORCEPS



AC-02212
ARTHURE
140mm (5 1/2")



AC-02213
FEILCHENFEL
70mm (3")
90mm (3 1/2")
115mm (4 1/2")

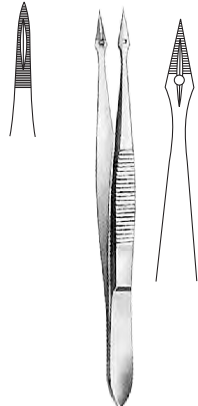

AC-02214
HUNTER
105mm (4 1/8")



DENIS BROWNE

AC-02215
190mm (7 1/2")



MICRO SOFT TOUCH RING TIP

AC-02216
150mm (6")
AC-02217
185mm (7 1/4")
AC-02218
210mm (8 1/4")
AC-02219
230mm (9")
AC-02220
250mm (10")



TROELTSCH (Wilde)
AC-02221
110mm (4 1/2")



TROELTSCH (Wilde)
AC-02222
120mm (4 3/4")
1 x 2 teeth



TUDICHUM
AC-02223
65mm (2 3/2")

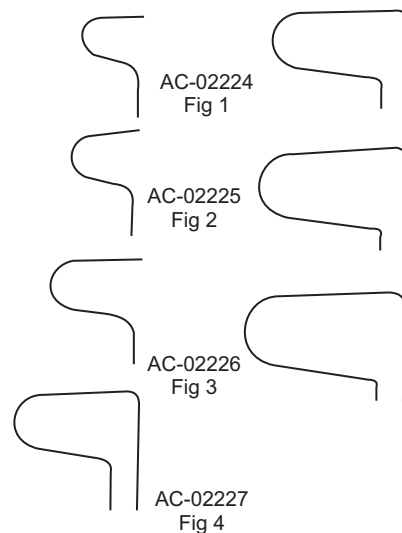

AC-02224
Fig 1

AC-02225
Fig 2

AC-02226
Fig 3

AC-02227
Fig 4

AC-02228
Fig 5

AC-02229
Fig 6

AC-02230
Fig 7



"TC" DISSECTING FORCEPS

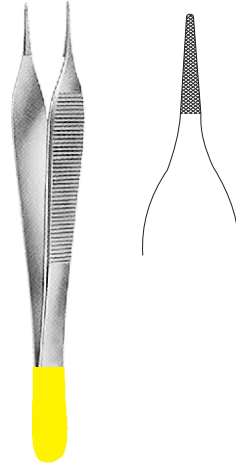

ADSON

AC-03100
120mm (43/4")

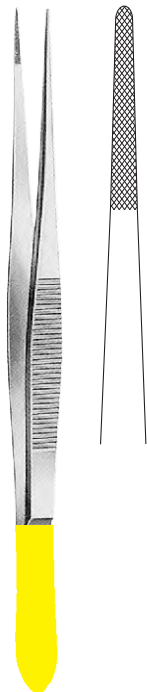

CUSHING

AC-03101
180mm (7")
With scraper end



AC-03102
145mm
(53/4")



AC-03103
200mm
(8")



AC-03104
250mm
(10")





"TC" DISSECTING FORCEPS



AC-03105
145mm
(5 3/4")



AC-03106
180mm
(7")



AC-03107
200mm
(8")

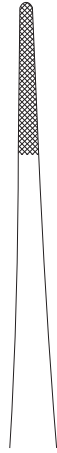

AC-03108
250mm
(10")



WANGENSTEEN



AC-03109
150mm
(6")



AC-03110
230mm
(9")





"TC" DISSECTING FORCEPS

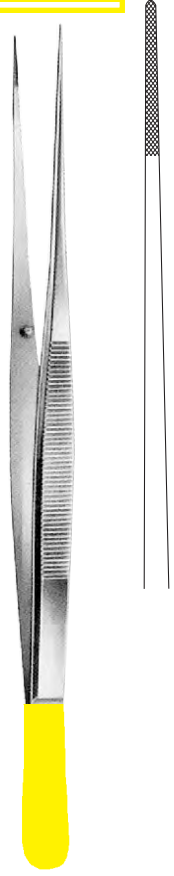

AC-03111
230mm (9")



AC-03112
185mm (7 1/4")

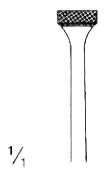

AC-03113
150mm (6")

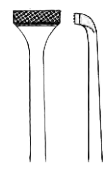

AC-03114
190mm (7 1/2")



AC-03115
160mm (6 1/4")

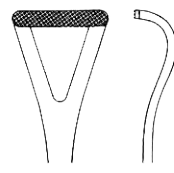

AC-03116
200mm (8")

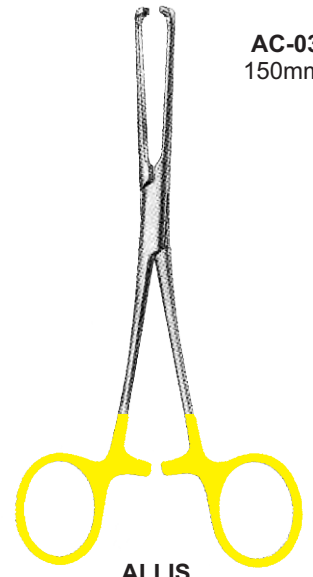

ALLIS

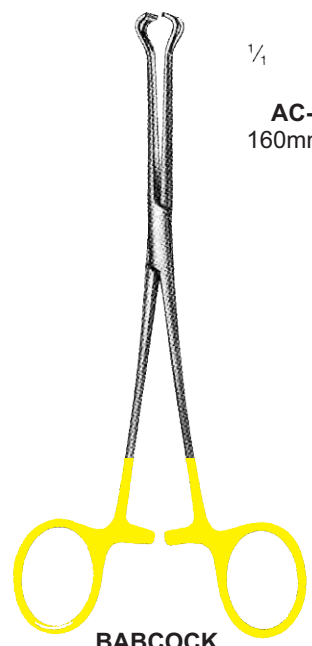

BABCOCK

INSTRUMENTS

DISSECTING & LIGATURE FORCEPS



LIGATURE FORCEPS
AE-04100
95mm (33/4")
Straight, smooth jaw



MICRO ADSON
AE-04101
140mm (5 1/2")



F4-04102
185mm (7 1/4")



AE-04103
210mm (8 1/4")

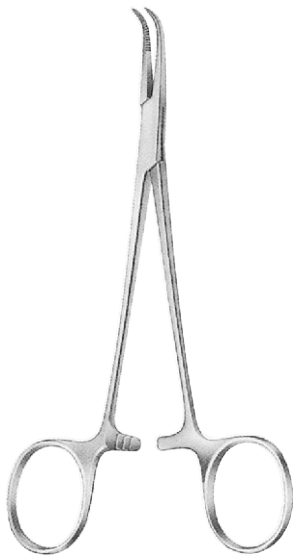

BABY - ADSON



AE-04104
140mm
(5 1/2")











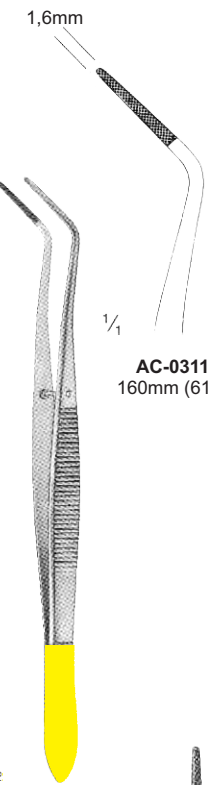

AE-04105
180mm
(7")

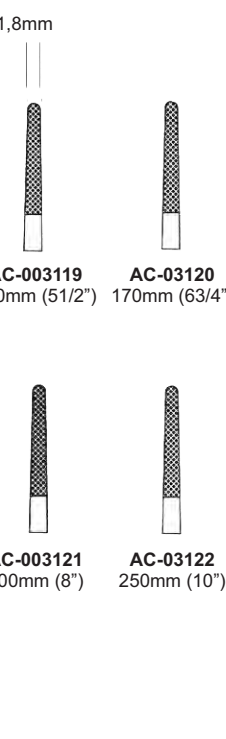

SSHAPED DELICATE

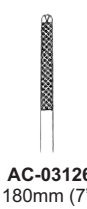

"TC" DISSECTING FORCEPS

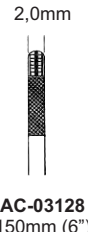
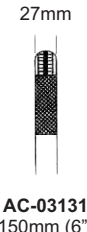
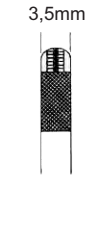
 <p>1,8mm 1/4 AC-03117 170mm (63/4")</p>	 <p>1,6mm 1/4 AC-03118 160mm (61/4")</p>		 <p>1,8mm 1/4 AC-003119 140mm (51/2")</p> <p>AC-03120 170mm (63/4")</p>	 <p>1,8mm 1/4 AC-03123 180mm (7")</p>	 <p>AC-03124 180mm (7")</p>
<p>1/2</p> <p>LUCAE</p>  <p>18mm 1/4 AC-03125 160mm (61/4")</p>  <p>AC-03126 180mm (7")</p>	<p>1/2</p> <p>MERIAM</p> 	<p>POTTS-NEVINS</p> 	<p>1/4</p> <p>AC-03127 250mm (10")</p> 	<p>1/2</p> <p>CUSHING</p>  <p>2,0mm 1/4 AC-03128 150mm (6")</p>  <p>27mm AC-03131 150mm (6")</p>  <p>3,5mm AC-03132 200mm (8")</p>	<p>AC-03134 200mm (8")</p> <p>AC-03135 240mm (91/2")</p>
<p>SEMKEN</p>	<p>SEMKEN</p>	<p>DEBAKEY</p>			

INSTRUMENTS



DISSECTING & LIGATURE FORCEPS



AE-04106
215mm (8 1/2")



AE-04107
210mm (8 1/4")



AE-04108
220mm (8 3/4")



AE-04109
225mm (9")



AE-04110
225mm (9")

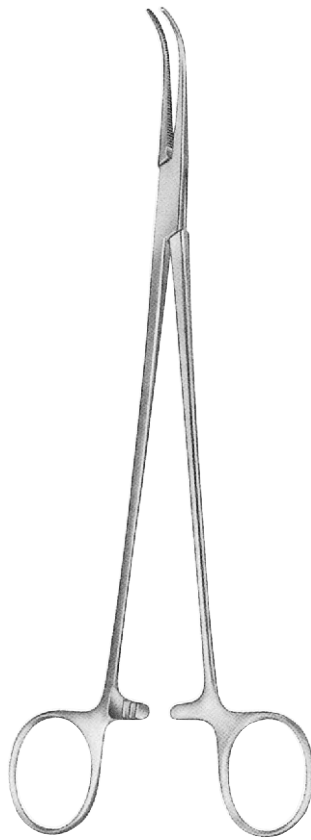

**FINE CURVED DISSECTING
FORCEPS**



AE-04111
295mm (11 3/4")



AE-04112
295mm (11 3/4")



F5-04113
300mm (12")





"TC" DISSECTING FORCEPS



STANDARD



ADSON-BROWN



ADSON



AE-03138
120mm (43/4")

AE-03139
150mm (6")



AE-03140
120mm (43/4")

AE-03141
150mm (6")

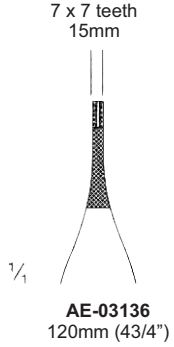

AE-03136
120mm (43/4")

AE-03137
150mm (6")

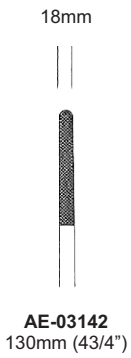

AE-03142
130mm (43/4")

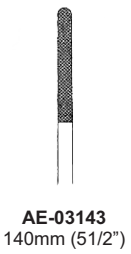

AE-03143
140mm (5 1/2")



AE-03144
160mm (6 1/4")

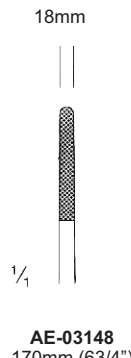

AE-03148
170mm (6 3/4")

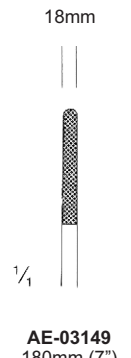

AE-03149
180mm (7")

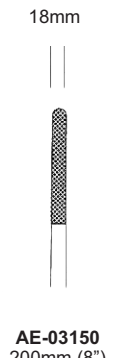

AE-03150
200mm (8")

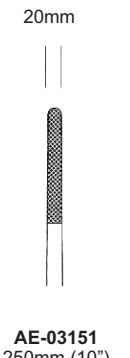

AE-03151
250mm (10")

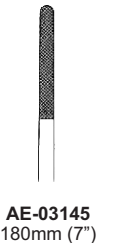

AE-03145
180mm (7")

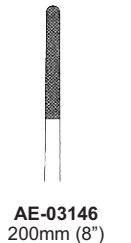

AE-03146
200mm (8")



AE-03147
250mm (10")



POTTS-SMITH



POTTS-SMITH

INSTRUMENTS

F5(a)

Email: adas.surgical@gmail.com / www.adasinstruments.net / whatsapp / viber : 0092 321 612 6625

TISSUE FORCEPS



RUTHERFORD MORISON

AE-04201
150mm (6")
6 x 7 teeth

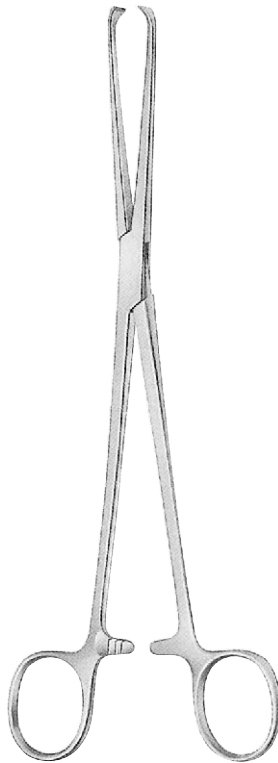

STILES (ALLIS-THOMS)

AE-04202
200mm (8")
6 x 7 teeth



LANE

1 x 2 teeth fenestrated

AE-04203
125mm (5")

AE-04204
150mm (6")

AE-04205
195mm (7³/₄")



TISSUE FORCEPS



BABCOCK
AE-04206
165mm (6 1/2")

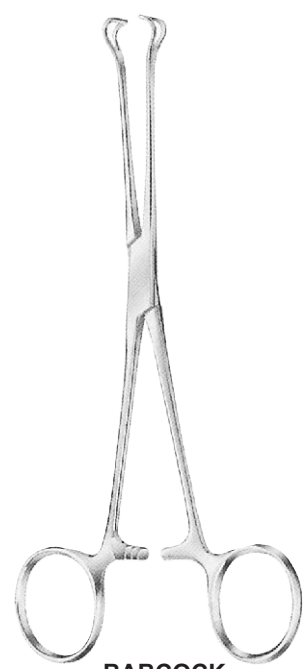

BABCOCK
AE-04207
200mm (8")
Extra light



BABCOCK
AE-04208
230mm (9")

INSTRUMENTS

TISSUE FORCEPS

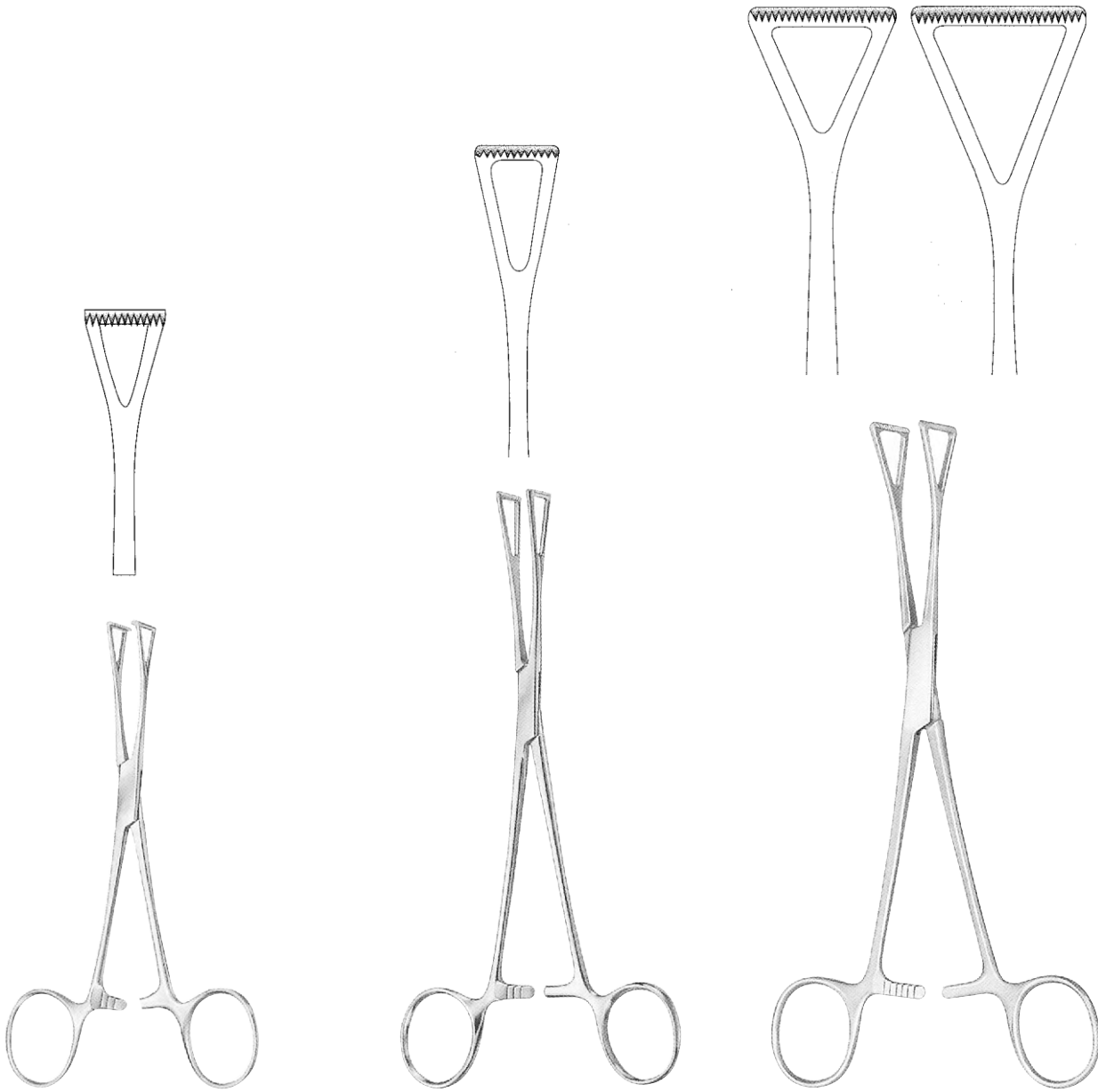

DUVAL

AE-04209
140mm (5 1/2")

DUVAL

AE-04210
180mm (7")

DUVAL

AE-04211
190mm (7 1/2")

AE-04212
200mm (8")



MOUTH GAGS

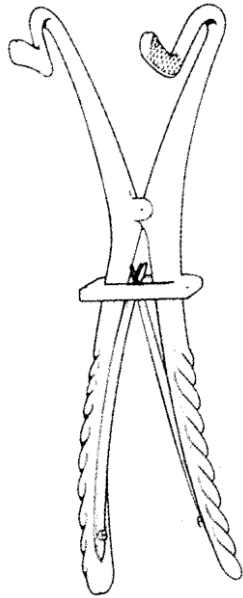

FERGUSSON ACLAND

AG-04300
170mm (63/4")

AG-04301
200mm (8")



DOYEN (CHILD)

AG-04302
120mm (43/4")

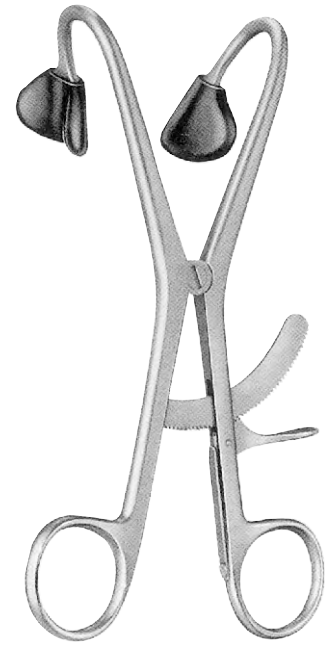

FEATHERSTONE

AG-04303
165mm (61/2")



DOYEN (ADULT)

AG-04304
140mm (51/2")



TONGUE DEPRESSORS

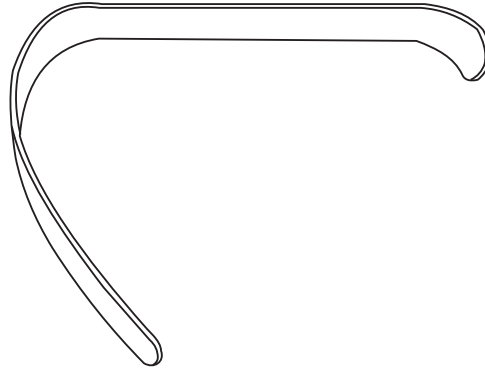

LACK TONGUE DEPRESSOR

AG-04305
13mm wide
child

AG-04306
19mm wide
Adolescent

AG-04307
22mm wide
Adults

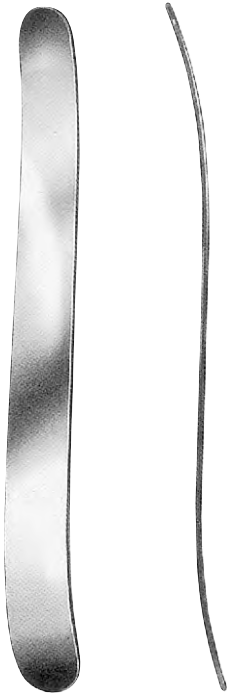

AG-04308
180mm (7")

FLAT TONGUE DEPRESSOR

Double ended
tapering 19mm + 23mm



AG-04309
140mm (5 1/2")





TONGUE DEPRESSORS



AG-04310



AG-04311



COLLIN TONGUE FORCEPS

AG-04310
170mm (63/4")

AG-04311
160mm (61/4")



HEYWOOD-SMITH TONGUE FORCEPS

AG-04312
200mm (8")

INSTRUMENTS

PREPARATION INSTRUMENTS



AG-04313



AG-04314



MAGILL CATHETER INTRODUCING FORCEPS

CHILD
AG-04313
200mm (8")

ADULT
AG-04314
250mm (10")



TOWEL CLAMPS



ROBIN

AE-04400
140mm (5 1/2")
holder diameter 5mm

AE-04401
140mm (5 1/2")
holder diameter 13mm

AE-04402
140mm (5 1/2")
holder diameter 25mm

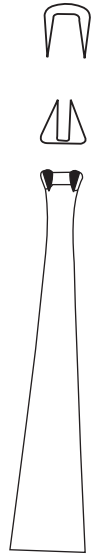

EDNA (LORNA)

AE-04403
100mm (4")

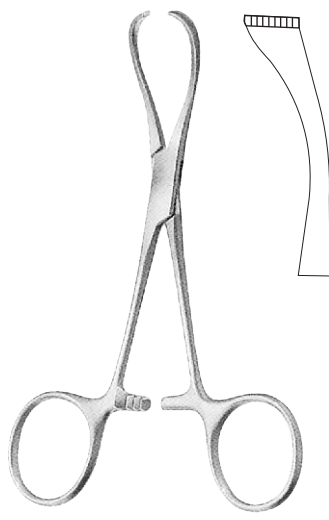

EDNA (LORNA)

AE-04404
130mm (5 1/4")



DOYEN

AE-04405
190mm (7 1/2")

INSTRUMENTS



TOWEL CLAMPS



BALL AND SOCKET

AE-04406
130mm (5")

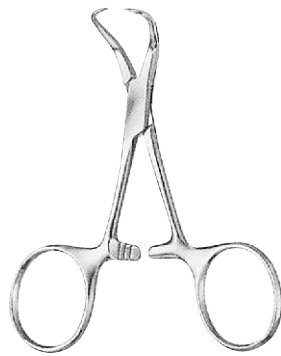

BACKHAUS

AE-04407
90mm (3 1/2")

AE-04408
100mm (4 3/4")

AE-04409
135mm (5 1/4")

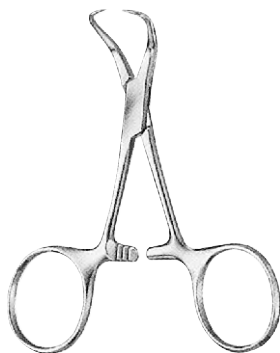

MAYO

AE-04410
140mm (5 1/2")

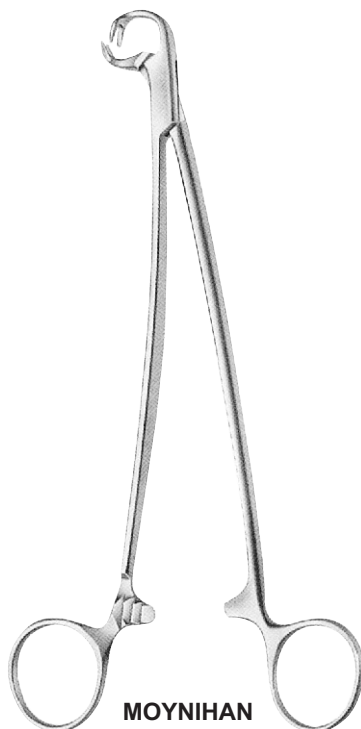

MOYNIHAN

AE-04411
190mm (7 1/2")
2 x 2 teeth





SAFETY PIN FORCEPS HOLDERS



SCHAEDEL

AE-04412
90mm (3 1/8")
Cross action

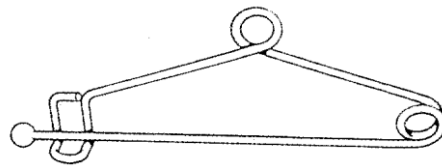

MAYO SAFETY PIN FORCEPS HOLDER

AE-04413
115mm (4 1/2")

SPONGE HOLDING FORCEPS



RAMPLEY

AE-04500
180mm (7")

AE-04501
240mm (9 1/2")



FORESTER

AE-04502
240mm (9 1/2")

AE-04503
180mm (7")
Straight

AE-04504
240mm (9 1/2")

AE-04505
180mm (7")
Curved on flat

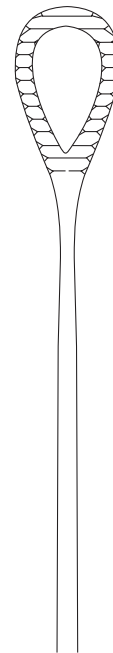

AE-04502

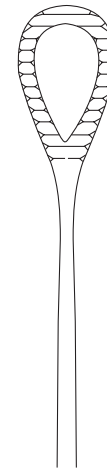

AE-04503

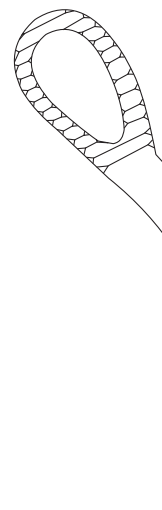

AE-04504

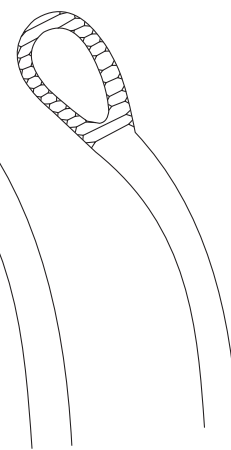

AE-04505



DRESSING FORCEPS

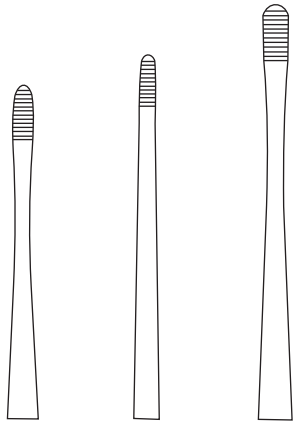

AE-04506 125mm (5")
AE-04507 150mm (6")
AE-04508 180mm (7")

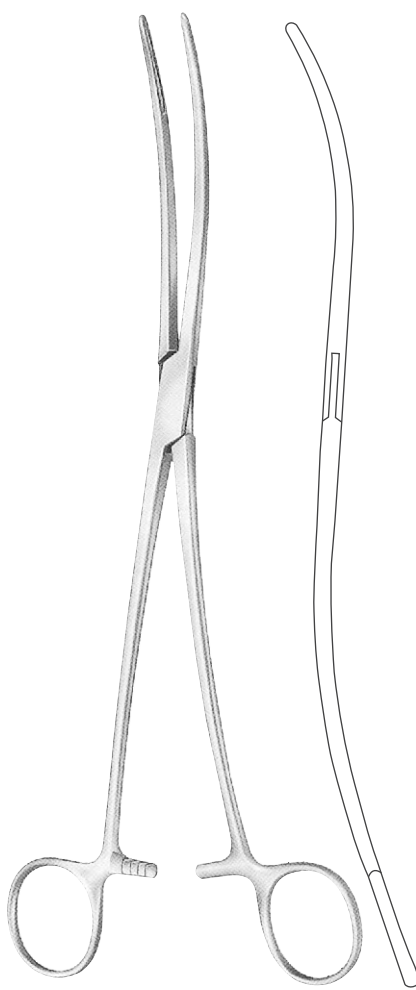

BOZEMANN UTERINE DRESSING FORCEPS
AE-04509
255mm (10")
Jaws with longitudinal groove

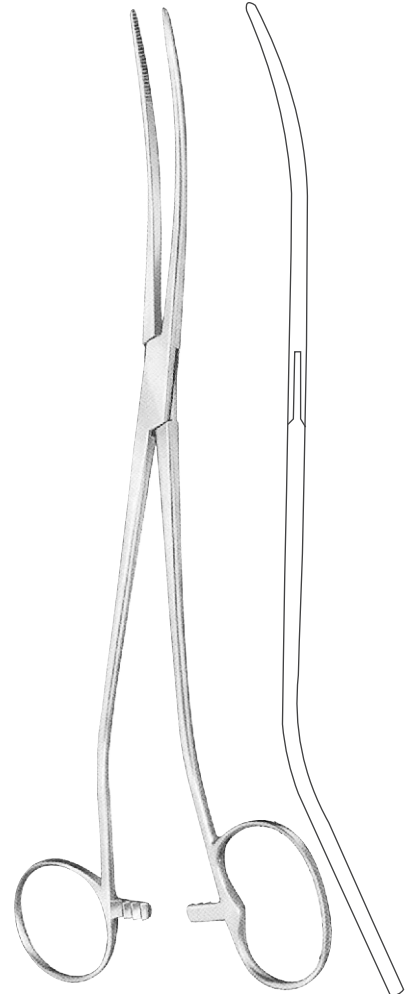

BOZEMANN
AE-04510
260mm (10 1/4")
Serrated jaws, on large bow

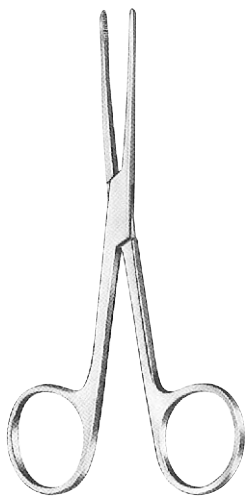

LISTER - SINUS

DRESSING FORCEPS

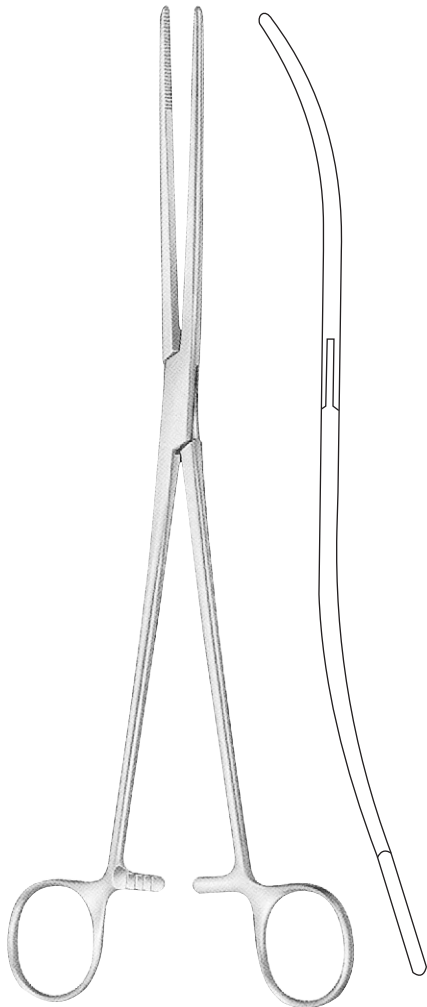

BOZEMANN
AE-04511
250mm (10")
S-shaped curve



BOZEMANN
AE-04512
260mm (10 1/4")
Straight

AE-04513
250mm (10")
Curved



HAEMOSTATS FORCEPS

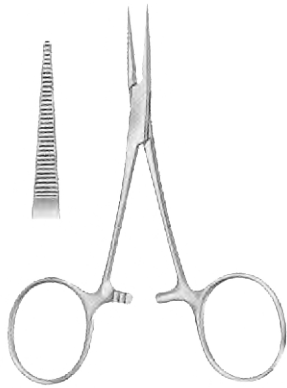

HALSTEAD MOSQUITO

AE-05100
100mm (4")
Straight



HALSTEAD MOSQUITO

AE-05101
100mm (4")
Curved on flat



HALSTEAD MOSQUITO

100mm (4")
1 x 2 teeth

AE-05102
Straight

AE-05103
Curved on flat

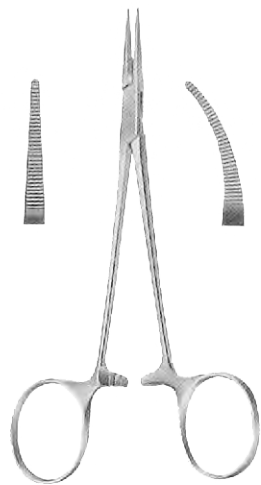

HALSTEAD MOSQUITO

125mm (5")

AE-05104
Straight

AE-05105
Curved on flat



HALSTEAD MOSQUITO

125mm (5")
1 x 2 teeth

AE-05106
Straight

AE-05107
Curved on flat



BABY - CRILE

AE-05108
140mm (5 1/2")
Straight

HAEMOSTATS FORCEPS



BABY-CRILE

AE-05109
140mm (5 1/2")
Curved on flat



BABY-CRILE

AE-05110
140mm (5 1/2")
Straight
1 x 2 teeth

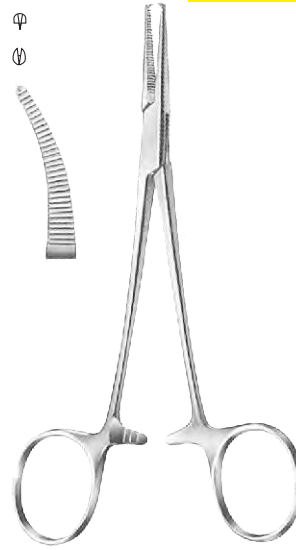

BABY CRILE

AE-05111
140mm (5 1/2")
Curved on flat
1 x 2 teeth

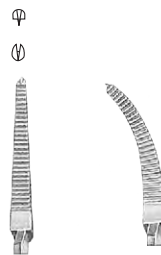

HALSTEAD MOSQUITO
125mm (5")

AE-05112
Straight

AE-05113
Curved on flat



HALSTEAD MOSQUITO
125mm (5")
1 x 2 teeth

AE-05114
Straight

AE-05115
Curved on flat



HAEMOSTATS FORCEPS



GREY TURNER
Straight

AE-05116
145mm (5³/₄")

AE-05117
180mm (7")



GREY TURNER
Curved on flat

AE-05118
145mm (5³/₄")

AE-05119
180mm (7")



CUSHING

AE-05120
145mm (5³/₄")
Straight

AE-05121
145mm (5³/₄")
Curved on flat

AE-05122
145mm (5³/₄")
Curved to side

HAEMOSTATS FORCEPS



CAIRNS

AE-05123
145mm (53/4")

AE-05124
145mm (53/4")
Curved on flat

AE-05125
145mm (53/4")
Curved to side



CRAFOORD

AE-05126
254mm (93/4")
Curved on flat

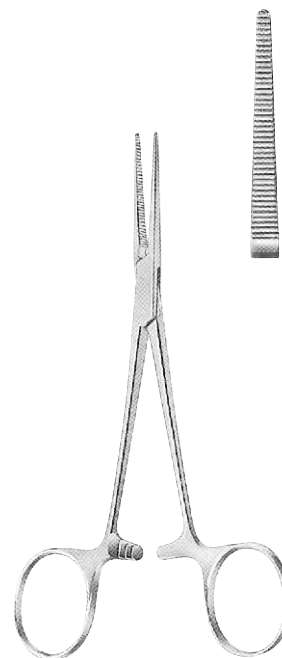

CRILE Straight

AE-05127
140mm (51/2")

AE-05128
160mm (61/4")

AE-05129
180mm (7")



HAEMOSTATS FORCEPS

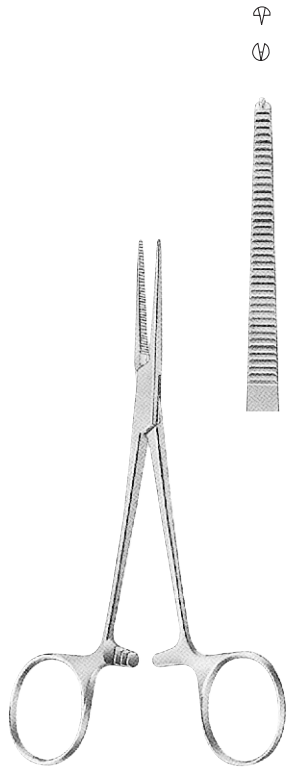

CRILE
1 x 2 teeth
AE-05130
160mm (6 1/4")
Straight

AE-05131
160mm (6 1/4")
Curved on flat

AE-05132
140mm (5 1/2")
Straight

AE-05133
140mm (5 1/2")
Curved on flat



CRILE
Curved on flat
AE-05134
140mm (5 1/2")

AE-05135
160mm (6 1/4")

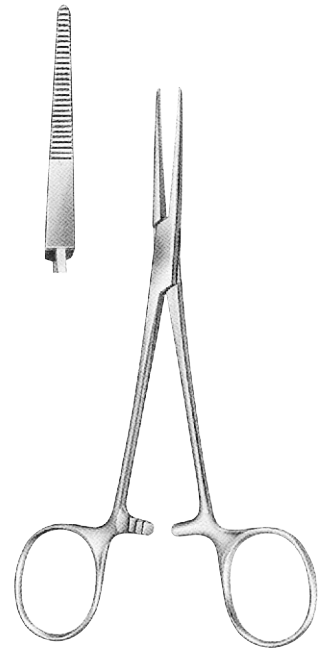

KELLY-CRILE
Straight
AE-05136
140mm (5 1/2")

AE-05137
160mm (6 1/4")

HAEMOSTATS FORCEPS

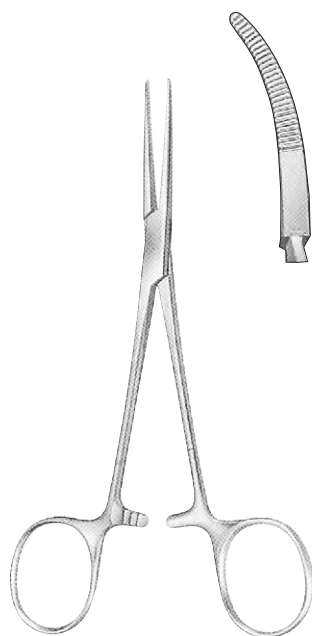

KELLY
Curved on flat

AE-05138
140mm (5 1/2")

AE-05139
160mm (6 1/4")



KELLY HALSTEAD

AE-05140
140mm (5 1/2")
Straight

AE-05141
140mm (5 1/2")
Curved on flat



KOCHER
Straight 1 x 2 teeth

AE-05142
125mm (5")

AE-05143
140mm (5 1/2")

AE-05144
150mm (6")

AE-05145
180mm (7")

AE-05146
200mm (8")

AE-05147
225mm (9")





HAEMOSTATS FORCEPS

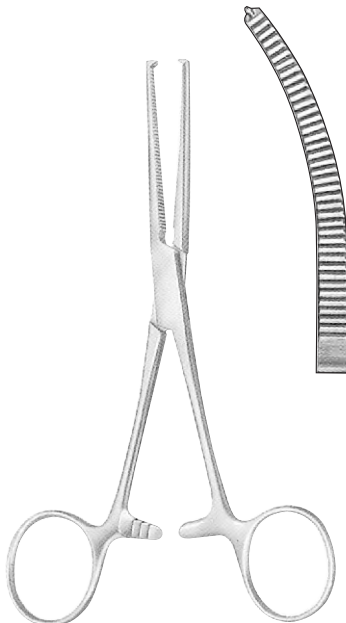

KOCHER
Curved on flat 1 x 2 teeth

AE-05148
125mm (5")

AE-05149
140mm (5 1/2")

AE-05150
150mm (6")

AE-05151
180mm (7")

AE-05152
200mm (8")

AE-05153
225 (9")



LLOYD DAVIS

AE-05154
260mm (10 1/4")
Curved on flat

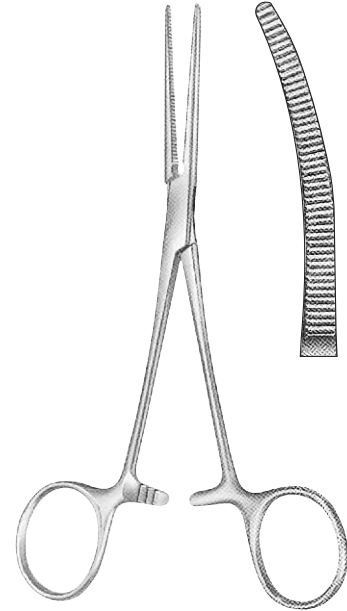

MAYO

AE-05156
160mm (6 1/4")
Curved on flat

HAEMOSTATS FORCEPS

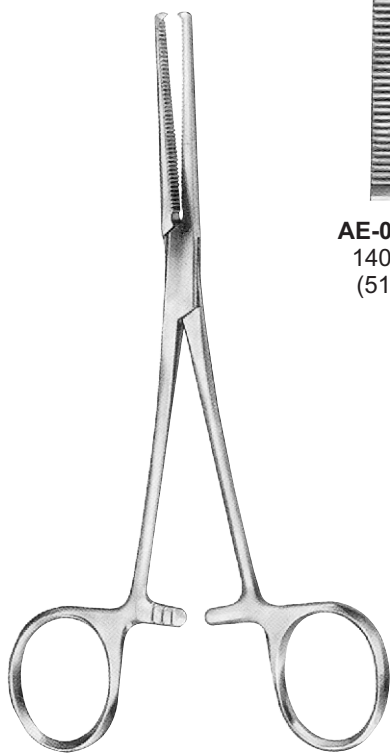

ROCHESTER - OSCHNER
Straight
1 x 2 teeth

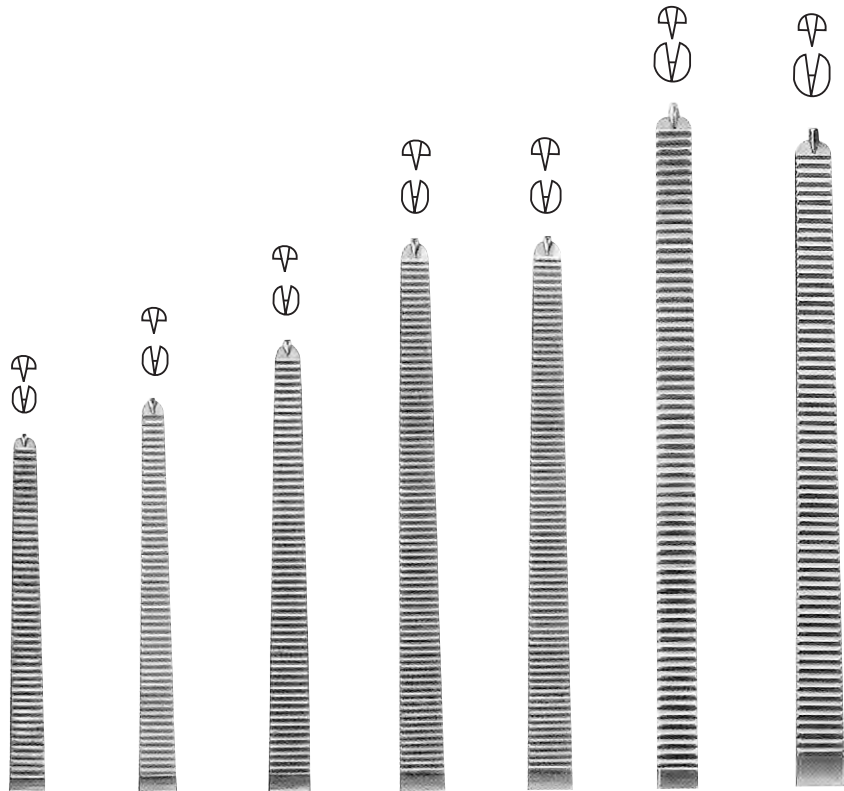

- | | | | | | | |
|-------------------|-------------------|-------------------|-----------------|-----------------|-------------------|--------------------|
| AE-05157 | AE-05158 | AE-05159 | AE-05160 | AE-05161 | AE-05162 | AE-05163 |
| 140mm
(5 1/2") | 160mm
(6 1/4") | 185mm
(7 1/4") | 200mm
(8") | 225mm
(9") | 240mm
(9 1/2") | 260mm
(10 1/4") |



HAEMOSTATS FORCEPS

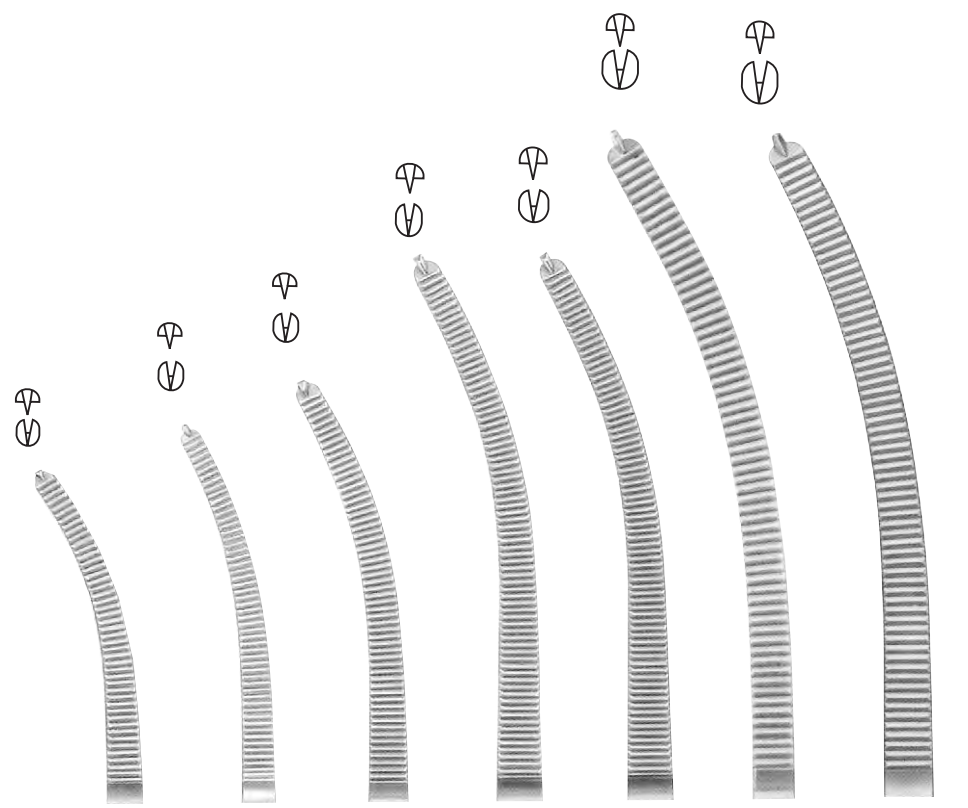

- AE-05164** 140mm (5 1/2")
- AE-05165** 160mm (6 1/4")
- AE-05166** 185mm (7 1/4")
- AE-05167** 200mm (8")
- AE-05168** 225mm (9")
- AE-05169** 240mm (9 1/2")
- AE-05170** 260mm (10 1/4")



ROCHESTER - OSCHNER
Curved
1 x 2 teeth

INSTRUMENTS

HAEMOSTATS FORCEPS



AE-05172
180mm (7")
Curved on flat



AE-05173
180mm (7")
Straight

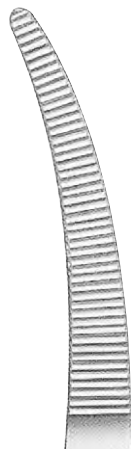

AE-05174
185mm (7 1/4")
Curved on flat
1 x 2 teeth



AE-05175
185mm (7 1/4")
Straight
1 x 2 teeth



FRASER - ADSON



FRASER-KELLY (CRILE)

AE-05171
180mm (7")
Curved on flat



DUNHILL

AE-05176
125mm (5")
Curved on flat

AE-05177
125mm (5")
Straight

AE-05178
180mm (7")
Curved on flat



HAEMOSTATS FORCEPS

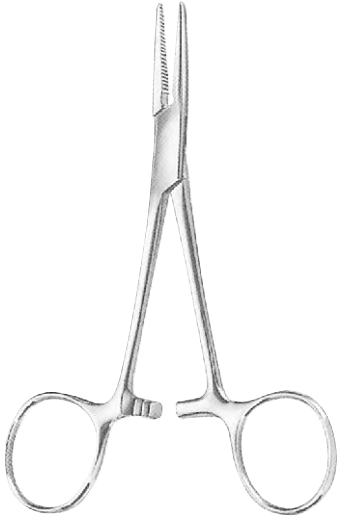

SPENCER WELLS
Straight

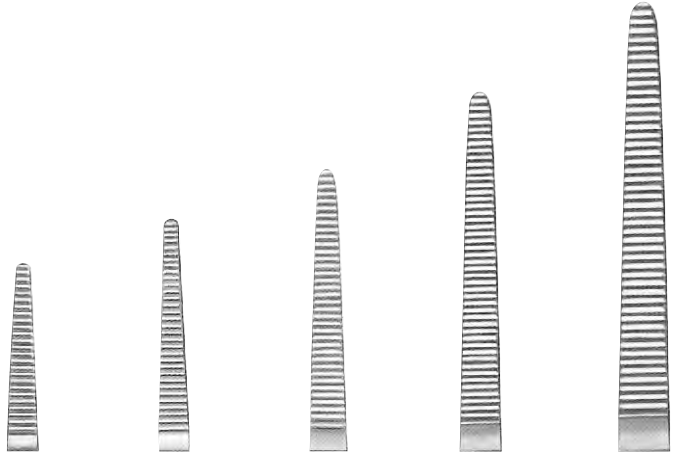

- AE-05179**
125mm
(5")
- AE-05180**
150mm
(6")
- AE-05181**
180mm
(7")
- AE-05182**
200mm
(8")
- AE-05183**
225mm
(9")

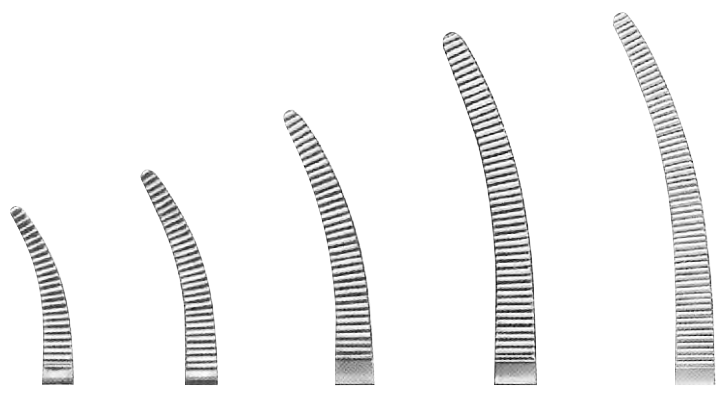

- AE-05184**
125mm
(5")
- AE-05185**
150mm
(6")
- AE-05186**
180mm
(7")
- AE-05187**
200mm
(8")
- AE-05188**
225mm
(9")

SPENCER WELLS
Curved on flat

INSTRUMENTS

HAEMOSTATS FORCEPS



ROCHSTER PEAN
Straight

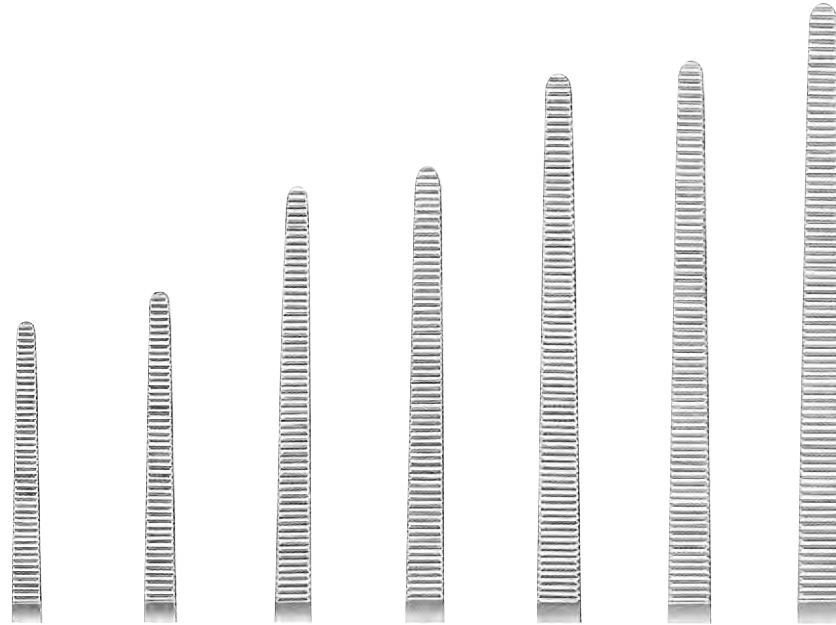

- | | | | | | | |
|-------------------|-------------------|-------------------|-----------------|-----------------|-------------------|--------------------|
| AE-05189 | AE-05190 | AE-05191 | AE-05192 | AE-05193 | AE-05194 | AE-05195 |
| 140mm
(5 1/2") | 160mm
(6 1/4") | 185mm
(7 1/4") | 200mm
(8") | 225mm
(9") | 240mm
(9 1/2") | 260mm
(10 1/4") |



- | | | | | | | |
|-------------------|-------------------|-------------------|-----------------|-----------------|-------------------|--------------------|
| AE-05196 | AE-05197 | AE-05198 | AE-05199 | AE-05200 | AE-05201 | AE-05202 |
| 140mm
(5 1/2") | 160mm
(6 1/4") | 185mm
(7 1/4") | 200mm
(8") | 225mm
(9") | 240mm
(9 1/2") | 260mm
(10 1/4") |

ROCHSTER PEAN
Curved on flat



HAEMOSTATS FORCEPS



HEISS

AE-05203
200mm (8")
Straight

AE-05204
200mm (8")
Curved on side

AE-05205
200mm (8")
Straight 1 x 2 teeth

AE-05206
200mm (8")
Curved on flat 1 x 2 teeth

BIRKETT

AE-05207
180mm (7")
Straight

AE-05208
180mm (7")
Curved to side

AE-05209
180mm (7")
Curved on flat

ROBERTS

Curved on flat

AE-05210
230mm (9")
Screw joint

AE-05211
230mm (9")
Box joint

TONSIL ARTERY FORCEPS



AE-05213



AE-05214



SCHNIDT TONSIL

AE-05212
180mm (7")
Slight curved on flat

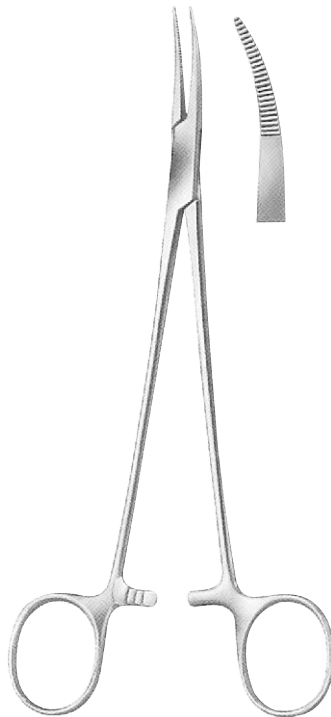

NEGUS TONSIL

AE-05213
180mm (7")
Small curved

AE-05214
180mm (7")
Large curved

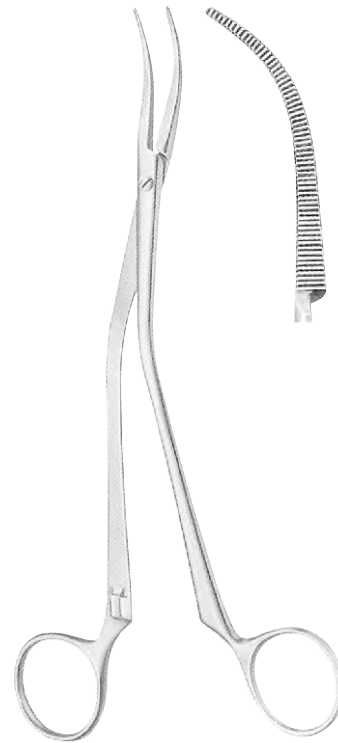

WILSON TONSIL

AE-05215
190mm (7 1/2")
Curved on flat
Angled shafts



HAEMOSTATS FORCEPS



AE-05216
140mm (5 1/2")

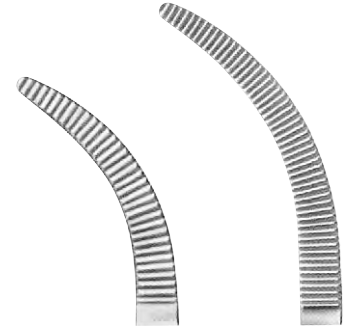

AE-05219 **AE-05220**

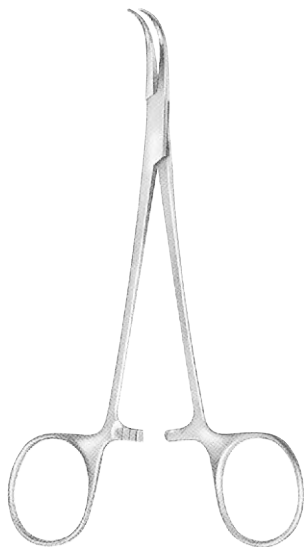

MIXTER
Curved on flat



AE-05217
180mm (7")



AE-05218
230mm (9")

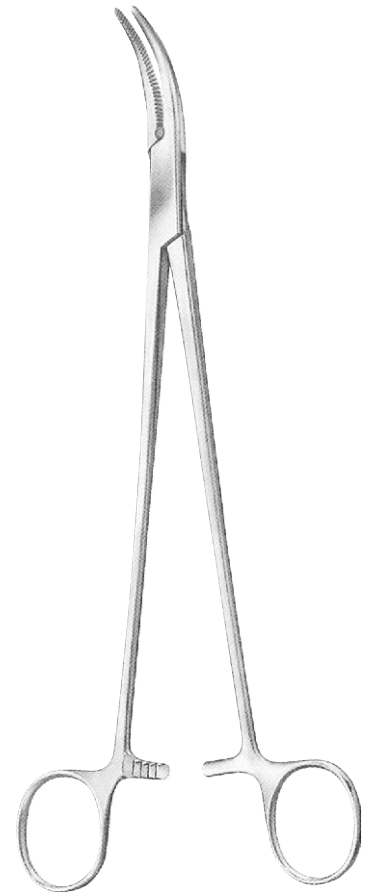

MOYNIHAN

AE-05219
230mm (9")

AE-05220
240mm (9 1/2")

HAEMOSTATS FORCEPS

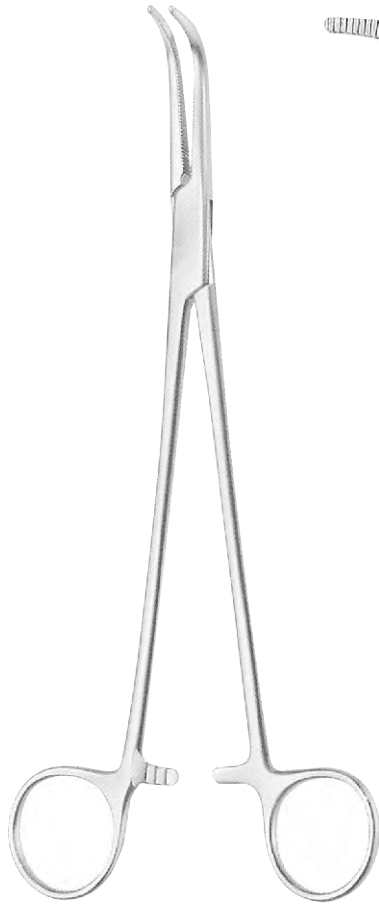

AE-05221
150mm
(6")

AE-05222
180mm
(7")

AE-05223
200mm
(8")

AE-05224
230mm
(9")

AE-05225
255mm
(10")

O'SHAUGHNESSY
Curved, lightweight



TUBING CLAMP
Heavy pattern
wedge jaw

AE-05226
150mm (6")

AE-05227
180mm (7")

AE-05228
200mm (8")



AE-05229

AE-05230

FICKLING ORAL

AE-05229
180mm (7")
Angled to side
1 x 2 teeth

AE-05230
180mm (7")
Angled to side



DISSECTING & LIGATURE FORCEPS



LIGATURE FORCEPS
AE-05231
95mm (33/4")
Straight, smooth jaw



AE-045232
140mm (5 1/2")

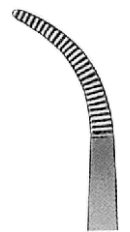

AE-05233
185mm (7 1/4")

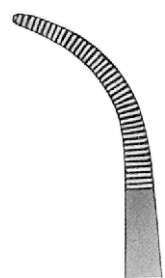

AE-05234
210mm (8 1/4")

MICRO ADSON

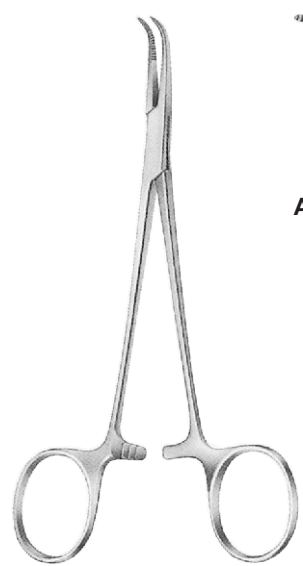

BABY - ADSON



AE-05235
140mm
(5 1/2")



AE-05236
180mm
(7")



SSHAPED DELICATE

INSTRUMENTS

DISSECTING & LIGATURE FORCEPS

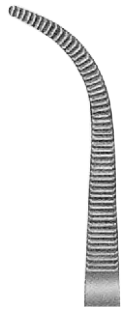

AE-05237
215mm (8 1/2")



AE-05238
210mm (8 1/4")



AE-05239
220mm (8 3/4")



AE-05240
225mm (9")



AE-05241
225mm (9")



AE-05242
295mm (11 3/4")



AE-05243
295mm (11 3/4")

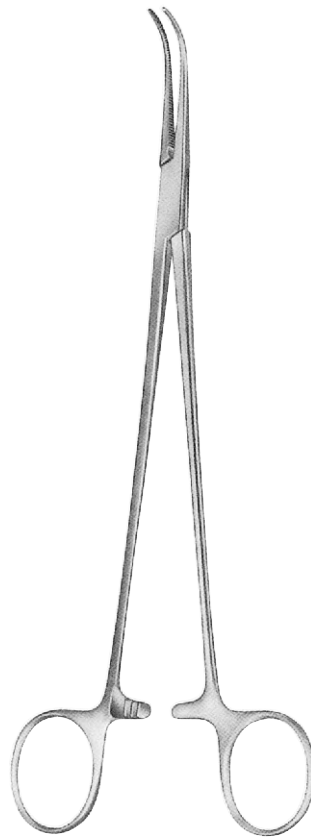

**FINE CURVED DISSECTING
FORCEPS**



AE-05244
300mm (12")



DISSECTING & LIGATURE FORCEPS

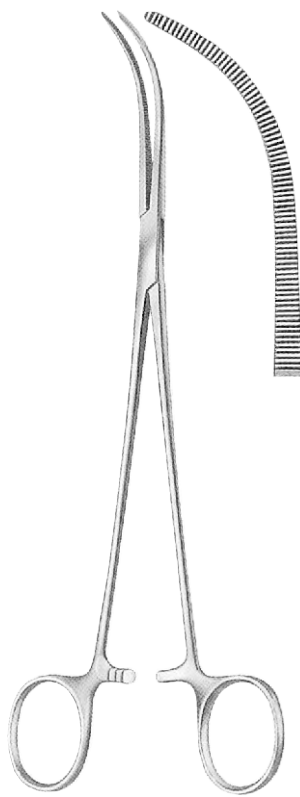

MIXTER
AE-05245
200mm (8")



LAWRENCE
AE-05246
270mm (10 3/4")

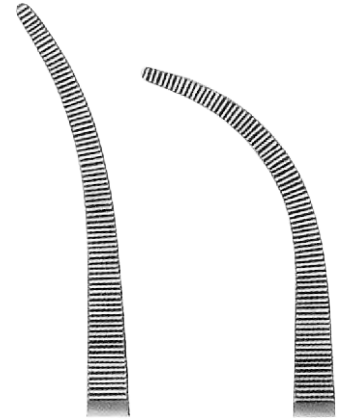

AE-05247
300mm
(12")

AE-05248
290mm
(11 1/2")



LONG CURVED FORCEPS



TISSUE FORCEPS

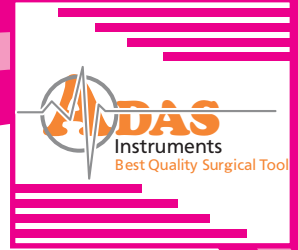

ALLIS
150mm (6")

AE-05250
2 x 3 teeth

AE-05251
3 x 4 teeth

AE-05252
4 x 5 teeth

AE-05253
5 x 6 teeth

AE-05254
6 x 7 teeth



AE-05255



AE-05256

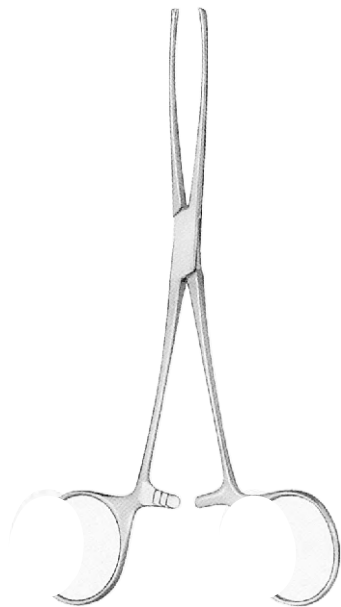

AMERICAN PATTERN ALLIS

AE-05249
150mm (6")
3 x 4 teeth

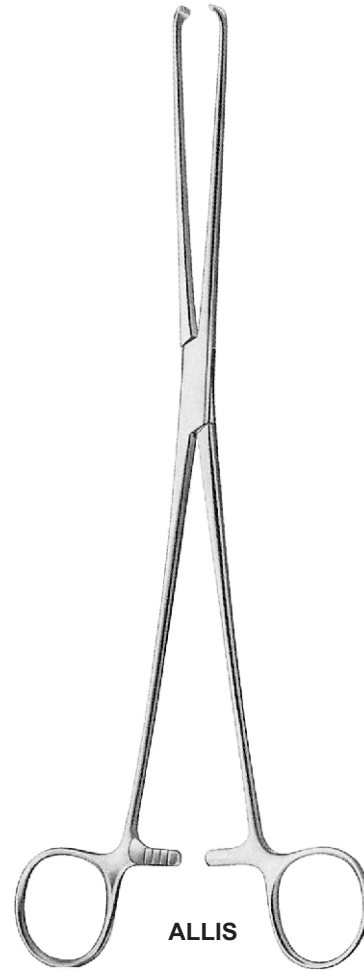

ALLIS

AE-05255
190mm (7 1/2")

AE-05256
255mm (10")
5 x 6 Teeth





TISSUE FORCEPS

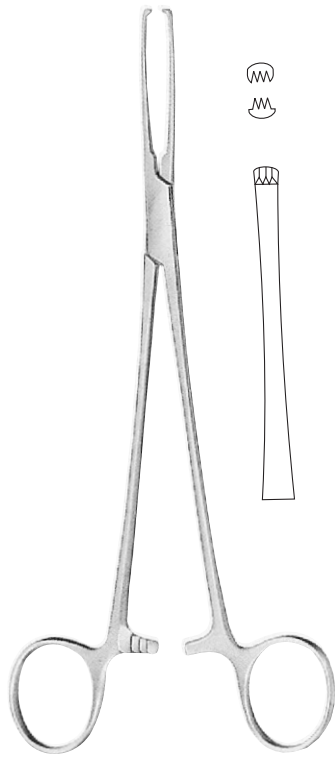

JUD-ALLIS

AE-05257
195mm (73/4")
Light pattern, 3 x 4 teeth

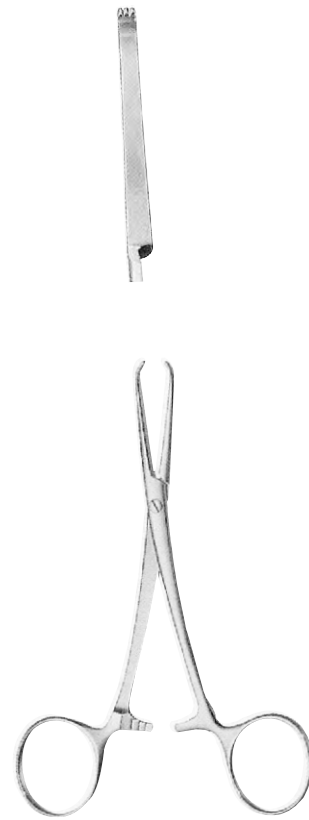

CHAPUT (POIRIER)

AE-05258
125mm (5")
2 x 3 teeth



TISSUE FORCEPS

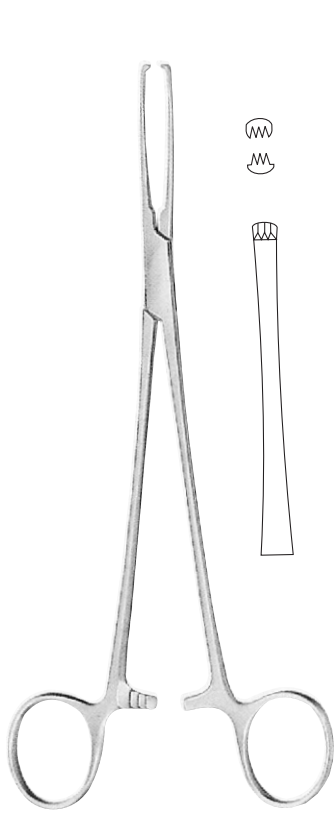

JUD-ALLIS

AE-05257
195mm (73/4")
Light pattern, 3 x 4 teeth

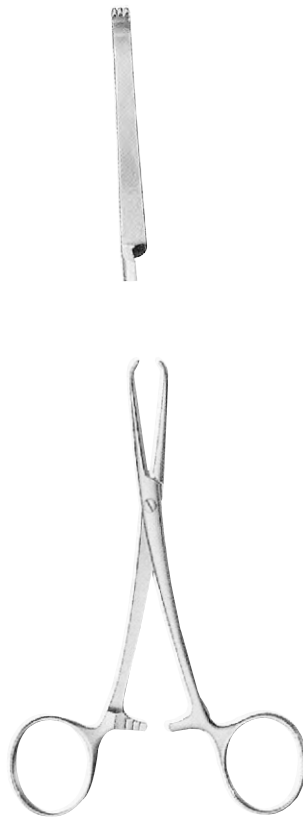

CHAPUT (POIRIER)

AE-05258
125mm (5")
2 x 3 teeth



LITTLEWOOD

AE-05259
185mm (71/4")
2 x 3 teeth





TISSUE FORCEPS



LITTLEWOOD

AE-05259
185mm (7 1/4")
2 x 3 teeth



TUBING CLAMP

AE-05260
175mm (7")

AE-05261
200mm (8")

MICRO NEEDLE HOLDERS



CASTROVIEJO

AF-06100
145mm (53/4")
With catch



CASTROVIEJO

AF-06101
145mm (53/4")
With catch



ARRUGA

AF-06102
135mm (51/4")



BARRAQUER

AF-06103
120mm (43/4")
With catch



BARRAQUER

AF-06104
120mm (43/4")
Without catch



NEEDLE HOLDERS

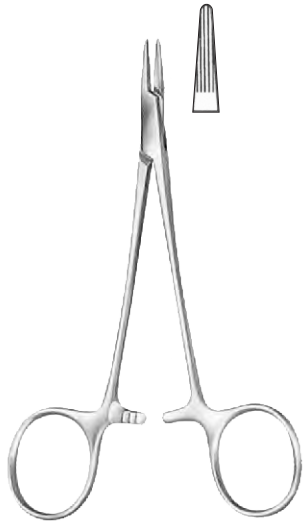

CONVERSE

AF-06105
125mm (5")



DERF

AF-06106
120mm (43/4")



MAYO (DUNHILL)

AF-06107
160mm (6 1/4")



MAYO

AF-06108
180mm (7")



MAYO

AF-06109
190mm (7 1/2")



NEEDLE HOLDERS



CRILE WOOD

AF-06110
150mm (6")



CRILE MURRAY

AF-06111
145mm (53/4")



NAUNTON MORGAN

AF-06112
190mm (71/2")

AF-06113
250mm (10")

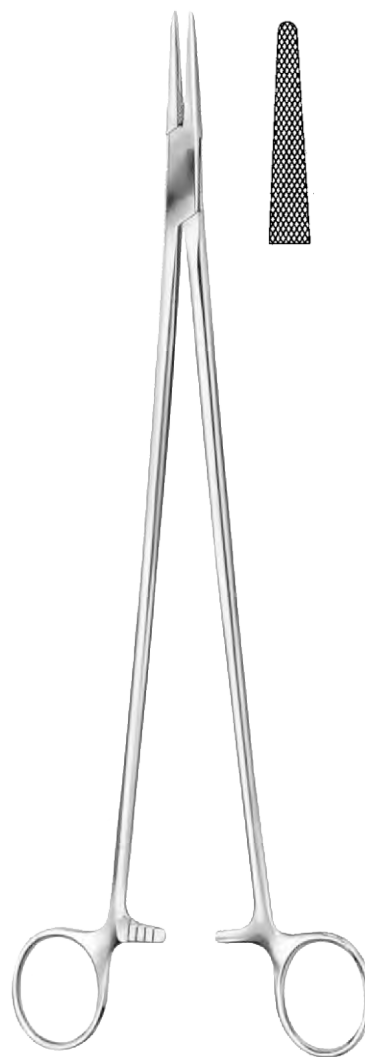

WANGENSTEEN

AF-06114
270mm (103/4")





NEEDLE HOLDERS

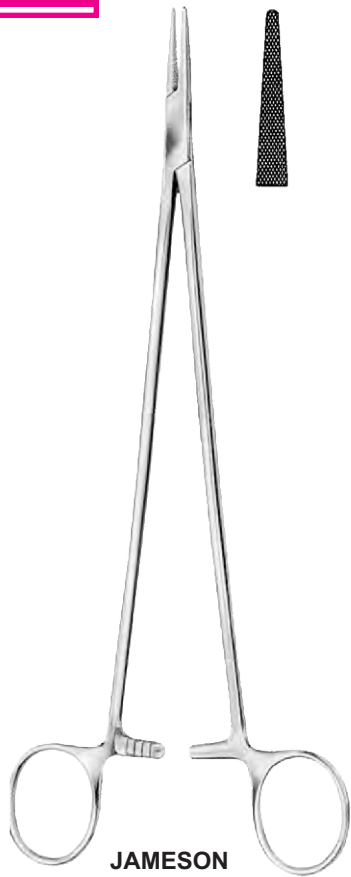

JAMESON

AF-06115
230mm (9")



WRIGHT

AF-06116
125mm (5")



GILLIES
Combined needle holder
and scissors

AF-06119
160mm (6 1/4")



KILNER

AF-06117
135mm (5 1/4")



HEANEY

AF-06118
200mm (8")



NEEDLE HOLDERS

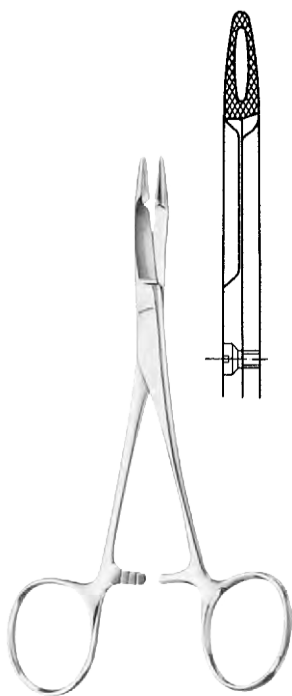

OLSEN HEGAR
Combined needle holder
and scissors

AF-06120
140mm (5 1/2")

AF-06121
165mm (6 1/2")

AF-06122
190mm (7 1/2")

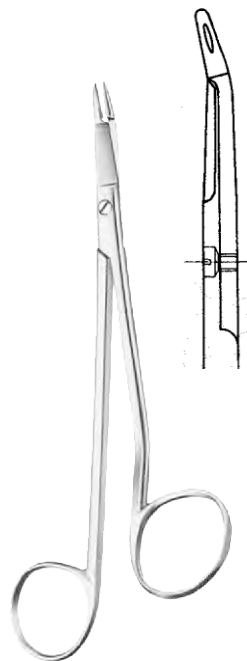

WARD
Combined needle holder
and scissors

AF-06123
180mm (7")





NEEDLE HOLDERS



MAYO (BAUMGARTNER)



AF-06124
140mm (5 1/2")

MAYO (MASSON)



AF-06125
265mm (10 1/2")

MAYO



AF-06126
165mm (6 1/2")



AF-06127
190mm (7 1/2")

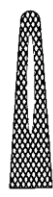

AF-06128
200mm (8")



AF-06129
230mm (9")

HEGAR



AF-06130
200mm (8")



NEEDLE HOLDERS

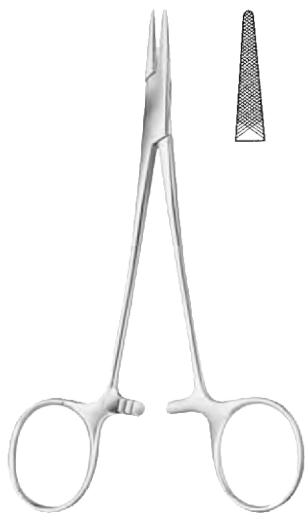

HALSEY

AF-06131
125mm (5")



MATHIEU

AF-06132
140mm (5 1/2")



MATHIEU

AF-06133
170mm (6 3/4")



MATHIEU

AF-06134
200mm (8")





NEEDLE HOLDERS



WEBSTER
Smooth Jaw

AF-06135
115mm (4 1/2")



LAWRANCE

AF-06136
150mm (6")
Lightweight

AF-06137
150mm (6")



MAYO

AF-06138
150mm (6")

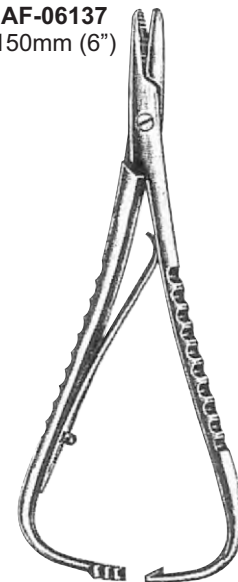

MCPHAILS

AF-06139
180mm (7")



"TC" NEEDLE HOLDERS

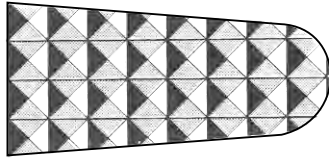

COARSE

For powerful needle holder patterns and wire twisters

Maximum holding capabilities for heavy needles or wire

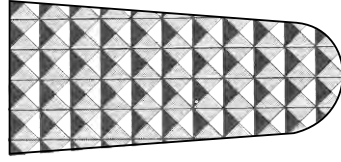

STANDARD

Used for example Mayo-Hegar, Mathieu Needle Holders

For needle 3-0 and larger

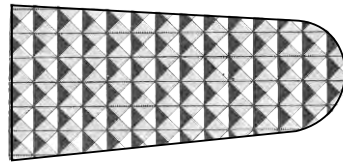

FINE

For delicate needle holders such as Crile Wood and Debakey

For needle and sutures between 4-0 and 6-0

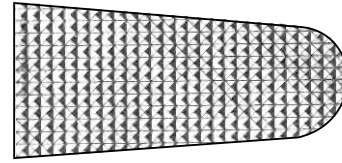

MICRO

For micro needle holder such as Castroviejo, Microvascular and Mini-Ryder

For delicate needle and sutures between 7-0 and 10-0



With Smooth Jaws

CASTROVIEJO

AF-06200
145mm (5 3/4")



02

CASTROVIEJO

AF-06201
145mm (5 3/4")



02

CASTROVIEJO

AF-06202
180mm (7")



02

CASTROVIEJO

AF-06203
215mm (8 1/2")



"TC" NEEDLE HOLDERS

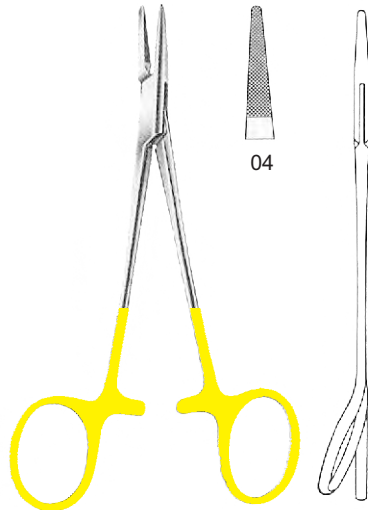

MASING
AF-06204
 130mm (5 1/8")
 One ring angled

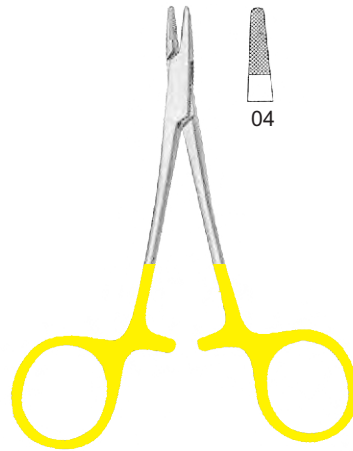

DERF
AF-06205
 115mm (4 1/2")

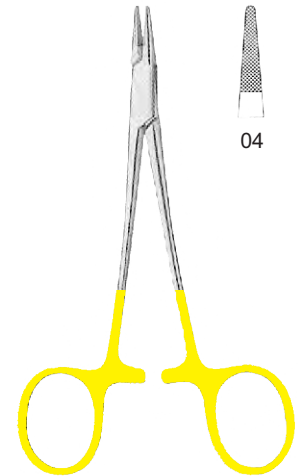

MASING
AF-06206
 125mm (5")



CRILE - WOOD



AF-06207
 180mm
 (7")



AF-06208
 200mm
 (8")



AF-06209
 305mm
 (12 1/4")

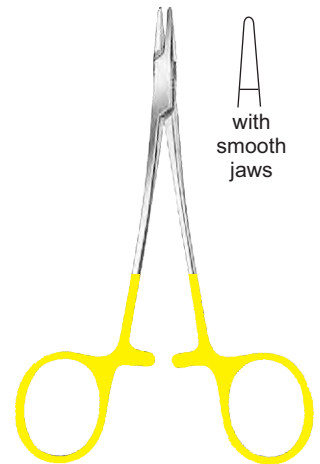

HALSEY
AF-06210
 120mm (4 3/4")
 with smooth jaws

"TC" NEEDLE HOLDERS

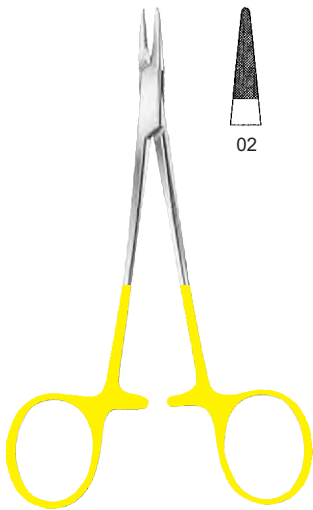

CONVERSE
AF-06211
130mm (51/8")

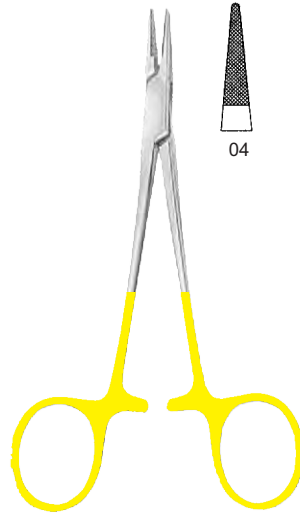

HALSEY
AF-06212
130mm (51/8")

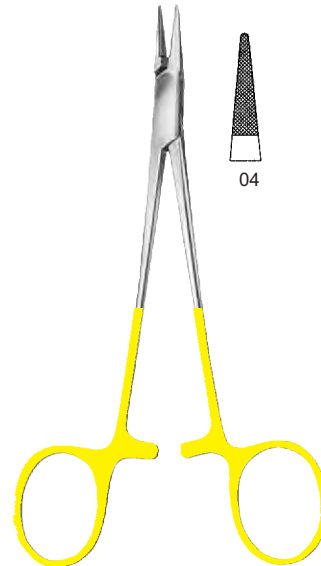

BABY-CRILE-WOOD
AF-06213
150mm (6")



WEBSTER
AF-06214
125mm (5")

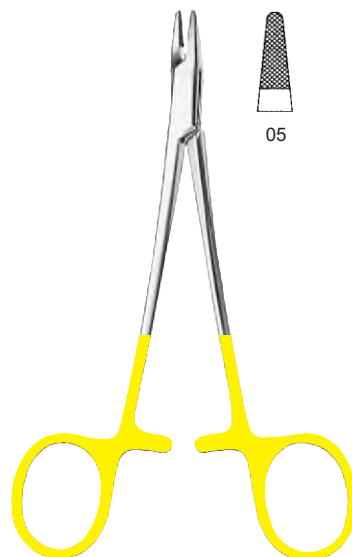

BAUMGARTNER
AF-06215
145mm (53/4")

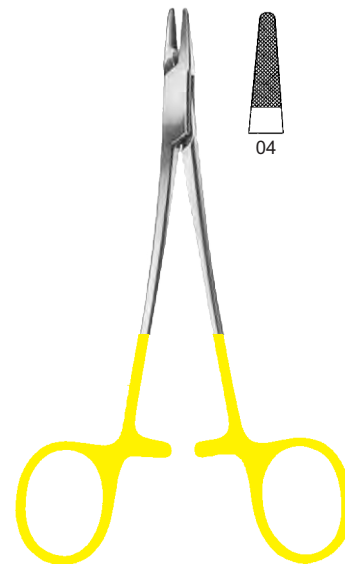

CRILE - WOOD
AF-06216
145mm (53/4")



"TC" NEEDLE HOLDERS

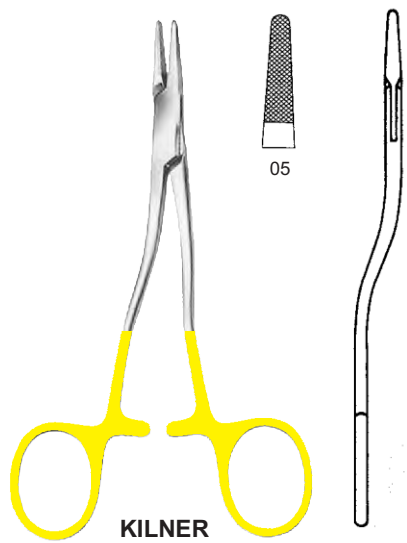

KILNER
AF-06217
 135mm (5 1/4")

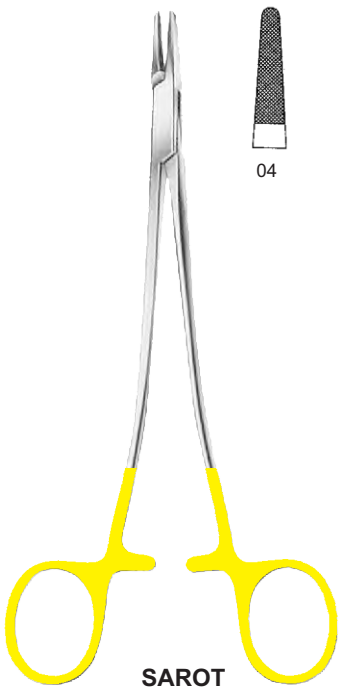

SAROT
AF-06218
 175mm (7")

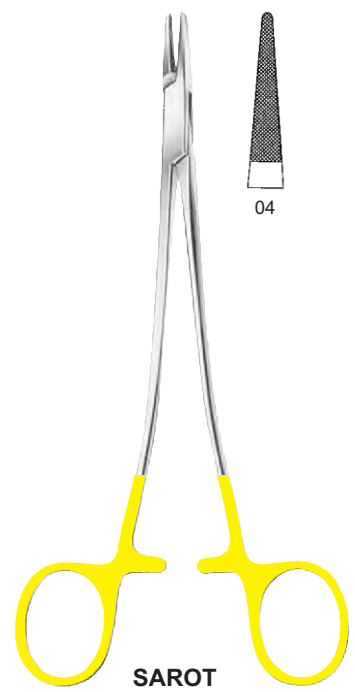

SAROT
AF-06219
 260mm (10 1/4")

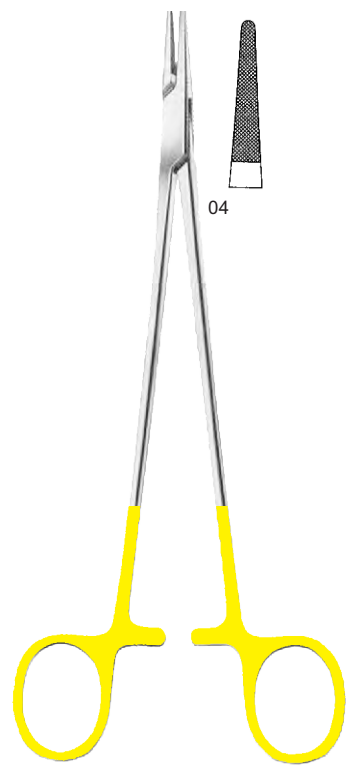

HAGAR-MAYO
AF-06220
 200mm (8")

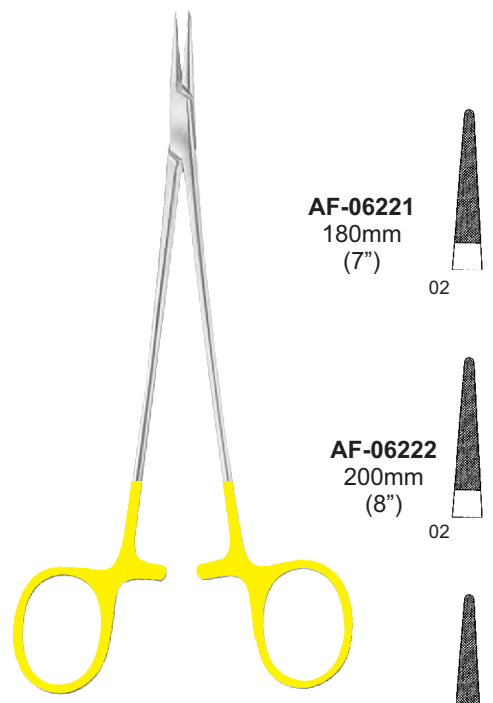

Very Delicate
AF-06223
 230mm (9")

AF-06221
 180mm (7")

AF-06222
 200mm (8")

INSTRUMENTS



"TC" NEEDLE HOLDERS

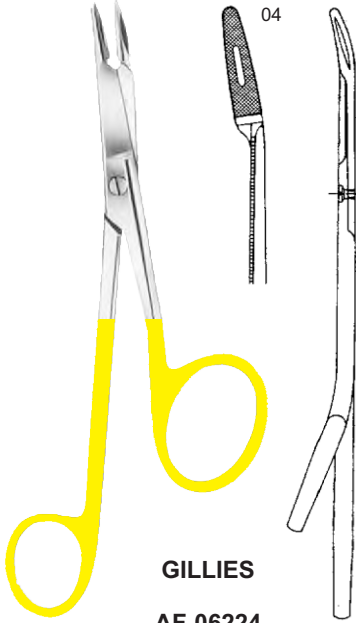

GILLIES
AF-06224
 160mm (6 1/4")

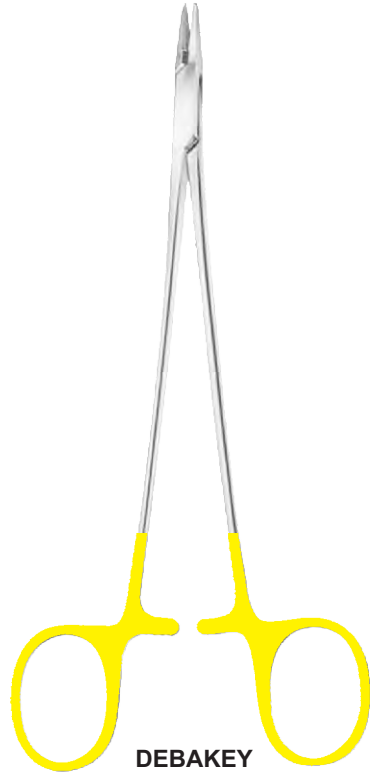

DEBAKEY
 Very Delicate

AF-06225
 165mm (6 1/2")



AF-06226
 210mm (8 1/4")



AF-06227
 165mm (6 1/2")



AF-06228
 210mm (8 1/4")

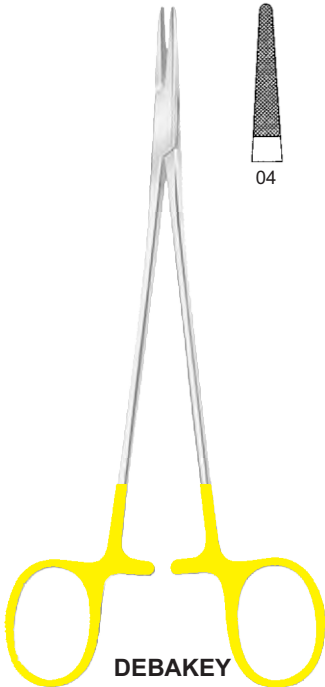
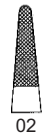

DEBAKEY
AF-06229
 150mm (6")

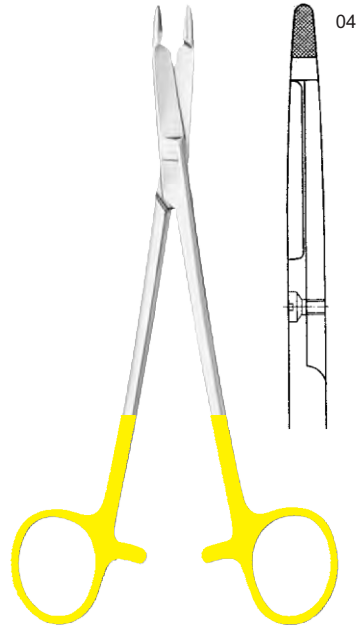

HAGER-OSLEN
AF-06230
 165mm (6 1/2")

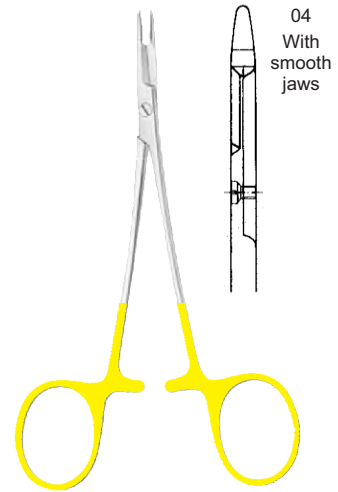

**COMBINED SCISSOR AND
 NEEDLE HOLDER**
AF-06231
 125mm (5")



"TC" NEEDLE HOLDERS

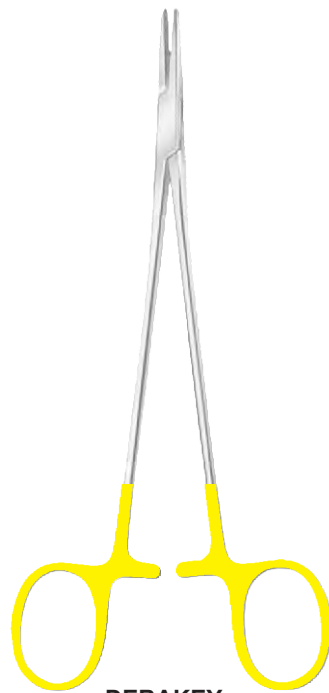

DEBAKEY
Delicate



AF-06232
180mm (7")



AF-06233
230mm (9")



AF-06234
250mm (10")



AF-06235
305mm (12")



"TC" NEEDLE HOLDERS

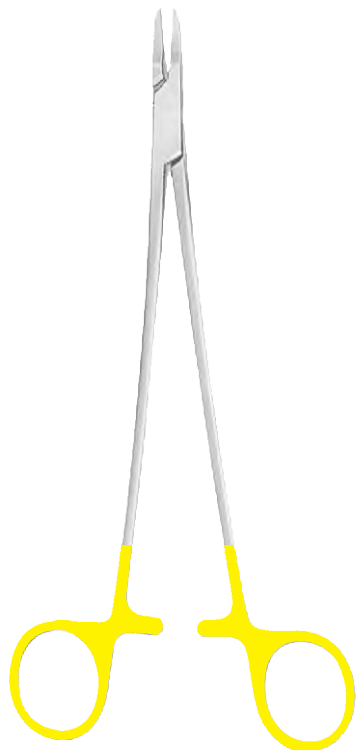

RYDER (FRENCH EYE)



AF-06236
125mm (5")



AF-06237
150mm (6")



AF-06238
180mm (7")



AF-06239
200mm (8")



AF-06240
230mm (9")



AF-06241
250mm (10")



RYDER (MICRO)



AF-06242
125mm (5")



AF-06243
150mm (6")



AF-06244
180mm (7")



AF-06245
200mm (8")



AF-06246
230mm (9")



"TC" NEEDLE HOLDERS

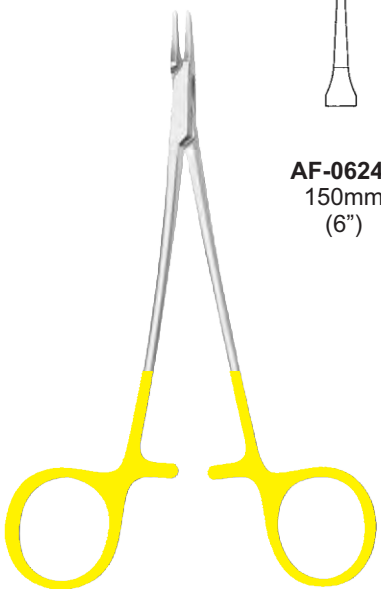

RYDER
With smooth jaw



AF-06247
150mm
(6")



AF-06248
180mm
(7")



AF-0249
230mm
(9")

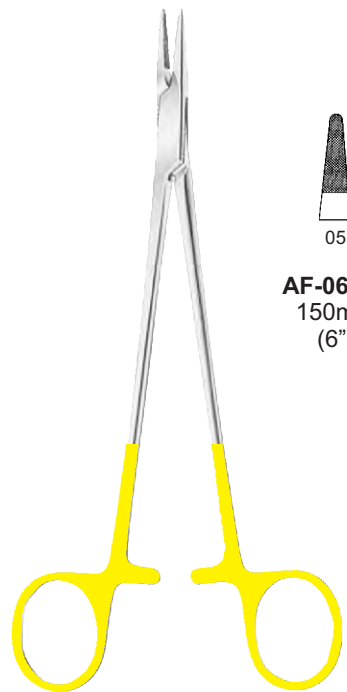

MAYO-HEGAR



AF-06250
150mm
(6")



AF-06251
180mm
(7")



AF-06252
205mm
(8")



MAYO-HEGAR



AF-06253
300mm
(12")

"TC" NEEDLE HOLDERS

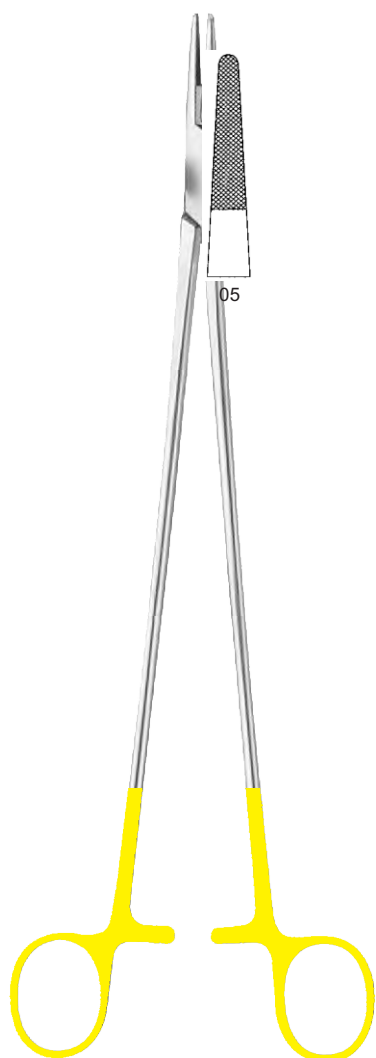

WANGENSTEEN

AF-06254
275mm (103/4")

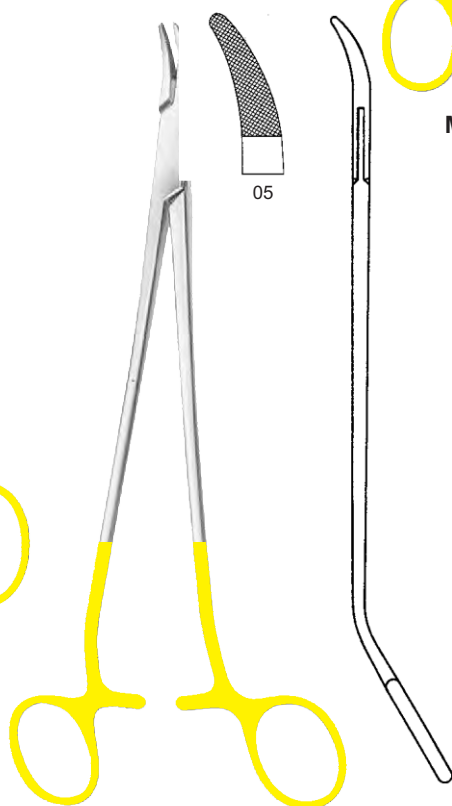

THOMSON-WALKER

AF-06257
215mm (81/2")
S Shaped

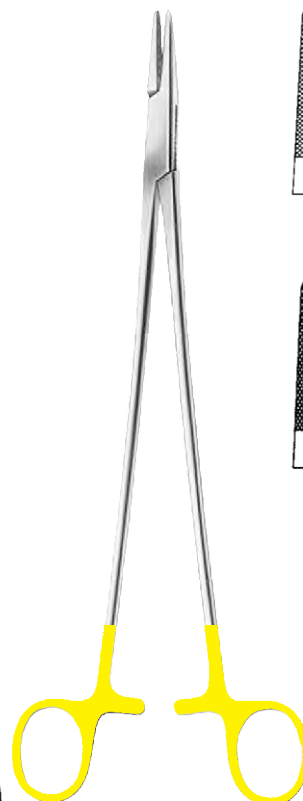

MAYO-HEGAR
Heavy Pattern



AF-06255
205mm (8")



AF-06256
245mm (93/4")



"TC" NEEDLE HOLDERS

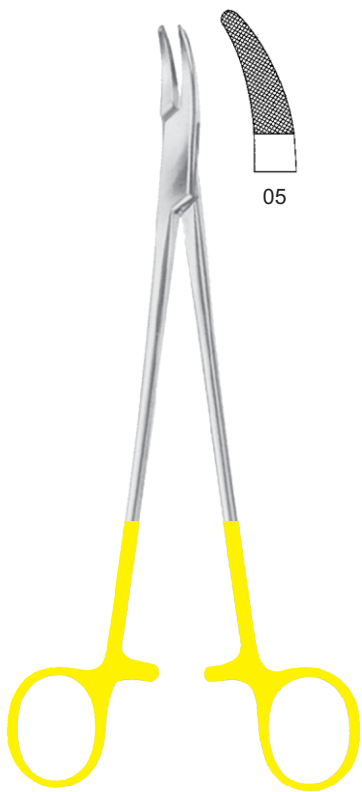

HEANEY

AF-06258
200mm (8")
Curved on flat

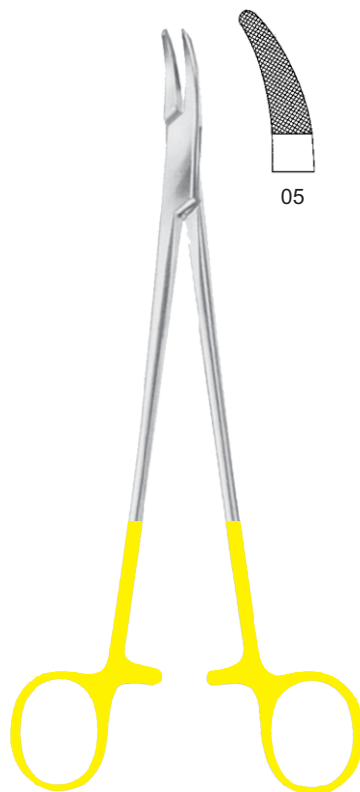

HEANEY

AF-06259
260mm (10 1/4")



NAUNTON MORGAN

AF-06260
260mm (10 1/4")

"TC" NEEDLE HOLDERS

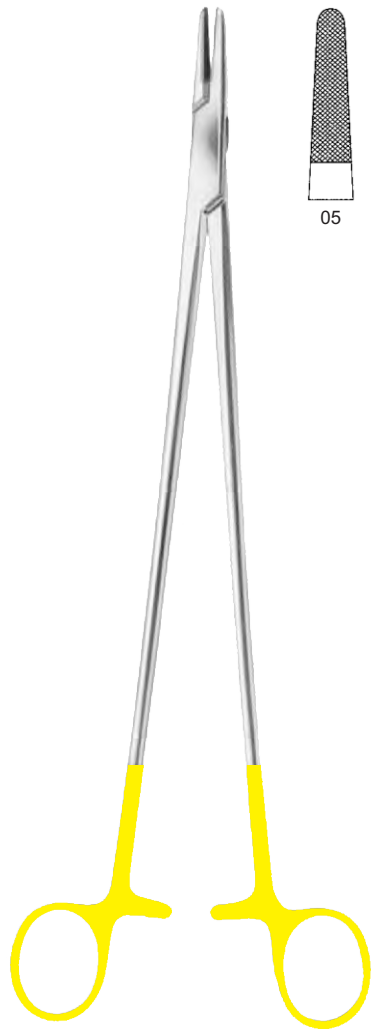

MASSON
AF-06261
265mm (10 1/2")



FINOCHIETTO
AF-06262
265mm (10 1/2")



"TC" NEEDLE HOLDERS

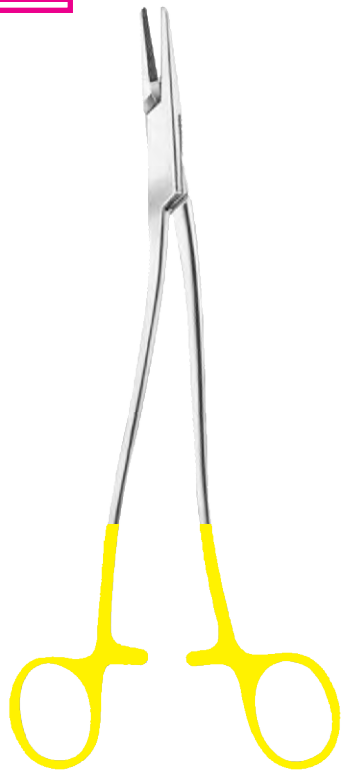

WERTHEIM

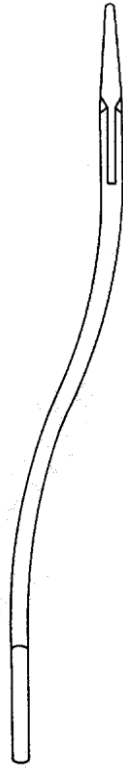

AF-06263
200mm (8")



AF-06264
240mm (9 1/2")



AF-06265
300mm (12")



Wire Twister, Round jaw



AF-06266
150mm
(6")

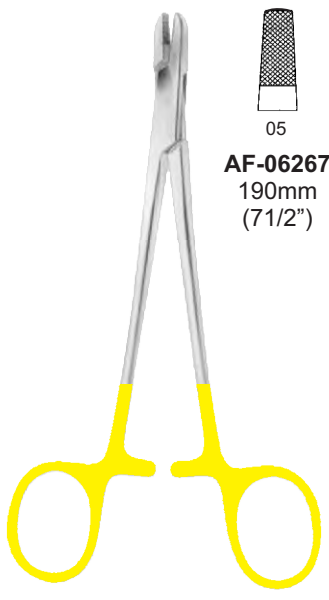

BERRY



AF-06267
190mm
(7 1/2")

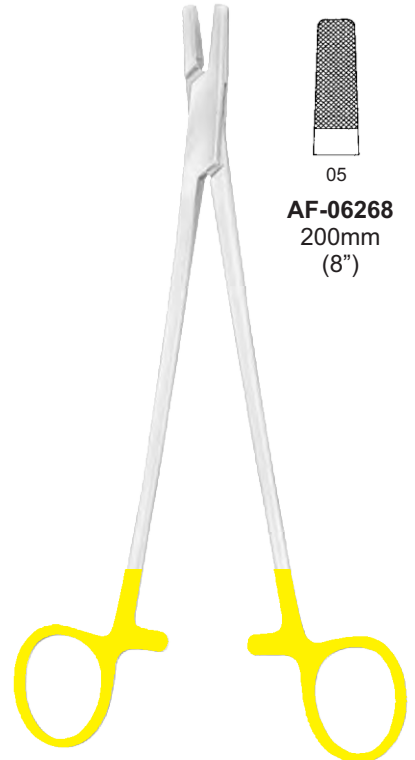

BAUMGARTNER
Wire Twister, Square jaw



AF-06268
200mm
(8")

INSTRUMENTS



"TC" NEEDLE HOLDERS

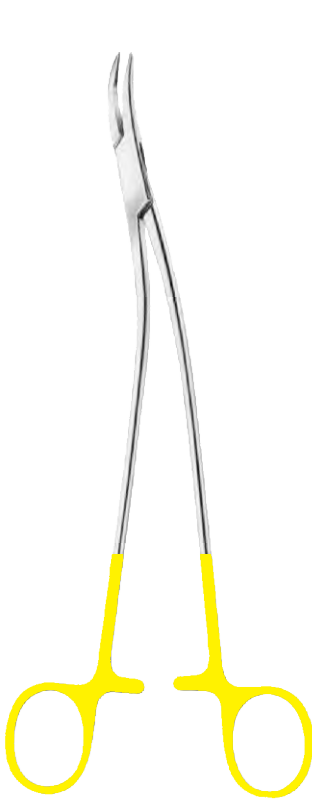

STRATTE

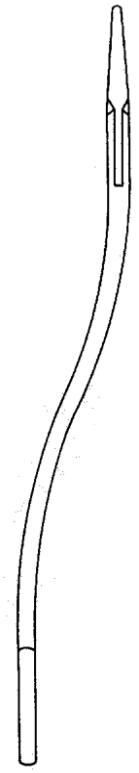

AF-06269
210mm (8 1/4")



AF-06270
230mm (9")



AF-06274
275mm (10 3/4")



MATHIEU
Delicate pattern



AF-06271
200mm (8")

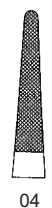

AF-06272
240mm (9 1/2")

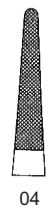

AF-06273
300mm (12")



"TC" NEEDLE HOLDERS



AF-06275
195mm (73/4")
Elastic pattern, delicate



AF-06276
200mm (8")



HOESEL
AF-06280
260mm (101/4")
With long neck



AF-06277
140mm (51/2")

AF-06278
170mm (63/4")

AF-06279
200mm (8")

MATHIEU-STANDARD

INSTRUMENTS



"TC" NEEDLE HOLDERS



ZWEIFEL



05

AF-06281
200mm (8")
Heavy pattern for sternum suture



MATHIEU
Heavy pattern



05

AF-06282
200mm (8")



05

AF-06283
245mm (9 3/4")



04

AF-06284
200mm (8")



With long neck



04

AF-06285
260mm (10 1/4")



ZWEIFEL



05

AF-06286
180mm (7")



05

AF-06287
230mm (9")





"TC" NEEDLE HOLDERS



AF-06288
200mm (8")

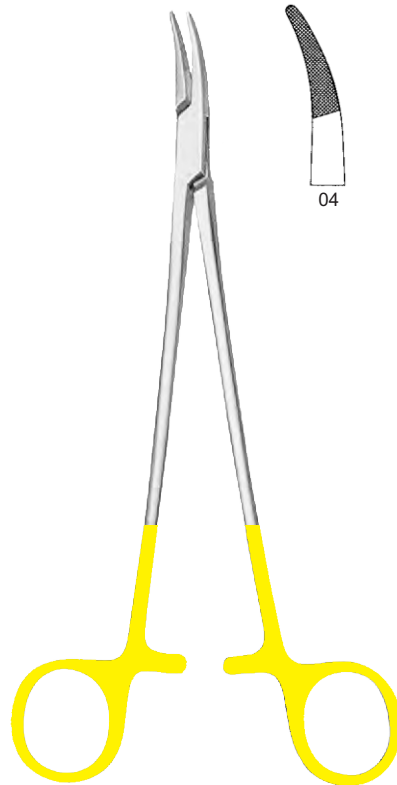

JULIAN
AF-06289
200mm (8")



TOENNIS
AF-06290
185mm (7 1/4")

"TC" NEEDLE HOLDERS



LANGENBECK



05

AF-06291
180mm (7")



05

AF-06292
200mm (8")



04

TOENNIS

AF-06293
180mm (7")
Elastic pattern



"TC" NEEDLE HOLDERS



LAWRANCE

AF-06294
150mm (6")
Lightweight

AF-066295
150mm (6")



LANGENBECK
Delicate



AF-06296
200mm (8")



AF-06297
260mm (10 1/4")

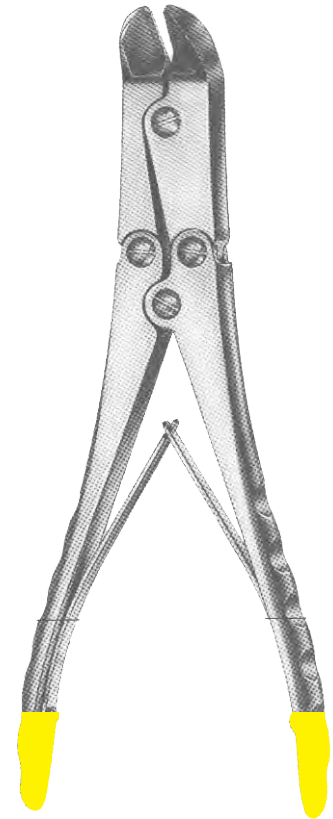

WIRE CUTTER
with tungsten carbide inserts

AF-06298
150mm (6")

AF-06299
200mm (8")

OPHTHALMOLOGY

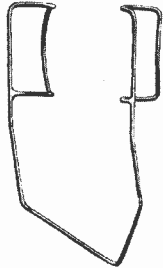

AAD-07100
BARRAQUER
30mm (11/4")
40mm (-3/4")

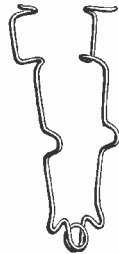

AAD-07101
BOWMAN
70mm (23/4")

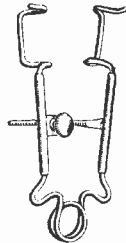

AAD-07102
CRITCHETT
70mm (23/4")

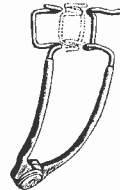

AAD-07103
SMITH
50mm (2")

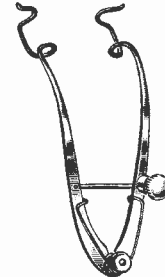

AAD-07104
CLARK
80mm (31/4")

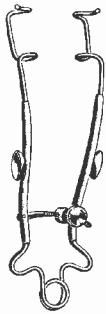

AAD-07105
GRAEFE
70mm (23/4")
90mm (31/2")



AAD-07106
WEEK
80mm (321/4")

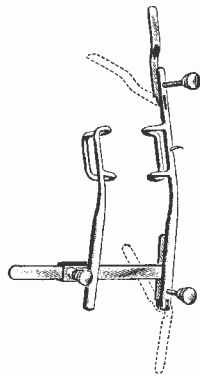

AAD-07107
ARRUGA
70mm (23/4")
Rachts

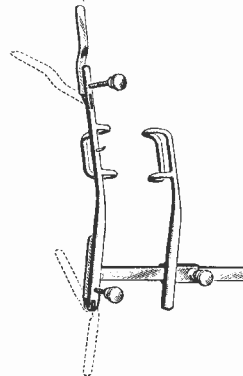

AAD-07108
ARRUGA
70mm (23/4")
Links

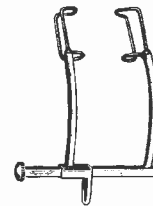

AAD-07109
MURDOCK
50mm (2")

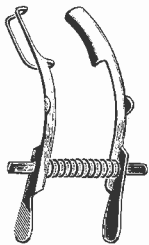

AAD-07110
MELLINGER
AXENFELD
70mm (23/4")

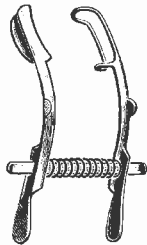

AAD-07111
MELLINGER
AXENFELD
70mm (23/4")

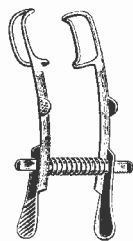

AAD-07112
MELLINGER
50mm (2")
70mm (23/4")

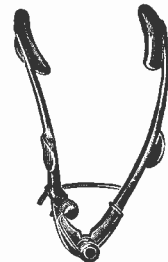

AAD-07113
LISTER BURCH
80mm (31/4")

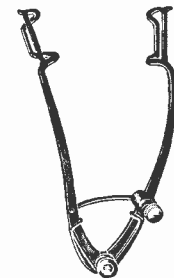

AAD-07114
WILLIAMS
80mm (31/4")



OPHTHALMOLOGY

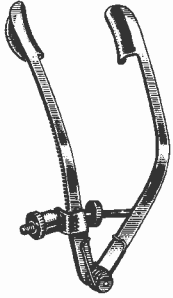

AAD-07115
LANCASTER
70mm (23/4")

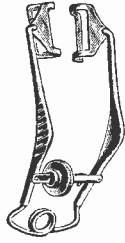

AAD-07116
ZIEGLER
70mm (23/4")



AAD-07117
CASTROVIEJO
80mm (31/4")

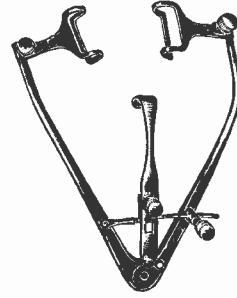

AAD-07118
PARK
80mm (31/4")



AAD-07119
MUELLER
70mm (23/4")

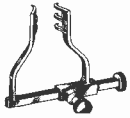

AAD-07120
GOLDSTEIN
30mm (11/4")

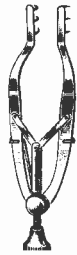

AAD-07121
STEVENSON
70mm (23/4")



AAD-07122
JAEGER
110mm (41/2")



GRAEFE



AAD-07123
Fig 0



AAD-07124
Fig 1



AAD-07125
Fig 2



AAD-07126
Fig 3



AAD-07127
DEUTSCHMANN
130mm (51/4")



OPHTHALMOLOGY

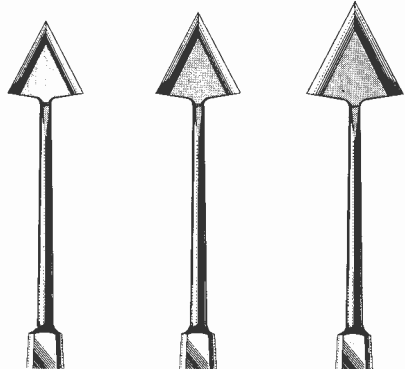
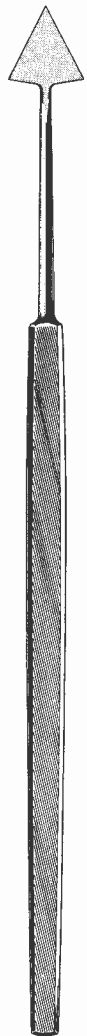

JAEGER

AAD-07128 Fig 1 AAD-07129 Fig 2 AAD-07130 Fig 3

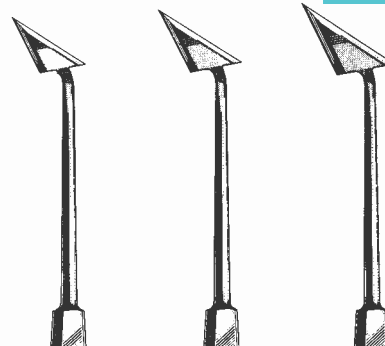

JAEGER 45°

AAD-07131 Fig 1 AAD-07132 Fig 2 AAD-07133 Fig 3

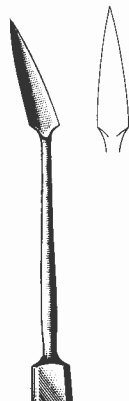

AAD-07134
BERENS
130mm (5 1/4")

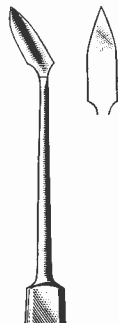

AAD-07135
CASTROVIEJO
130mm (5 1/4")



AAD-07136
GRAEFE
130mm (5 1/4")



AAD-07137
Fig 1



AAD-07138
Fig 2



AAD-07139
Fig 3

KNAPP



ZIEGLER

AAD-07140
Fig 1
5mm



AAD-07141
Fig 2
6mm



AAD-07142
Fig 3
7mm



AAD-07143
DEAN
125mm(5")



BOWMAN

AAD-07144
04mm
130mm (5 1/4")



AAD-07145
08mm
130mm (5 1/4")















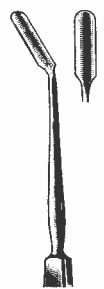













AAD-07146
WHEELER
120mm (4 3/4")





OPHTHALMOLOGY

						
AAD-07147 ZIEGLER 110mm (4 1/2")	AAD-07148 SATO 125mm (5")	AAD-07149 TOOK 120mm (4 3/4")	AAD-07150 GILL 120mm (4 3/4")	AAD-07151 ELSCHING 130mm (5 1/4")	AAD-07152 KUHNT Fig 1	
						
AAD-07153 KUHNT Fig 2	AAD-07154 KUHNT Fig 3	AAD-07155 KUHNT Fig 4	AAD-07156 PATON 120mm (4 3/4")	AAD-07157 LUNDSGAARD 120mm (4 3/4")	AAD-07158 GUYTON LUNDSGAARD	AAD-07159 BARRKAN
						
AAD-07160 SCHEIE	AAD-07161 BURCH	AAD-07162 PAUFIQUE	AAD-07163 BARRAQUER	AAD-07164	AAD-07165	
						
AAD-07166 BOWMAN	AAD-07167 BOWMAN	AAD-07168	AAD-07169	AAD-07170 LEVINSON	AAD-07171 FRANCIS	AAD-07172 DAVIS 130mm (5 1/4")

INSTRUMENTS

OPHTHALMOLOGY



AAD-07173
LA FORCE



AAD-07174
DIX

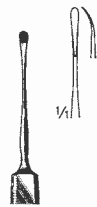

AAD-07175
ELLIS



AAD-07176
WALTON



AAD-07177
WALTON



AAD-07178
ALVIS

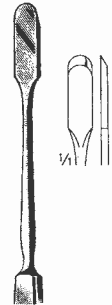

AAD-07179
GREEN



AAD-07180
ROLLET



AAD-07181
Fig 1



AAD-07182
Fig 2



AAD-07183
Fig 3



AAD-07184
JAMESON



AAD-07185
GREEN



AAD-07186
STEVENS



AAD-07187
Fig 1

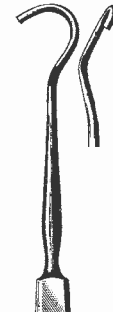

AAD-07188
Fig 2



AAD-07189
O'CONNOR



AAD-07190
WIENER



AAD-07191
WIENER



AAD-07192
ROLLET

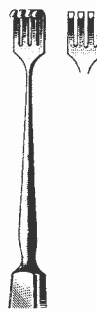

AAD-07193
KNAPP



AAD-07194



AAD-07195
GRAEFE



AAD-07196



AAD-07197
BECKER



OPHTHALMOLOGY

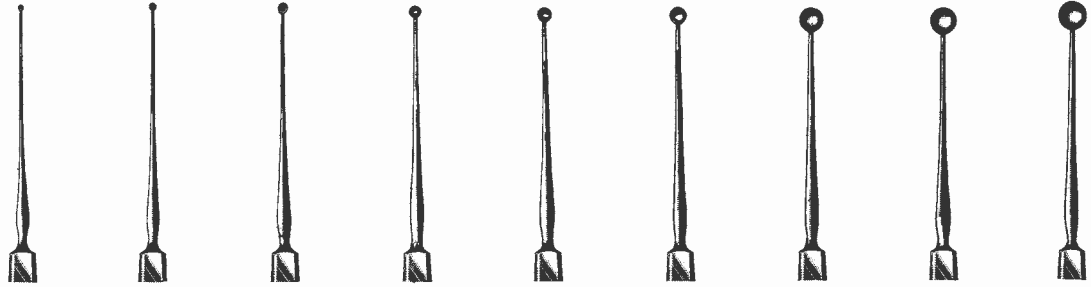

MEYHOEFER

- | | | | | | | | | |
|-----------|-----------|-----------|-----------|-----------|-----------|-----------|-----------|-----------|
| AAD-07198 | AAD-07199 | AAD-07200 | AAD-07201 | AAD-07202 | AAD-07203 | AAD-07204 | AAD-07205 | AAD-07206 |
| 05 Ømm | 10 Ømm | 15 Ømm | 18 Ømm | 20 Ømm | 25 Ømm | 35 Ømm | 40 Ømm | 45 Ømm |

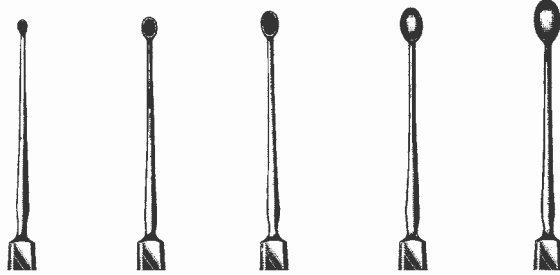

MEYHOEFER

- | | | | | |
|-----------|-----------|-----------|-----------|-----------|
| AAD-07207 | AAD-07208 | AAD-07209 | AAD-07210 | AAD-07211 |
| 10 Ømm | 20 Ømm | 25 Ømm | 30 Ømm | 35 Ømm |



AAD-07212
AXENFELD

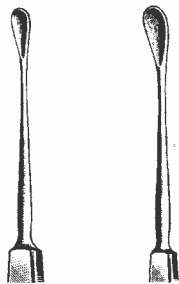

GRAEFE

- | | |
|-----------|-----------|
| AAD-07213 | AAD-07214 |
|-----------|-----------|

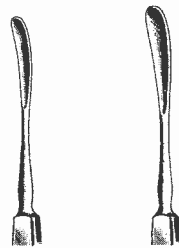

GRAEFE

- | | |
|-----------|-----------|
| AAD-07215 | AAD-07216 |
|-----------|-----------|



AAD-07217
KNAPP

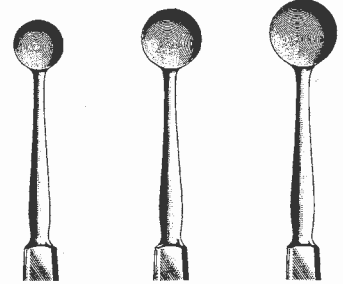

BUNGE

- | | | |
|-----------|-----------|-----------|
| AAD-07218 | AAD-07219 | AAD-07220 |
|-----------|-----------|-----------|

INSTRUMENTS



OPHTHALMOLOGY



AAD-07221
LANG

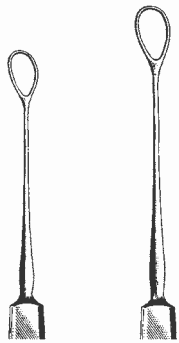

WEBER
AAD-07222 Fig1 AAD-07223 Fig2



AAD-07224
SNELLEN

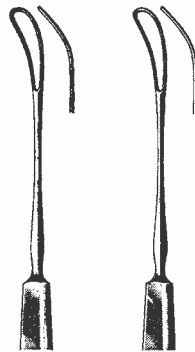

WILDER
AAD-07225 Fig1 AAD-07226 Fig2

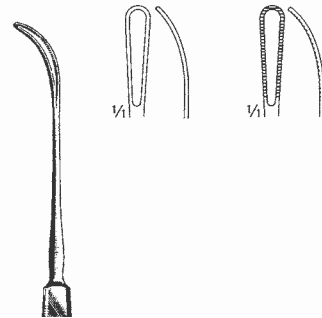

ARLT
AAD-07227 AAD-07228

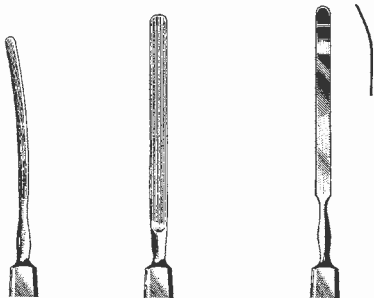

WECKER
AAD-07229 AAD-07230

AAD-07231
CULLER

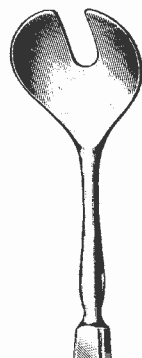

AAD-07232
WELLS



AAD-07233
ARRUGA

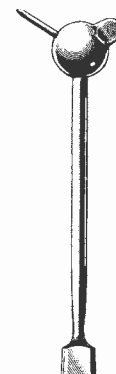

AAD-07234
WADSWORTH
TODD

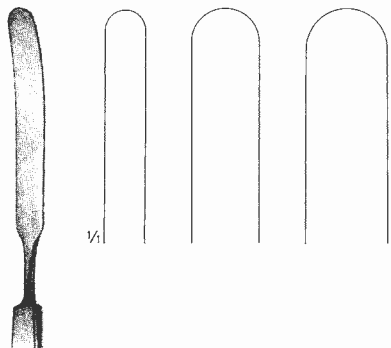

BANGERTER
AAD-07235 6mm AAD-07236 10mm AAD-07237 12mm



AAD-07238

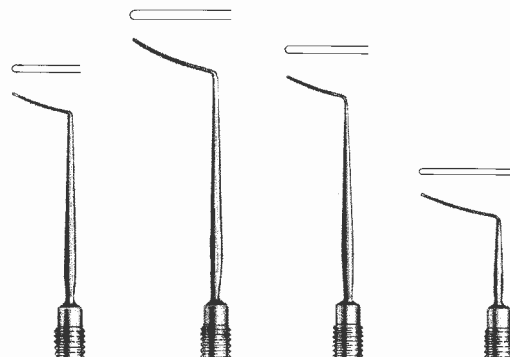

CASTROVIEJO
AAD-07239 12 x 10mm AAD-07240 15 x 15mm AAD-07241 12 x 12mm AAD-07242 08 x 15mm





OPHTHALMOLOGY

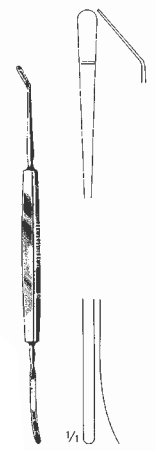

AAD-07243
CASTROVIEJO

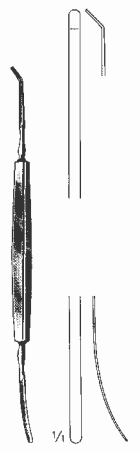

AAD-07244
WHEELER



AAD-07245
CASTROVIEJO
0mm, 075mm, 10mm

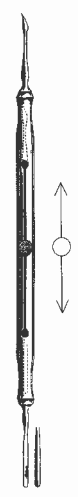

AAD-07246
DIX

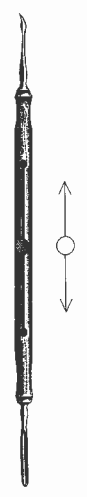

J8-0AAD-0
DIX



AAD-07248
DIX

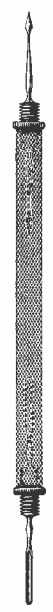

AAD-07249
DIX

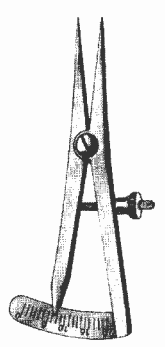

AAD-07250
CASTROVIEJO



AAD-07251
CONNIN-AMSLER



AAD-07252
DASTOOR
60mm (2 1/2")

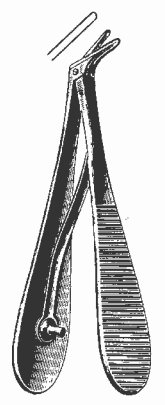

AAD-07253
HOLTH

INSTRUMENTS



OPHTHALMOLOGY

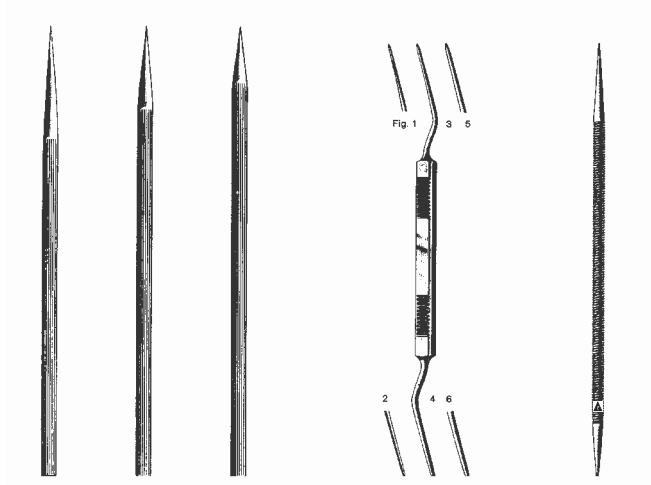

WILDER
AAD-07254 AAD-07255 AAD-07256

AAD-07257
ZIEGLER
Fig 1/2
Fig 3/4
Fig 5/6

AAD-07258
CASTROVIEJO

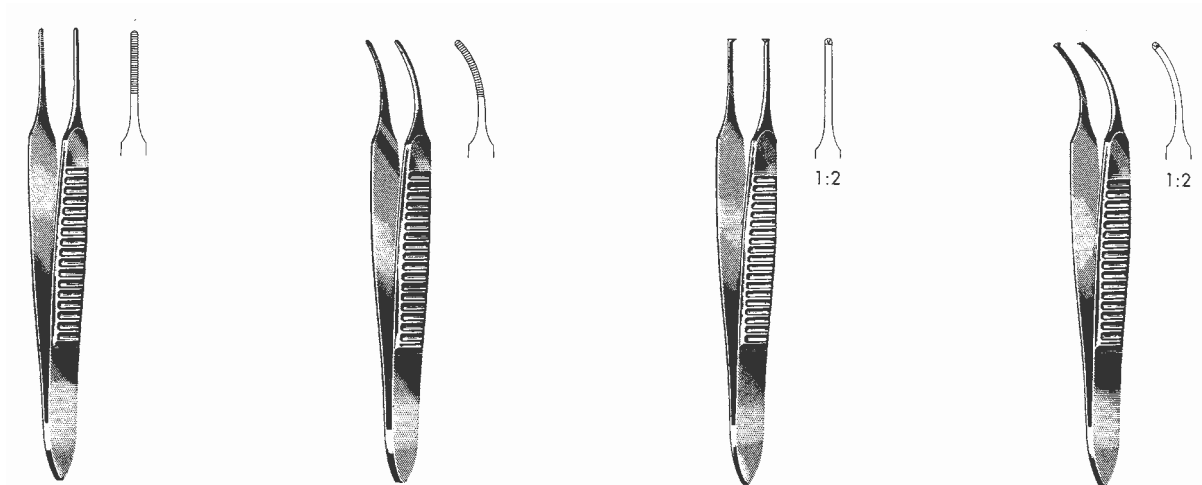

AAD-07259
GRAEFE
70mm/1mm, (23/4")

AAD-07260
GRAEFE
70mm/1mm, (23/4")

AAD-07261
GRAEFE
70mm/1mm, (23/4")

AAD-07262
GRAEFE
70mm/1mm, (23/4")



IRIS FORCEPS



AAD-07263
GRAEFE
70mm (23/4")
100mm (4")



AAD-07264
GRAEFE
70mm (23/4")
100mm (4")

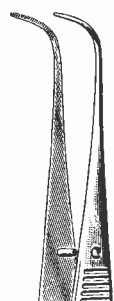

AAD-07265
GRAEFE
70mm (23/4")
100mm (4")



AAD-07266
GRAEFE
70mm (23/4")
100mm (4")

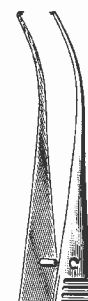

AAD-07267
GRAEFE
70mm (23/4")
100mm (4")



AAD-07268
GRAEFE
70mm (23/4")
100mm (4")



AAD-07269
STEVENS
105mm (4 1/4")



AAD-07270
STEVENS
105mm (4 1/4")

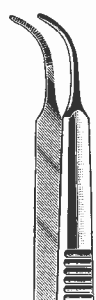

AAD-07271
STEVENS
105mm (4 1/4")



AAD-07272
STEVENS
105mm (4 1/4")

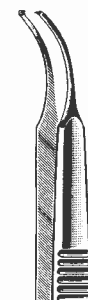

AAD-07273
STEVENS
105mm (4 1/4")



AAD-07274
STEVENS
105mm (4 1/4")

INSTRUMENTS



IRIS FORCEPS

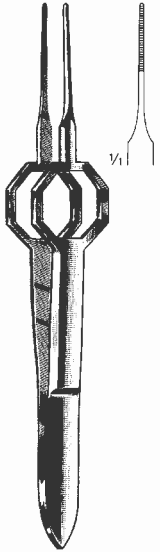

AAD-07275
FOERSTER
85mm (3 1/2")

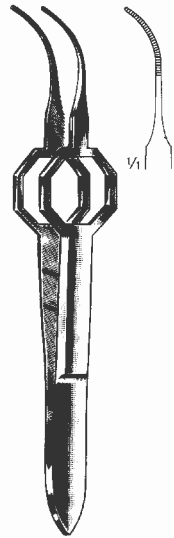

AAD-07276
FOERSTER
85mm (3 1/2")

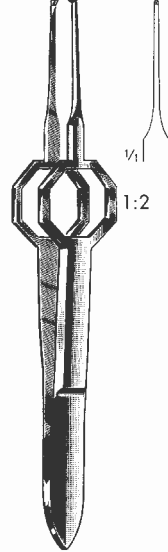

AAD-07277
FOERSTER
85mm (3 1/2")

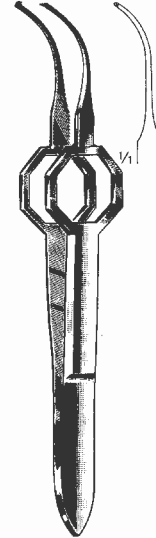

AAD-07278
FOERSTER
85mm (3 1/2")

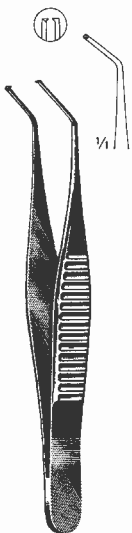

AAD-07279
HESS
70mm (2 3/4")
03mm

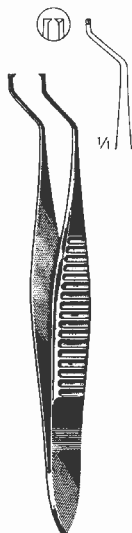

AAD-07280
HESS
70mm (2 3/4")
03mm

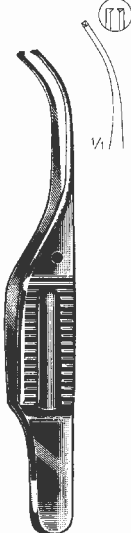

AAD-07281
GILL
75mm (3")
03mm

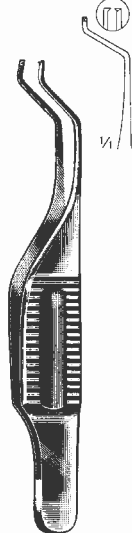

AAD-07282
GILL-HESS
75mm (3")
03mm

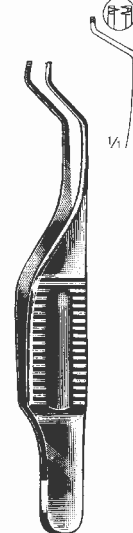

AAD-07283
GILL-HESS
75mm (3")



OPHTHALMOLOGY

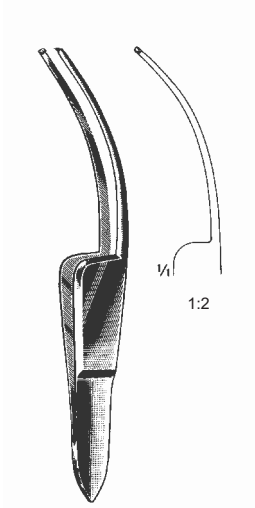

AAD-07284
FISCHER
70mm (23/4")

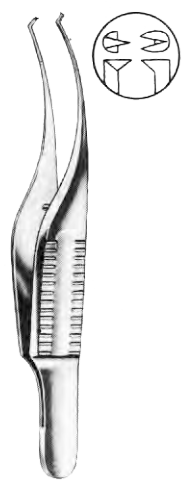

AAD-07285
BARRAQUER-KATZIN
70mm (23/4")
04mm



AAD-07286
TROUTMAN (Colobri)
70mm (23/4")
012mm

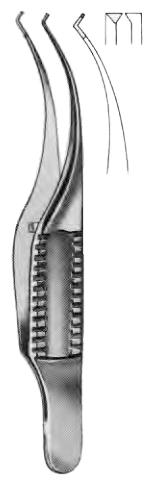

AAD-07287
BARRAQUER (Colobri)
70mm (23/4")
012mm

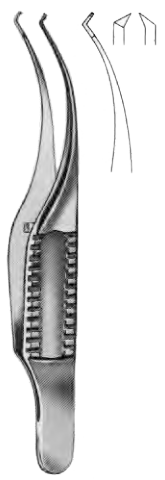

AAD-07288
BARRAQUER (Colobri)
70mm (23/4")
012mm



AAD-07289
KIRBY-ARTHUR
90mm (33/4")
02mm



AAD-07290
KIRBY-ARTHUR
90mm (33/4")
02mm

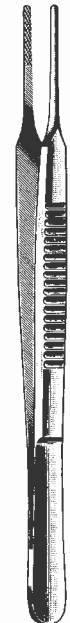

AAD-07291
McCULLOUGH
95mm (33/4")

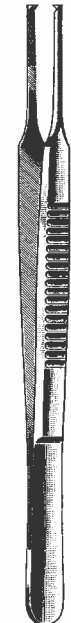

AAD-07292
McCULLOUGH
95mm (33/4")

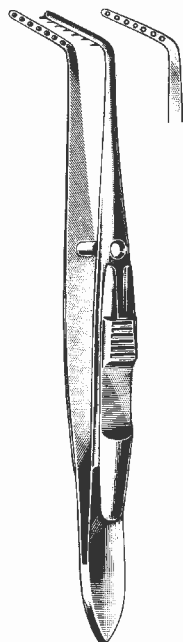

AAD-07293
JAMESON
L, 100mm (4")

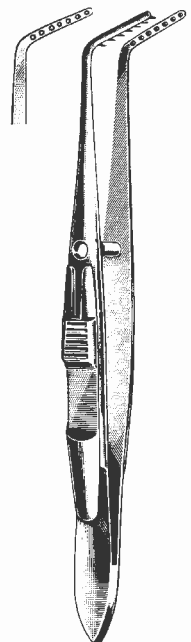

AAD-07294
JAMESON
R, 100mm (4")

INSTRUMENTS

OPHTHALMOLOGY



AAD-07295
BONACCOLTO
100mm (4")



AAD-07296
BONACCOLTO
100mm (4")

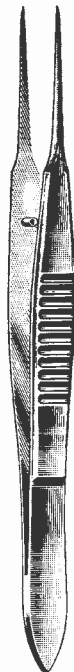

AAD-07297
BONACCOLTO
110mm (4 1/4")

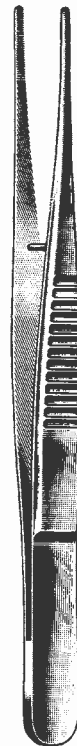

AAD-07298
DASTOOR
110mm (4 1/4")

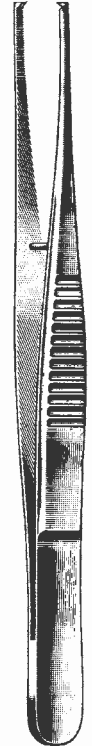

AAD-07299
DASTOOR
110mm (4 1/4")

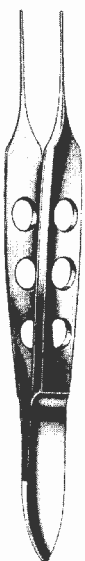

AAD-07300
BISHOP
85mm (3 1/2")
05mm



AAD-07301
BISHOP
85mm (3 1/2")
08mm



AAD-07302
BISHOP
85mm (3 1/2")
05mm



AAD-07303
BISHOP
85mm (3 1/2")
08mm



AAD-07304
Mod BONN
70mm (2 3/4")
012mm



AAD-07305
Mod BONN
70mm (2 3/4")
012mm





OPHTHALMOLOGY

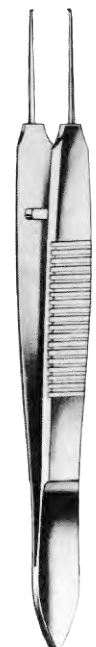

AAD-07306
Mod BONN
100mm (4"), 012mm



AAD-07307
Mod TUBINGEN
100mm (4")



AAD-07308
Mod BONN
100mm (4"), 012mm



AAD-07309
Mod TUBINGEN
100mm

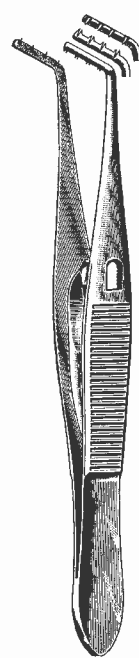

AAD-07310
PRINCE
100mm (4")

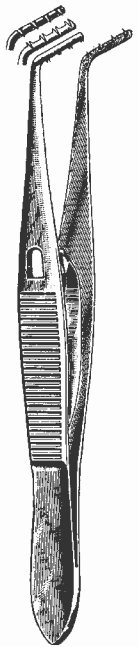

AAD-07311
PRINCE
100mm (4")

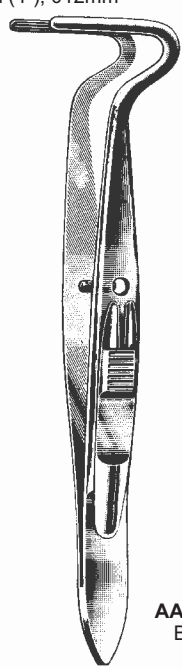

AAD-07312
BERKE

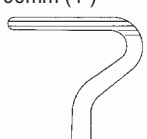

AAD-07312

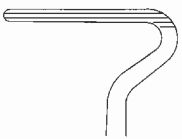

AAD-07313



AAD-07314
TROUTMAN
85mm (31/2")
08mm

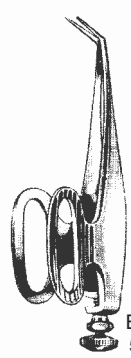

AAD-07315
7mm

AAD-07315
BARRAQUER
55mm (21/4")

INSTRUMENTS



OPHTHALMOLOGY



AAD-07316
ELSCHING
110mm (5-1/4")



AAD-07317
GRAEFE



AAD-07318
LESTER



AAD-07319
CASTROVIEJO

1:1

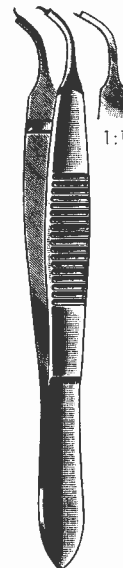

AAD-07320
CASTROVIEJO

1:1



AAD-07321
CASTROVIEJO

2:2

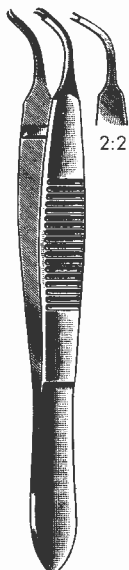

AAD-07322
CASTROVIEJO

2:2

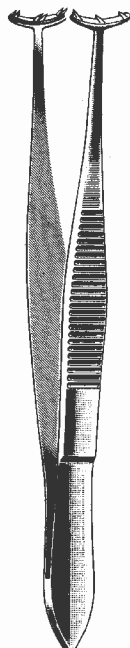

AAD-07323
BARRAQUER
100mm (4")

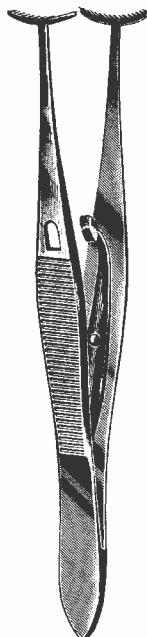

AAD-07324
GREEN
100mm (4")



AAD-07325
5mm



AAD-07326
10mm



AAD-07327
5mm



AAD-07328
10mm

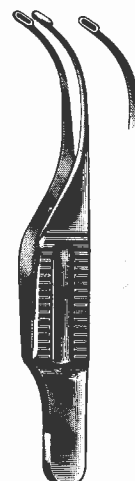

AAD-07329
GILL ARRUGA
75mm (3")





CAPSULAR FORCEPS

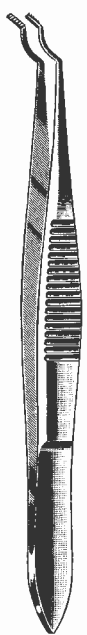

AAD-07330
TERSON
90mm (33/4")

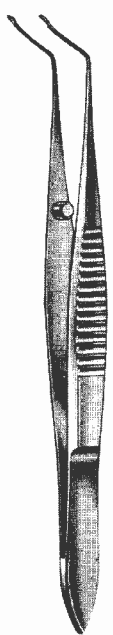

AAD-07331
KALT
100mm (4")

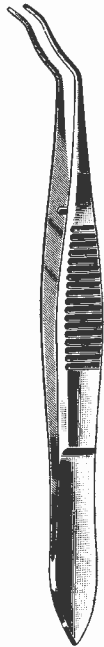

AAD-07332
ELSCHING
100mm (4")

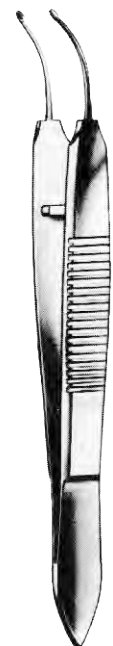

AAD-07333
ARRUGA
100mm (4")

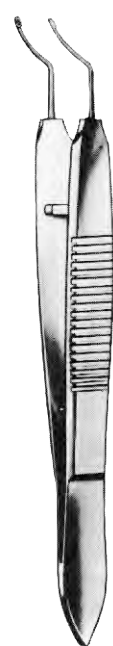

AAD-07334
ARRUGA
100mm (4")



AAD-07335
CASTROVIEJO
100mm (4")

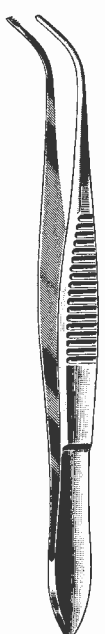

AAD-07336
SCHWEIGGER
100mm (4")



AAD-07337
SCHWEIGGER
100mm (4")

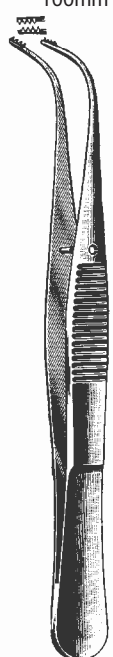

AAD-07338
ELSCHNIG
100mm (4")

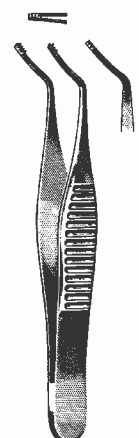

AAD-07339
HESS
60mm (21/2")

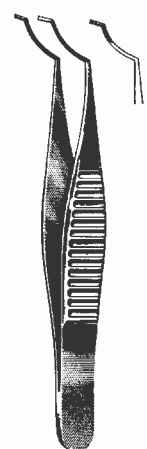

AAD-07340
HESS
65mm (21/2")

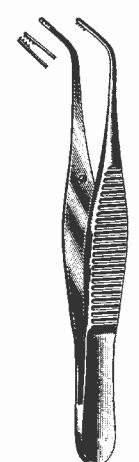

AAD-07341
FUCHS
70mm (23/4")

INSTRUMENTS

OPHTHALMOLOGY

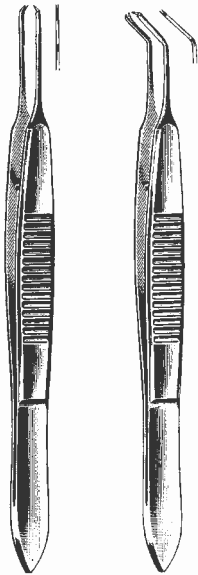

AAD-07342
CASTROVIEJO
012mm, 030mm, 05mm, 100mm, 15mm



AAD-07343
MOORFIELD
100mm (4")



AAD-07344
St MARTIN
70mm (23/4")

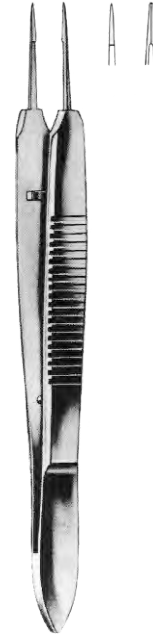

AAD-07345
Mod TUBINGEN
100mm (4")



AAD-07346
PAUFIQUE
85mm (31/2")



AAD-07347
PAUFIQUE
85mm (31/2")



AAD-07348
McPHERSON
100mm (4")



AAD-07349
McPHERSON
100mm (4")



OPHTHALMOLOGY

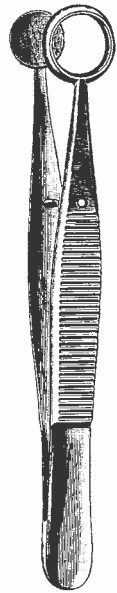

J18-07350
AYER
90mm (33/4")

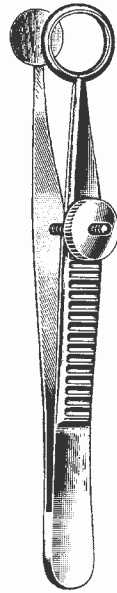

AAD-07351
AYER
90mm (33/4")

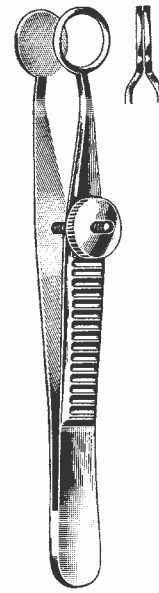

AAD-07352
LAMBERT
90mm (33/4")

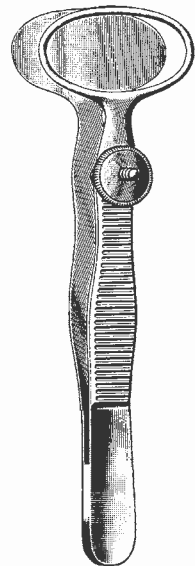

AAD-07353
DESMARRES
90mm (33/4")

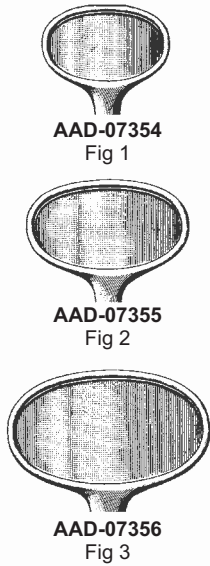

AAD-07354
Fig 1

AAD-07355
Fig 2

AAD-07356
Fig 3

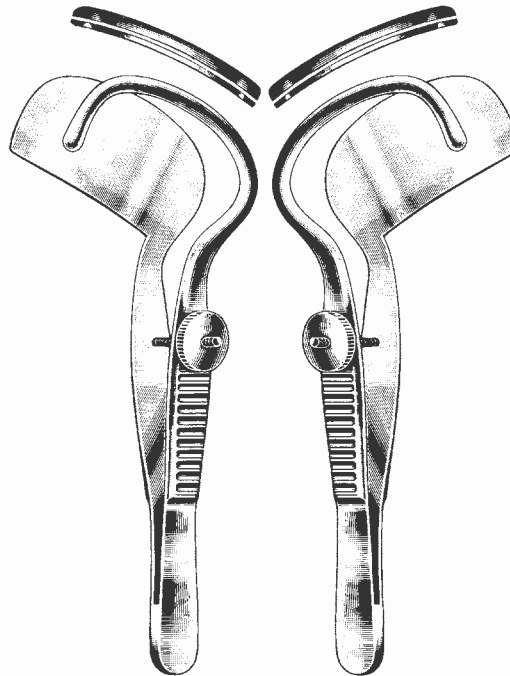

AAD-07357
SNELLEN
100mm (4")

AAD-07358
SNELLEN
100mm (4")

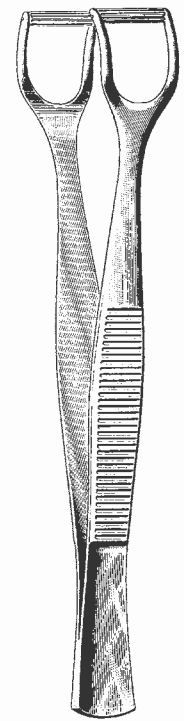

AAD-07359
KNAPP-LUER
110mm (41/4")

INSTRUMENTS

PROBES

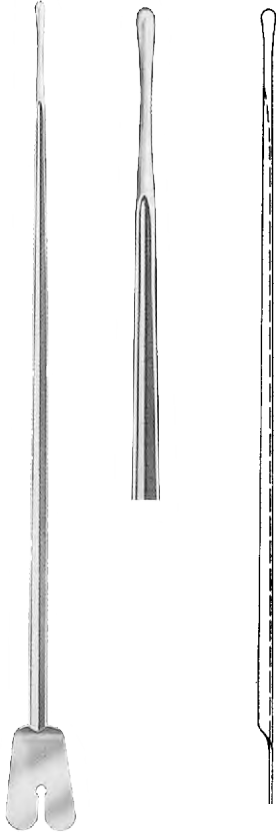

BRODIE

AB-07500
200mm (8")
Ball point

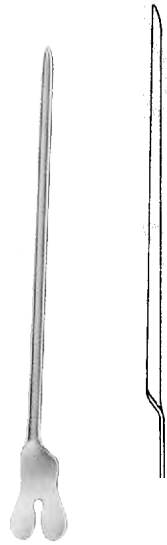

DIRECTORS

AB-07501
130mm (5 1/8")

AB-07502
145mm (5 3/4")

AB-07503
160mm (6 1/4")

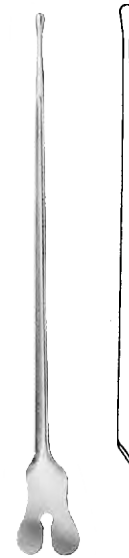

AB-07504
140mm (5 1/2")



PROBES



SINUS
AB-07505
150mm (6")



PROBE
With Eye

PROBE

AB-07506
127mm (5")

AB-07507
152mm (6")

AB-07508
178mm (7")

AB-07509
200mm (8")

AB-07510
255mm (10")

AB-07511
305mm (12")



MYRTLE LEAF PROBE
AB-07512
145mm (53/4")



1mm Tip
AB-07513
145mm (53/4")

15mm tip

2mm tip

AB-07514
130mm (51/8")

AB-07520
145mm (53/4")

AB-07515
145mm (53/4")

AB-07521
160mm (61/4")

AB-07516
160mm (61/4")

AB-07522
180mm (7")

AB-07517
180mm (7")

AB-07523
200mm (8")

AB-07518
200mm (8")

AB-07519
250mm (10")

PROBES



LIEBRICH LACHRYMAL

AB-07528
No 00 - 0 (07 - 08mm)

AB-07529
No 1 - 2 (09 - 11mm)

AB-07530
No 3 - 4 (13 - 14mm)

AB-07531
No 5 - 6 (15 - 16mm)



ANEL LACHRYMAL

AB-07532
108mm (4 1/4") 06mm , small



JOBSON HORNE

K3-07534
140mm (5 1/2")

K3-07535
178mm (7")



CAWTHORNE

K3-07533
140mm (5 1/2")



PROBES



**KINGS COLLEGE HOSPITAL
COCAINISING WIRE**

AB-07536
89mm (3 1/2")

AB-07537
133mm (5 1/4")



LOGAN TURNER

AB-07538
120mm (4 3/4")
100mm diameter



FISTULA PROBE

AB-07539
240mm (9 1/2")

DISSECTORS

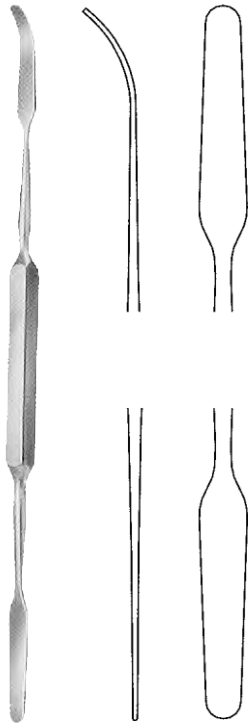

MACDONALD

AH-07600
185mm (7 1/4")
Double ended



WATSON CHEYNE
Fine with probe

AH-07601
125mm (5")

AH-07602
190mm (7 1/2")

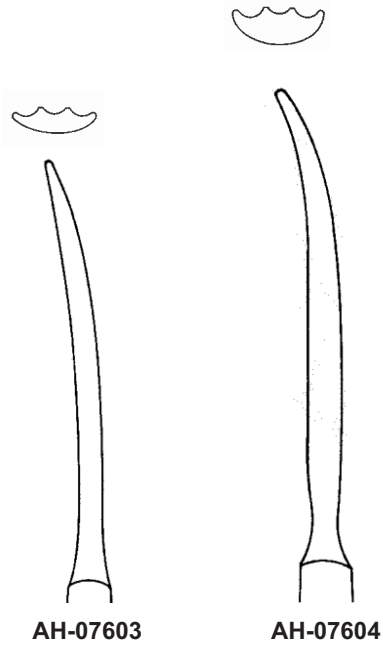

AH-07603

AH-07604



KOCHER THYROID

AH-07603
150mm(6")

AH-07604
170mm (6 3/4")



DISSECTORS

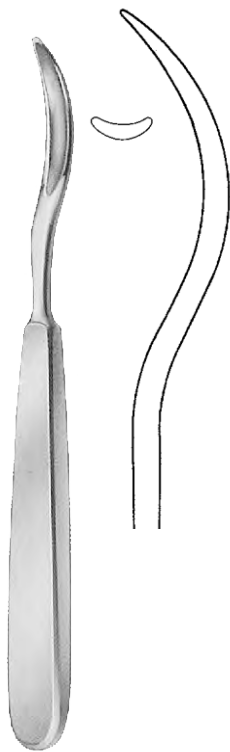

KOCHER THYROID

AH-07605
190mm (7 1/2")

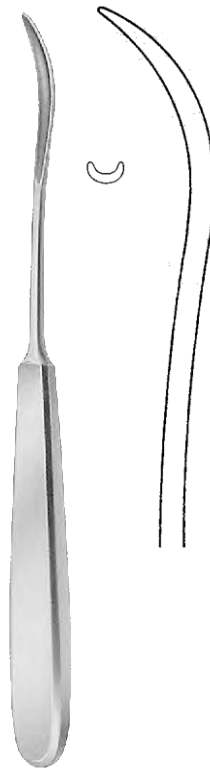

KING

AH-07606
195mm (7 3/4")

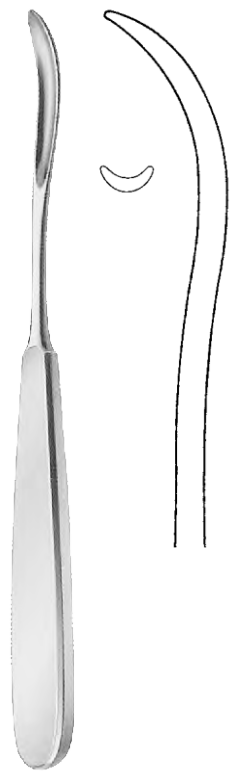

KING

AH-07607
200mm (8")

DISSECTORS

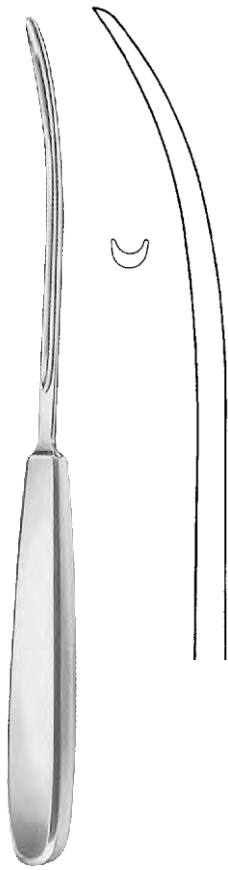

PAYR
AH-07608
225mm (9")

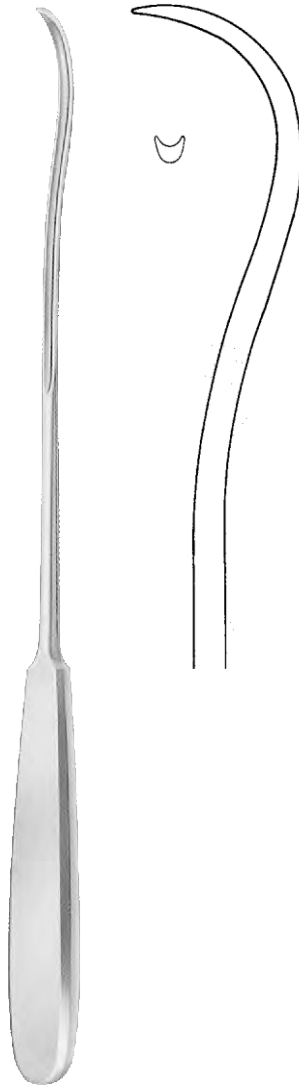

PAYR
AH-07609
280mm (11")



GWYNNE EVANS TONSIL
200mm (8")
Double ended

AH-07610
6mm wide

AH-07611
8mm wide



RETRACTOR



HURD PILLAR RETRACTOR AND TONSIL

AH-07612
197mm
Double ended

MOLLINSON ANTERIOR PILLAR RETRACTOR AND TONSIL DISSECTOR

AH-07613
210mm (8 1/4")
Double ended

SYME TONSIL

AH-07614
180mm (7")
Double ended, one blunt
one semi - sharp

SUTURE INSTRUMENTS



MICHEL

AG-07700
125mm (5")
Applying forceps



MICHEL

AG-07701
125mm (5")
Applying and extracting forceps

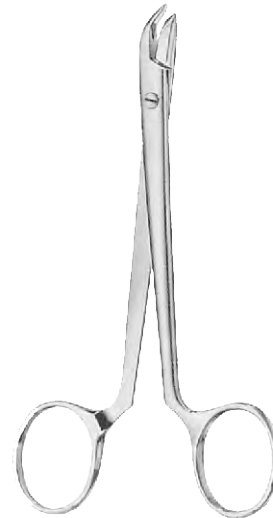

MICHEL

AG-07702
135mm (5 1/4")
Extracting forceps

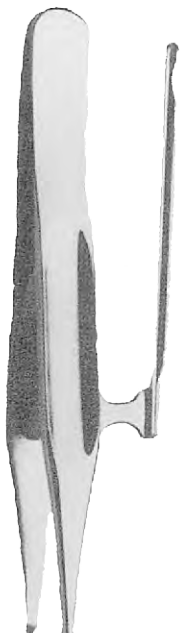

BONNEY

AG-07703
150mm (6")
Upward rack

AG-07704
150mm (6")
Downward rack

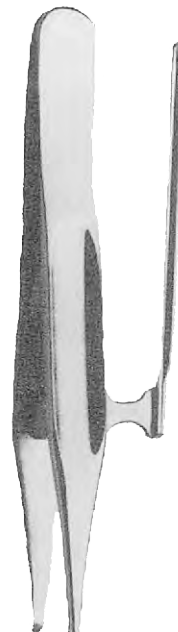

CHILDES

AG-07705
180mm (7")
Upward rack

AG-07706
180mm (7")
Upward rack
fenestrated

AG-07707
180mm (7")
Downward rack



SUTURE INSTRUMENTS

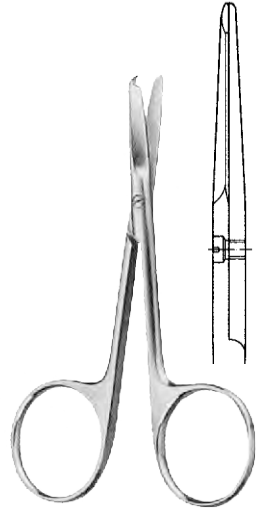

LITTAUER
AG-07708
 110mm (4 1/2")
 With hook end

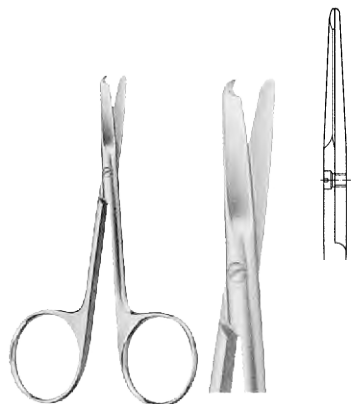

LITTAUER (SPENCER)
AG-07709
 80mm (3 1/2")
 With hook end



CHARNLEY SUTURE FORCEPS

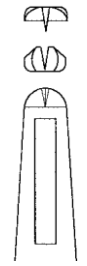

AG-07713
 180mm (7")

AG-07714
 125mm (5")



MILLIN "BOOMERANG"
AG-07710
 230mm (9")
 With two needles



AG-07711



AG-07712

MILLIN NEEDLE
AG-07711
 Small
AG-07712
 Large



MICHEL CLIPS
AG-07715
 12mm
 Single, Small
 Pack of 100



AG-07716
 14mm
 Single, medium
 pack of 100
AG-07717
 16mm
 Single, large
 Pack of 100
AG-07718
 12mm
 Double teeth
 Pack of 100

INSTRUMENTS



ANEURYSM NEEDLES

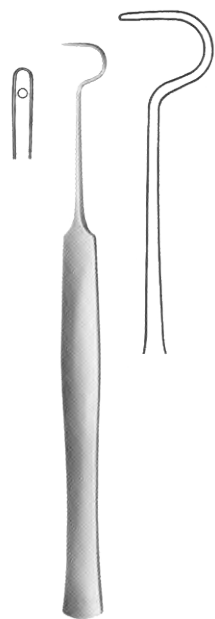

**SMALL ANEURYSM
NEEDLE**

PB-07719
150mm (6")

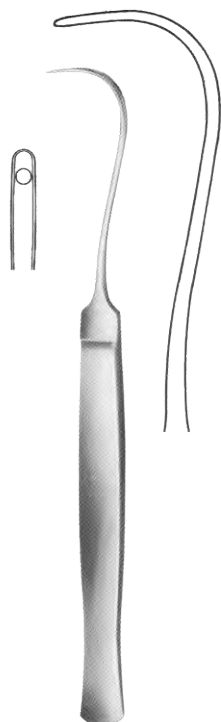

SYME

PB-07720
170mm (6 3/4")



DESCHAMPS

PB-07721
215mm (8 1/2")
For right hand, blunt



DESCHAMPS

PB-07722
215mm (8 1/2")
For left hand, blunt





ANEURYSM NEEDLES



DESCHAMPS
PB-07723
210mm (8 1/4")
For right hand, blunt



DESCHAMPS
PB-07724
210mm (8 1/4")
For left hand, blunt

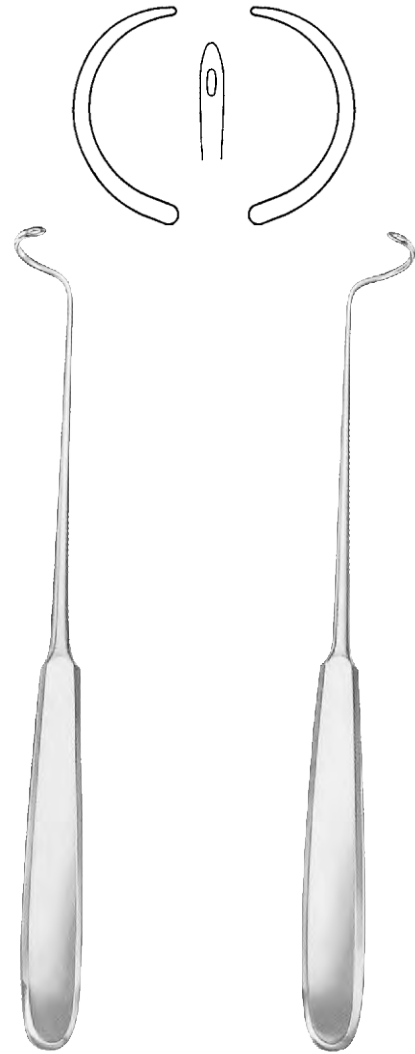

DESCHAMPS
PB-07725
215mm (8 1/2")
For right hand, blunt

DESCHAMPS
PB-07726
215mm (8 1/2")
For left hand, blunt



ANEURYSM NEEDLES



DESCHAMPS

PB-07727
230mm (9")
Malleable



HAND HELD RETRACTORS



DEAVER
AN-07800
215mm (8 1/2")
Blade: 22mm wide

DEAVER
AN-07801
235mm (9 1/4")
Blade: 25mm wide

HAND HELD RETRACTORS



DEAVER

AN-07802
300mm (12")
Blade: 25mm wide

DEAVER

AN-07803
315mm (12 1/2")
Blade: 25mm wide



HAND HELD RETRACTORS



DEAVER
AN-07805
300mm (12")
Blade: 38mm wide

DEAVER
AN-07806
310mm (12 1/4")
Blade: 50mm wide

DEAVER
AN-07807
320mm (12 3/4")
Blade: 75mm wide

HAND HELD RETRACTORS



DEAVER GRIP

No 1
AN-07808
310mm (12 1/4")
Blade: 25mm wide



DEAVER GRIP

No 2
AN-07809
310mm (12 1/4")
Blade: 38mm wide



HAND HELD RETRACTORS



DEAVER GRIP

No 3
AN-07810
302mm (12")
Blade: 50mm wide



DEAVER GRIP

No 4
AN-07811
310mm (12 1/4")
Blade: 75mm wide

HAND HELD RETRACTORS



RICHARDSON
240mm (9 1/2")

AN-07812
Blade: 23mm x 20mm

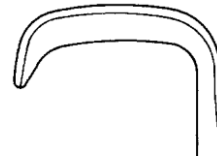

AN-07813
Blade: 30mm x 29mm

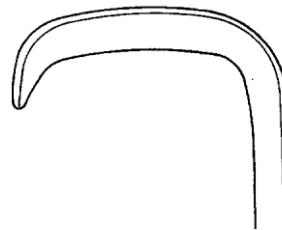

AN-07814
Blade: 37mm x 37mm

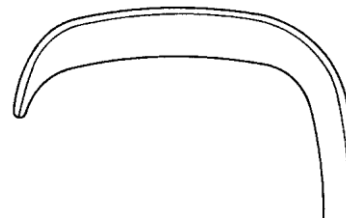

AN-07815
Blade: 47mm x 21mm

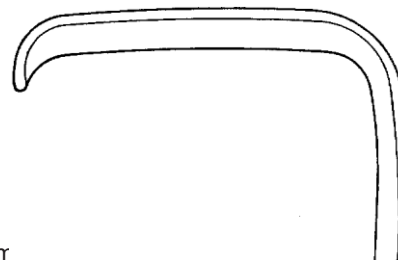



HAND HELD RETRACTORS

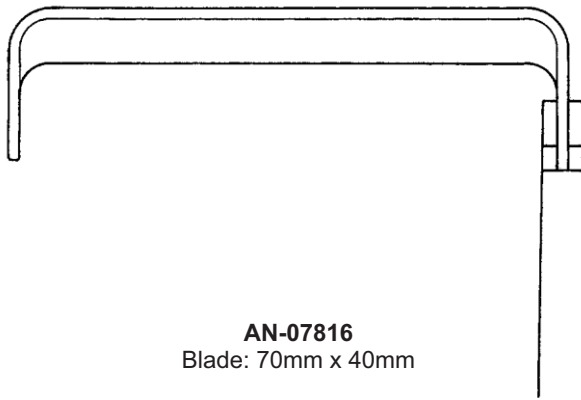

AN-07816
Blade: 70mm x 40mm

AN-07817
Blade: 70mm x 50mm

AN-07818
Blade: 70mm x 65mm



MORRIS
245mm (9 3/4")
Single blade

HAND HELD RETRACTORS

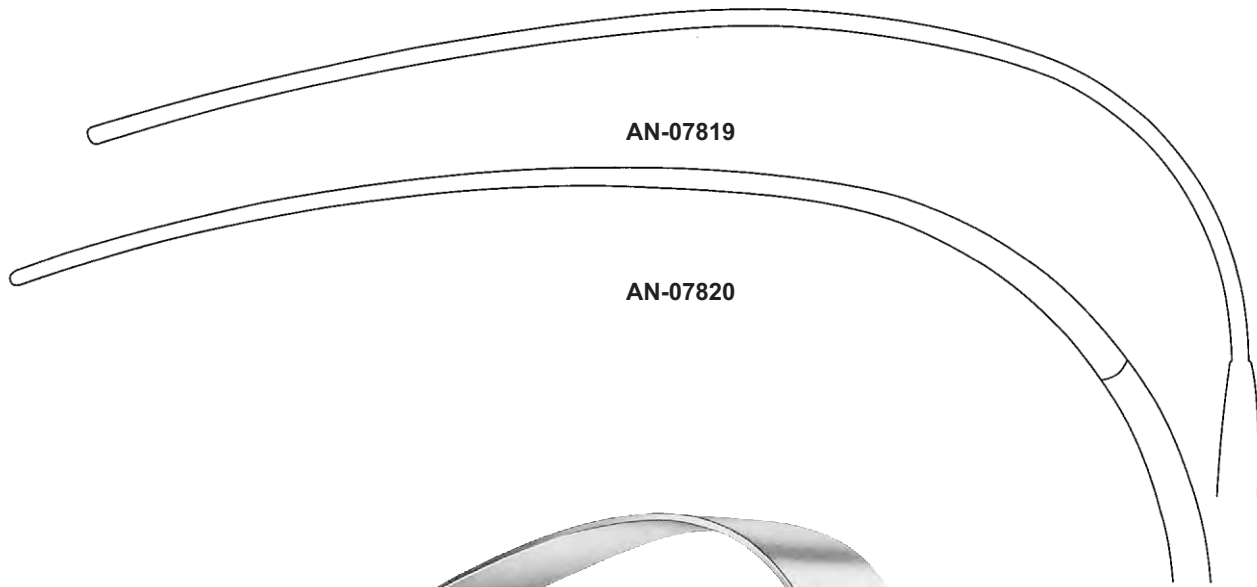

AN-07819

AN-07820

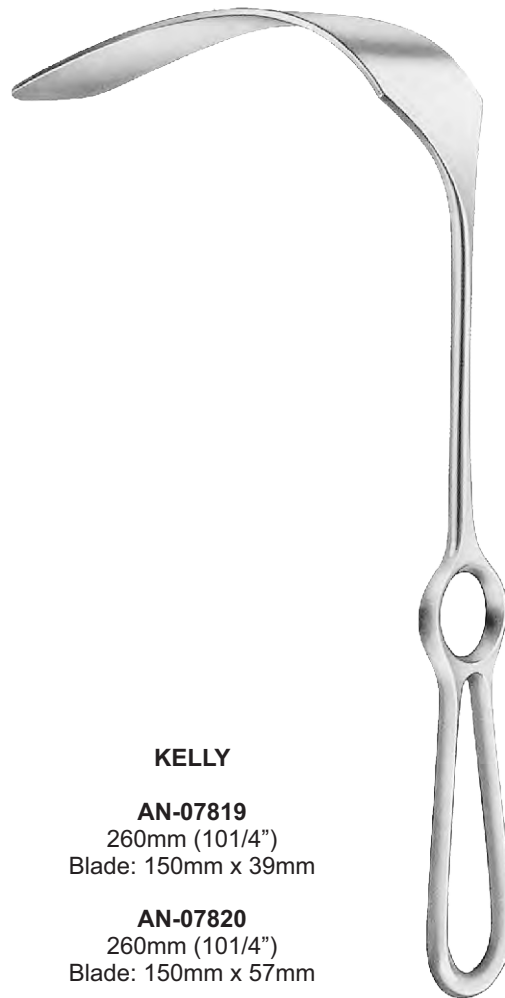

KELLY

AN-07819
260mm (10 1/4")
Blade: 150mm x 39mm

AN-07820
260mm (10 1/4")
Blade: 150mm x 57mm



HAND HELD RETRACTORS



AN-07822



AN-07821



LIVER RETRACTORS 250mm (10")

AN-07821
Blade: 91mm x 35mm

AN-07822
Blade: 121mm x 50mm

INSTRUMENTS

HAND HELD RETRACTORS



AN-07823
220mm (83/4")
Blade: 15mm x 15mm

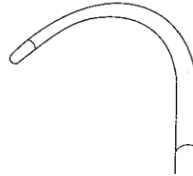

AN-07824
215mm (81/2")
Blade: 20mm x 22mm

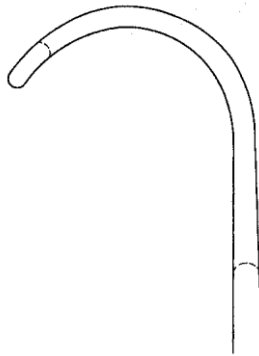

AN-07825
235mm (91/4")
Blade: 28mm x 28mm

MIDDELDORPF



DURHAM
215mm (81/2")

AN-07826
Blade: 10mm

AN-07827
Blade: 16mm



HAND HELD RETRACTORS



MOYNIHAN
205mm (8")

AN-07828
Blade: 20mm x 15mm

AN-07829
Blade: 20mm x 12mm



AN-07828



AN-07829



KOCHER

AN-07830
230mm (9")
Blade: 36mm x 20mm

HAND HELD RETRACTORS

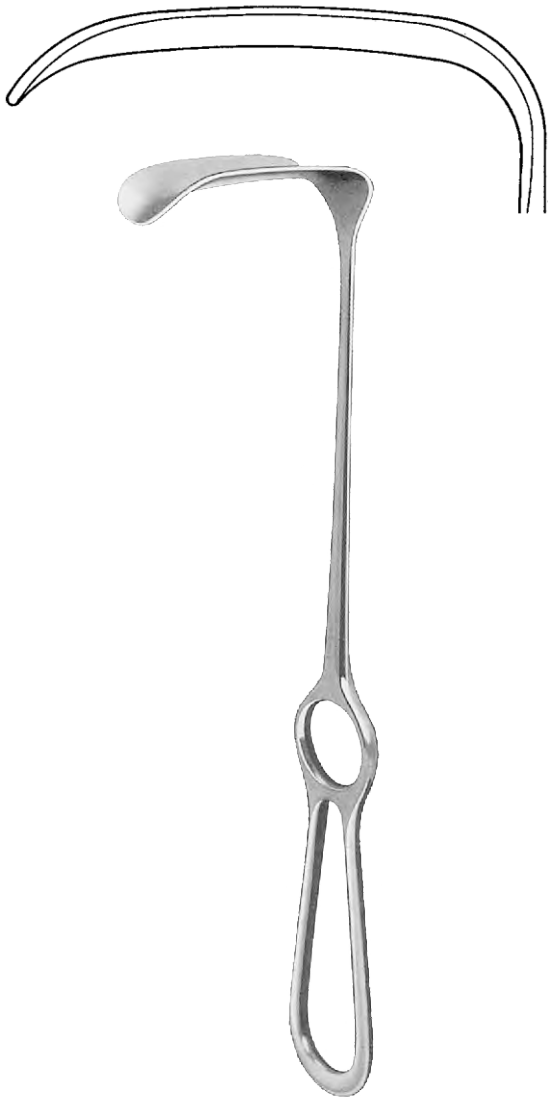

KOCHER
AN-07831
250mm (10")
Blade: 67mm x 25mm



CUSHINGS VEIN RETRACTORS
250mm (10")



AN-07832
Blade: 14mm x 11mm



AN-07833
Blade: 18mm x 13mm



AN-07834
Blade: 22mm x 15mm



HAND HELD RETRACTORS

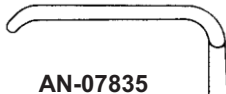

AN-07835
Blade: 25mm x 6mm

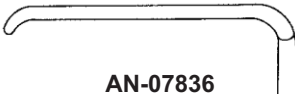

AN-07836
Blade: 35mm x 8mm



AN-07837
Blade: 35mm x 11mm

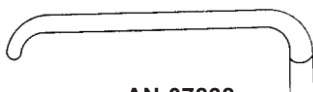

AN-07838
Blade: 35mm x 15mm

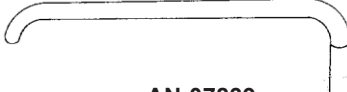

AN-07839
Blade: 41mm x 11mm

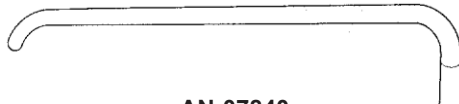

AN-07840
Blade: 55mm x 11mm



LANGENBECK
215mm (8 1/2")

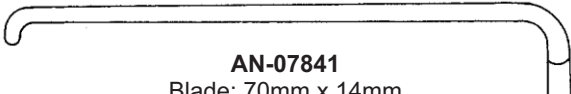

AN-07841
Blade: 70mm x 14mm

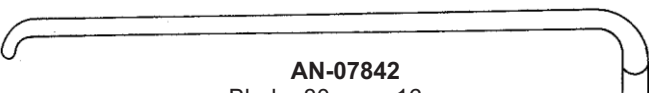

AN-07842
Blade: 80mm x 16mm

INSTRUMENTS

HAND HELD RETRACTORS



KOCHER
230mm (9")

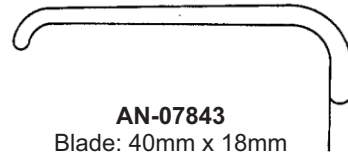

AN-07843
Blade: 40mm x 18mm

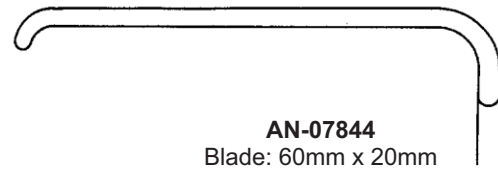

AN-07844
Blade: 60mm x 20mm

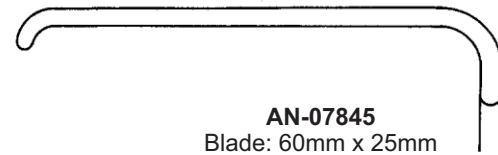

AN-07845
Blade: 60mm x 25mm

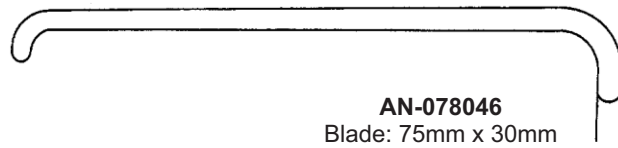

AN-078046
Blade: 75mm x 30mm



AN-07847
Blade: 75mm x 40mm



HAND HELD RETRACTORS



FARABEUF
125mm (5")

AN-07848
Set consisting of
Inner blade: 22mm x 10mm
28mm x 12mm
Outer blade: 25mm x 10mm
32mm x 12mm



FARABEUF
150mm (6")

AN-07849
Set consisting of
Inner blade: 20mm x 16mm
24mm x 16mm
Outer blade: 23mm x 16mm
28mm x 16mm



WALTON
305mm (12")
Malleable

AN-07850
13mm wide

AN-07851
25mm wide

AN-07852
38mm wide

AN-07853
51mm wide

HAND HELD RETRACTORS



AN-07854



AN-07855



AN-07858



AN-07859



165mm (6 1/2")
Small curve sharp



AN-07857



AN-07860



165mm (6 1/2")
Small curve blunt



AN-07861



AN-07862



AN-07863



AN-07866



AN-07867



165mm (6 1/2")
Large curve sharp



AN-07865



AN-07868



165mm (6 1/2")
Large curve blunt



AN-07869



HAND HELD RETRACTORS



AN-07870
Blade: 9mm x 8mm
Sharp



AN-07871
Blade: 8mm x 8mm
Blunt



AN-07872
Blade: 9mm x 19mm
Sharp



AN-07873
Blade: 8mm x 19mm
Blunt



VOLKMANN
220mm (8")



AN-07874
Blade: 9mm x 29mm
Sharp



AN-07875
Blade: 8mm x 29mm
Blunt



AN-07876
Blade: 9mm x 13mm
Sharp



AN-07877
Blade: 8mm x 13mm
Blunt

INSTRUMENTS

HAND HELD RETRACTORS



AN-07879



AN-07881



LEMPURT
225mm (9")

AN-07878
Blade 9mm x 19mm
Sharp

AN-07879
Blade 85mm x 19mm
Blunt



BALLANCE
225mm (9")

AN-07880
Blade 9mm x 29mm
Sharp

AN-07881
Blade 85mm x 29mm
Blunt

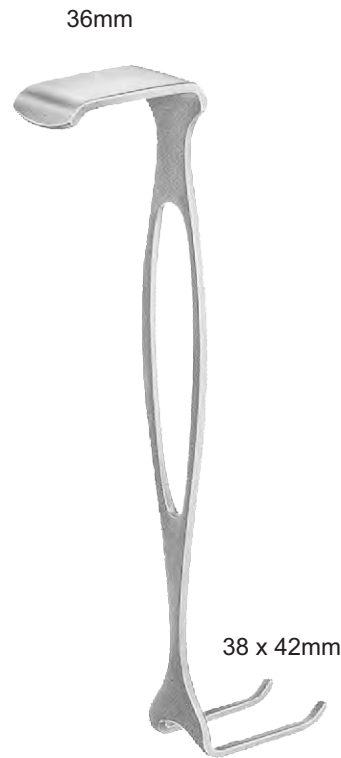

CZERNY

AN-07883
175mm (7")



HAND HELD RETRACTORS



ISRAEL
255mm (10")

AN-07883
Blade: 39mm x 40mm
Blunt



AN-07884
Blade: 47mm x 51mm
Blunt

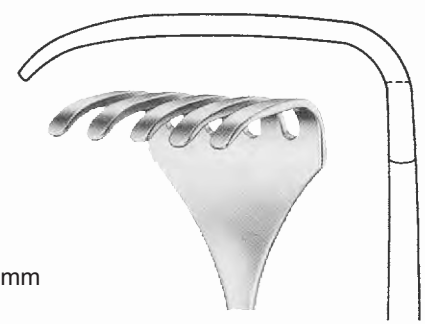

AN-07885
Blade: 53mm x 62mm
Blunt

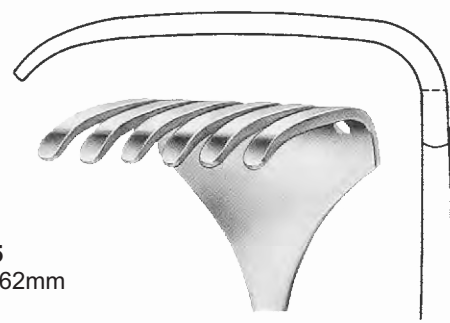

AN-07886
Blade: 70mm x 70mm
Blunt

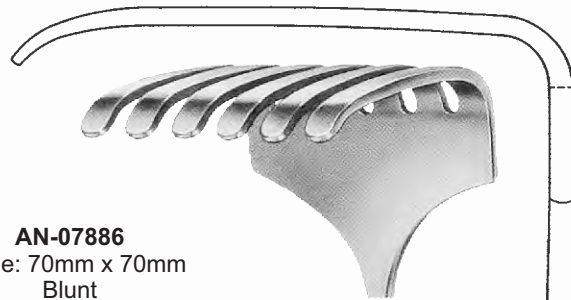

HAND HELD RETRACTORS

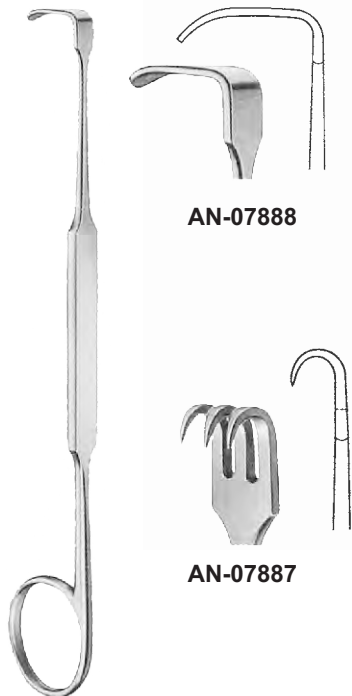

AN-07888

AN-07887

MEYERDING
180mm (7")

AN-07887
Blade: 5mm x 10mm
Sharp

AN-07888
Blade: 7mm x 18mm



LAGENBECK-GREEN

AN-07889
160mm (6 1/4")
Blade: 16mm x 6mm



CANNY RYAL

AN-07890
190mm (7 1/2")
Blade: 16mm

AN-07891
190mm (7 1/2")
Blade: 20mm

AN-07892
200mm (8")
Blade: 25mm



HAND HELD RETRACTORS

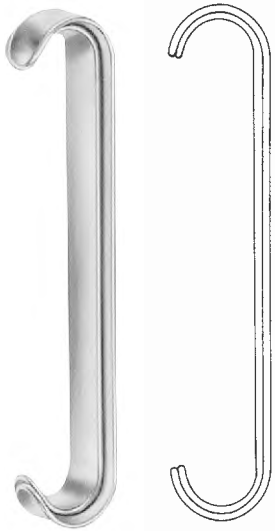

PARKER

AN-07893

135mm (5 3/4")

Inner blade: 18mm x 15mm

Outer blade: 22mm x 15mm

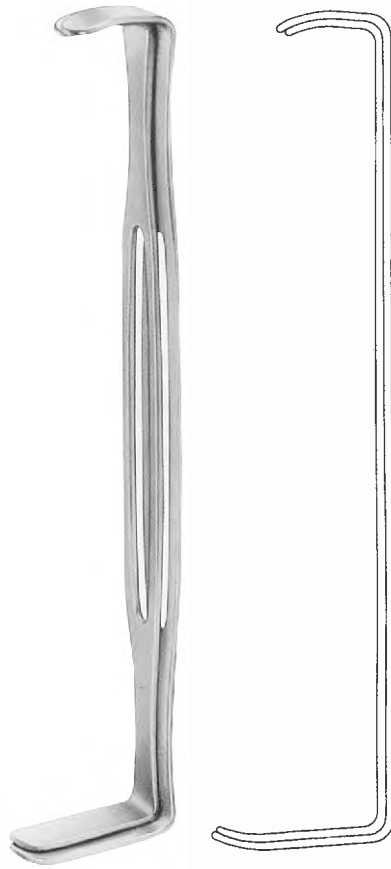

US ARMY

AN-07894

220mm (8 3/4")

Inner blade: 22mm x 15mm

39mm x 15mm

Outer blade: 26mm x 15mm

43mm x 15mm



ROUX

165mm (6 1/2")

AN-07895

Set of three consisting of:

AN-07896

Blades: 19mm x 22mm

23mm x 30mm

AN-07897

Blades: 25mm x 26mm

28mm x 38mm

AN-07898

Blades: 28mm x 29mm

33mm x 45mm

HAND HELD RETRACTORS

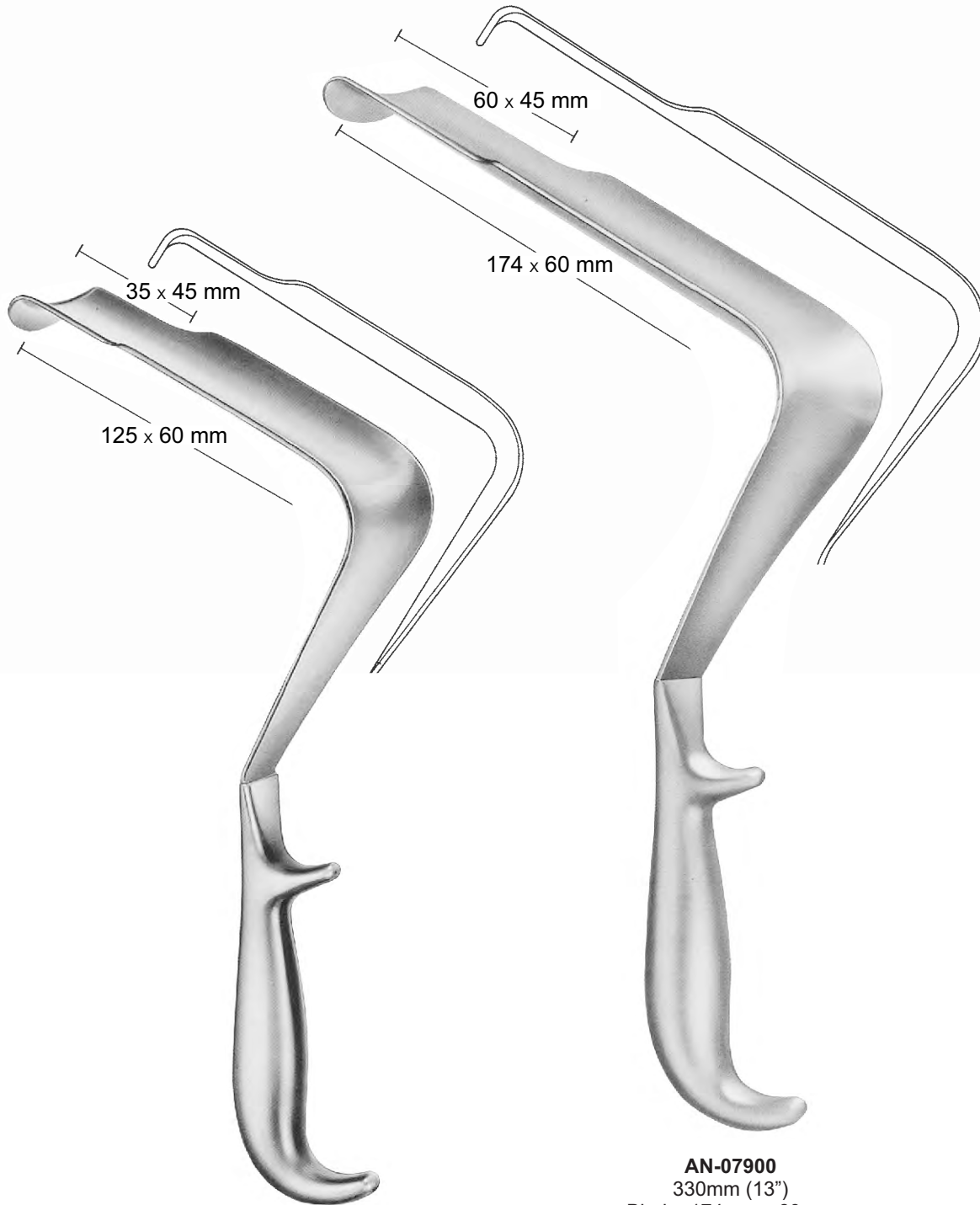

LLOYD DAVIS

AN-07899
290mm (11 1/2")
Blade: 125mm x 60mm
End: 35mm x 45mm

AN-07900
330mm (13")
Blade: 174mm x 60mm
End: 60mm x 45mm



HAND HELD RETRACTORS



SIMON

AN-07901
220mm (8 3/4")



DOYEN

AN-07902
250mm (10")
Blade: 53mm x 80mm



RETRACTOR

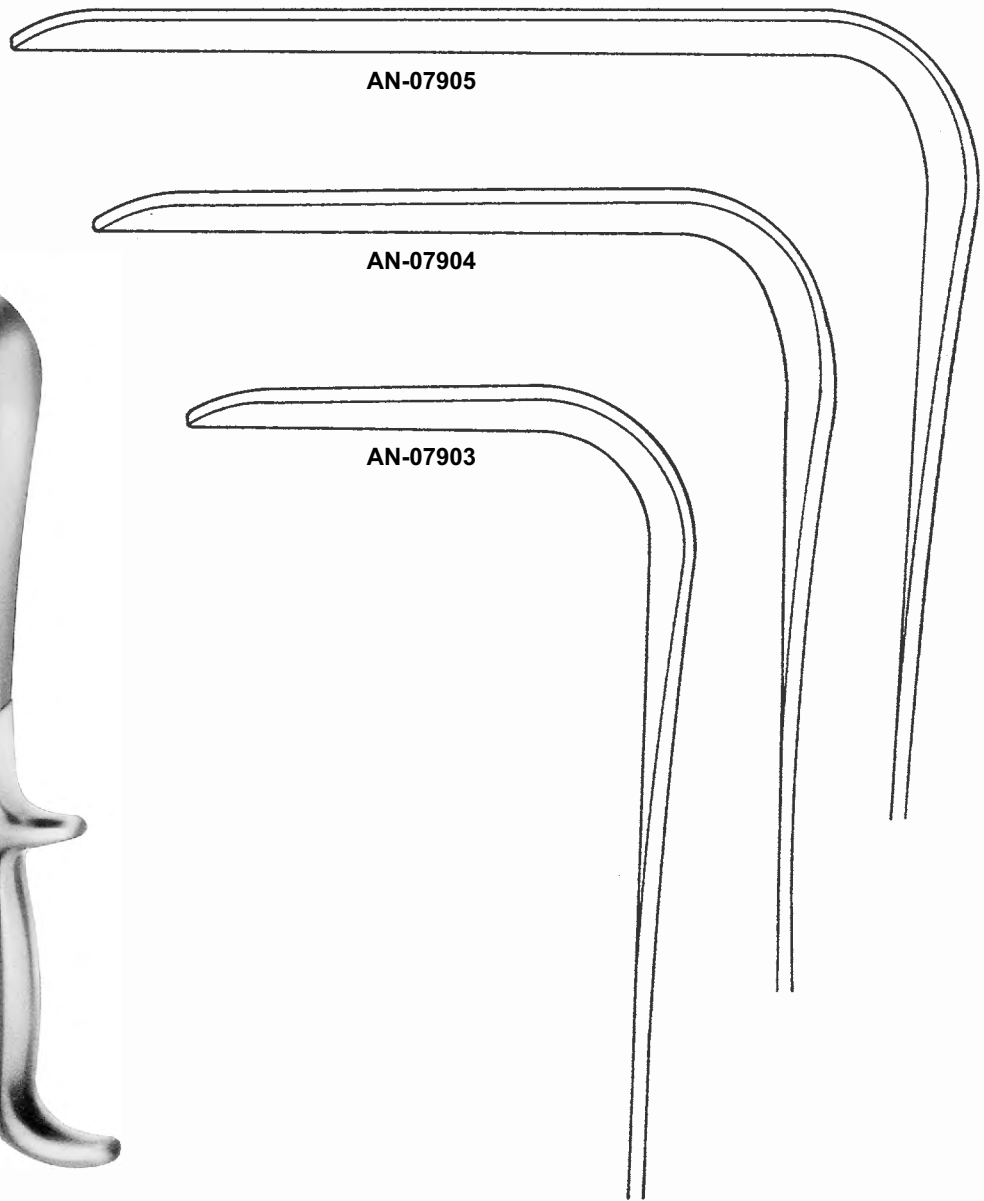

DOYEN
240mm (9 1/2")

AN-07903
Blade: 60mm x 45mm

AN-07904
Blade: 90mm x 45mm

AN-07905
Blade: 120mm x 45mm





HAND HELD RETRACTORS



ABDOMINAL RETRACTOR
240mm (9 1/2")

AN-07906
Blade: 34mm x 50mm

AN-07907
Blade: 46mm x 75mm

AN-07908
Blade: 64mm x 85mm

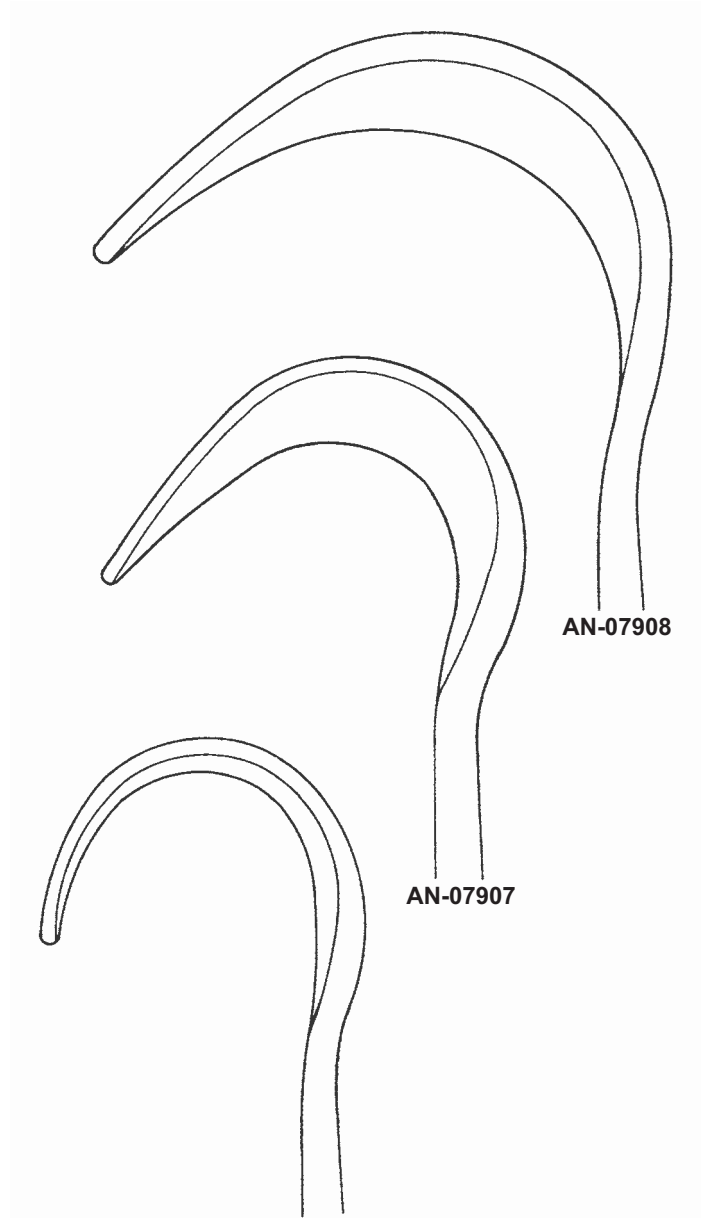

AN-07906

AN-07907

AN-07908

HAND HELD RETRACTORS



WERTHEIM

AN-07909
300mm (12")
Blade: 100mm x 40mm

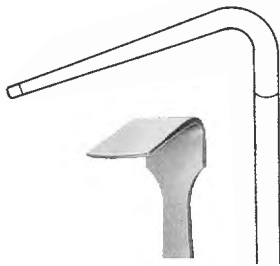

AN-07912
Blade: 32mm x 19mm

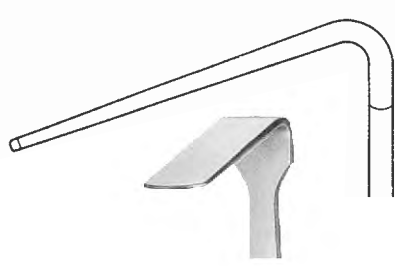

AN-07913
Blade: 41mm x 19mm



AN-07914
Blade: 57mm x 19mm



SMILLIE RETRACTORS

AN-07910
145mm (5 3/4")

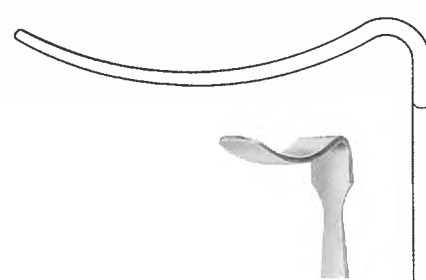

AN-07915
Blade: 10mm



AN-07911



HAND HELD RETRACTORS

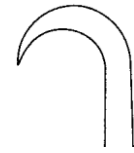

**LANGENBECK
BONE HOOK**

AN-07916
205mm (8")
Sharp

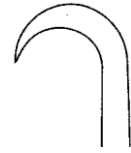

**LANGENBECK
BONE HOOK**

AN-07917
205mm (8")
Blunt

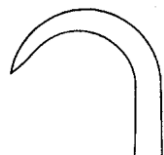

**KOCHER
BONE HOOK**

AN-07918
220mm (8 3/4")
Sharp

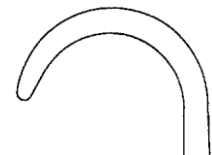

**KOCHER
BONE HOOK**

AN-07919
220mm (8 3/4")
Blunt



RETRACTOR



RETRACTOR
155mm (6")
Flexible shaft



AN-07920
2 prong, sharp



AN-07921
2 prong, blunt



AN-07922
3 prong, sharp



AN-07923
3 prong, blunt



AN-07925
4 prong, sharp



AN-07924
4 prong, blunt



RETRACTOR



AN-07926
125mm (5")



AN-07927
135mm (5 1/4")



AN-07928
130mm (5 1/8")



KILNER
150mm (6")

AN-07929
Sharp

AN-07930
Blunt





HAND HELD RETRACTORS



SENN-MILLAR
AN-07931
165mm (6 1/2")

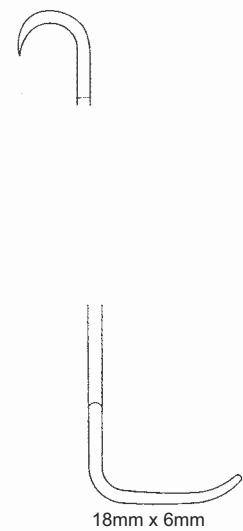

KILNER
AN-07937
150mm (6")



AN-07933
Blade: 9mm x 12mm



AN-07934
Blade: 13mm x 16mm



AN-07932
DESMARRES
140mm (5 1/2")



AN-07935
Blade: 13mm x 18mm



AN-07936
Blade: 11mm x 14mm



RETRACTOR



KILNER
150mm (6")

AN-07938
Blades: 25mm x 19mm
Small

AN-07939
Blades: 35mm x 29mm
Large



HAJEK
AN-07940
165mm (6 1/2")



GILLIES SKIN HOOK
180mm (7")



AN-07941
Standard



AN-07942
Small



MCINDOE SKIN HOOK
AN-07943
191mm (7 1/2")



BARSKY SKIN HOOK
AN-07944
152mm (6")
Double, adjustable





HAND HELD RETRACTORS



MCINDOE SKIN HOOK
152mm (6")
Double



AN-07945
9mm wide



AN-07946
10mm wide



AN-07947
11mm wide



EAST GRINSTEAD SKIN HOOK
AN-07948
150mm (6")

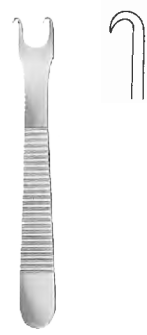

KILNER ALAE
80mm (3 1/4")
sharp

AN-07949
10mm wide

AN-07950
13mm wide



BOWDLER-HENRY RAKE

AN-07951
190mm (7 1/2")

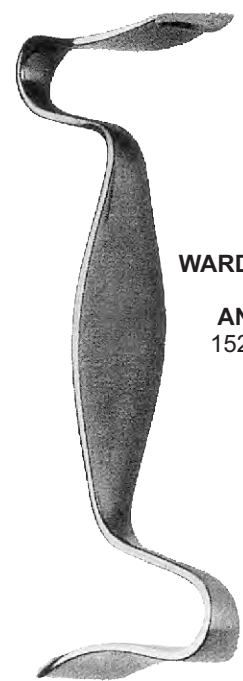

WARDS CHEEK

AN-07952
152mm (6")

HAND HELD RETRACTORS



CAIRNS "RAKE"
220mm (8 3/4")



AN-07953
Blade 16mm x 14mm
Sharp



AN-07954
Blade 14mm x 18mm
Sharp

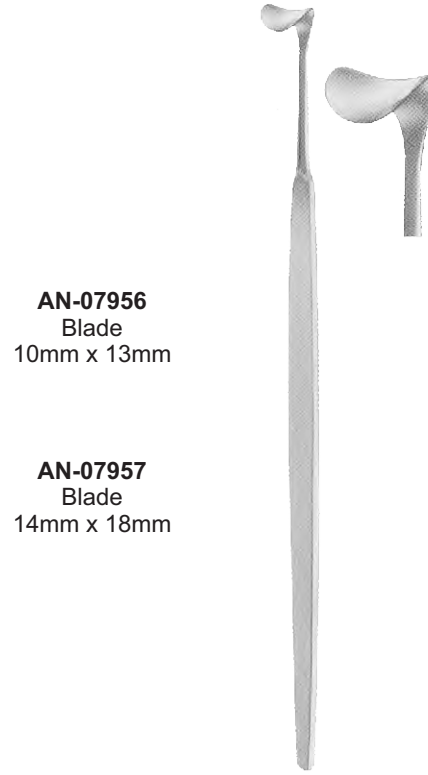

**CAIRNS
(CUSHING)**
205 mm (8")

AN-07956
Blade
10mm x 13mm

AN-07957
Blade
14mm x 18mm



CAIRNS STRIP
200mm (8")
Malleable

AN-07958
6mm wide

AN-07959
8mm wide

AN-07960
10mm wide

AN-07961
11mm wide

AN-07962
13mm wide

AN-07963
16mm wide

AN-07964
19mm wide

AN-07965
25mm wide



ADSON
AN-07966
190mm (7 1/2")
sharp



HAND HELD RETRACTORS



CUSHING BRAIN SPOON
180mm (7")
Flexible

AN-07967
Set of four consisting of:
1 x L33-07968
1 x L33-07969
1 x L33-07970
1 x L33-07971

AN-07969
Ends: 11mm and 13mm

AN-07970
Ends: 15mm and 18mm

AN-07971
Ends: 18mm and 22mm

AN-07968
Ends: 7mm and 9mm



CRILE
AN-07972
200mm (8")



CUSHING
AN-07973
190mm (7 1/2")

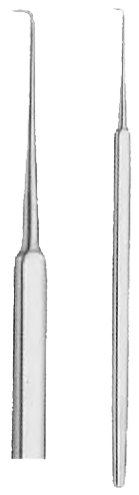

CAIRNS
AN-07974
125mm (5")
Sharp

INSTRUMENTS

HAND HELD RETRACTORS



ST-BRATS MODEL

AN-07975
140mm (5 1/2")
Blunt

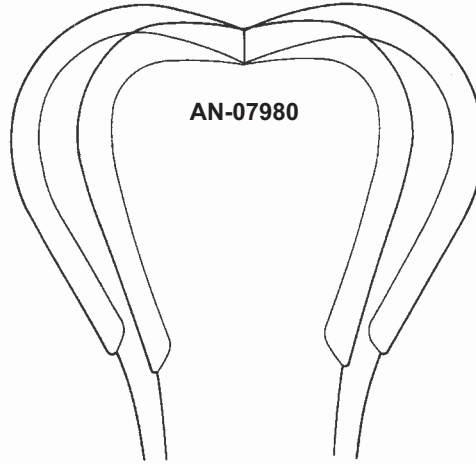

AN-07980

AN-07981



HARRINGTON
295mm (11 3/4")
Flexible

AN-07980
Blade: 123mm x 45mm

AN-07981
Blade: 123mm x 64mm



AN-07976
Single Hook,
Blunt

AN-07978
Single Hook,
Sharp



AN-07977
Double Hook,
Blunt

AN-07979
Double Hook
Sharp

TRACHEAL HOOK
180mm (7")



HAND HELD RETRACTORS

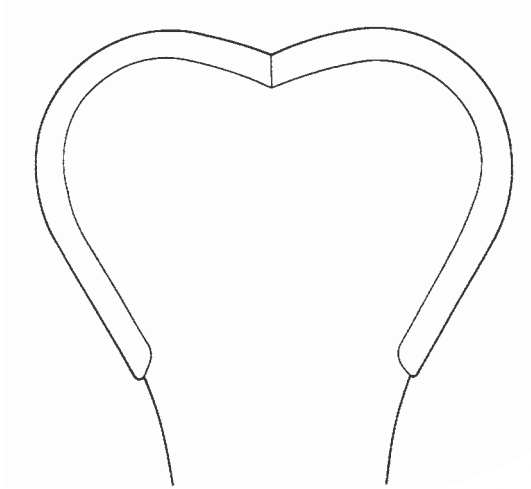

HARRINGTON - PEMBERTON
Flexible

AN-07982
295mm (11 3/4")
Blade: 175mm x 64mm



ALLISON
AN-07983
255mm (10")
Blade: 40mm wide

HAND HELD RETRACTORS



ALLISON
AN-07984
320mm (12 3/4")
Blade: 54mm wide

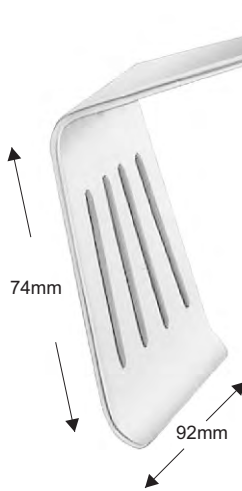
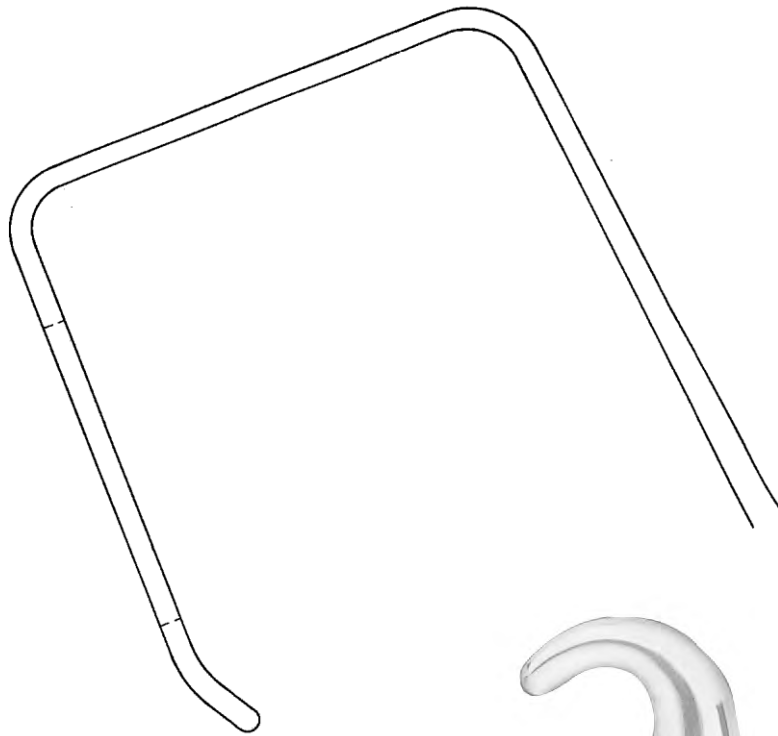

DAVIDSON
AN-07985
195mm (7 3/4")
Scapula retractor



SELF RETAINING RETRACTORS

TURNER WARWICK ABDOMINAL RETRACTOR SET

Set consists of:

- 1 x AN-07986
- 1 x AN-07987
- 1 x AN-07988
- 1 x AN-07989
- 2 x AN-07990
- 2 x AN-07991
- 2 x AN-07992
- 2 x AN-07993
- 2 x AN-07994
- 2 x AN-07995
- 2 x AN-07996
- 2 x AN-07997
- 2 x AN-07998

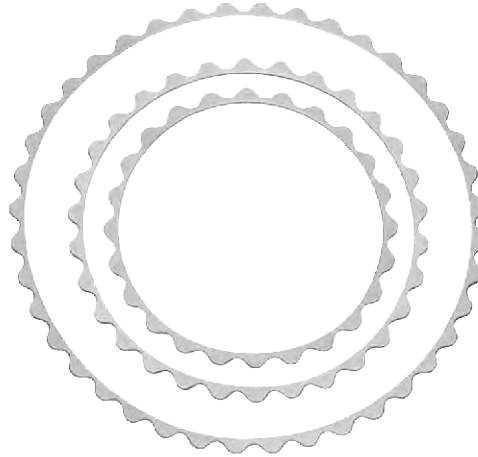

TURNER WARWICK RETRACTOR FRAMES

Circular

AN-07986
178mm (7") diameter

AN-07987
229mm (9") diameter

AN-07988
305mm (12") diameter

AN-07989
457mm x 330mm
(18" x 13")

TURNER WARWICK RETRACTOR BLADES



AN-07990
Blade: 19mm x 76 mm
Flat, copper blade,
blackened shaft

AN-07991
Blade: 38mm x 102mm
Flat, copper blade,
blackened shaft with
sliding retainer clip

AN-07992
Blade: 57mm x 89mm
Flat, copper blade,
blackened shaft with
sliding retainer clip

AN-07993
Blade: 57mm x 114mm
Flat, copper blade,
blackened shaft with
sliding retainer clip

SELF RETAINING RETRACTORS



TURNER WARWICK RETRACTOR BLADES



AN-07994
Blade: 51mm x 38mm
Curved, blackened finish

AN-07995
Blade: 76mm x 60mm
Curved, blackened finish



AN-07996
Blade: 89mm x 60mm
Flat, polished front surface

AN-07997
Blade: 114mm x 60mm
Flat polished front surface



AN-07998
13mm deep
Single hook blade

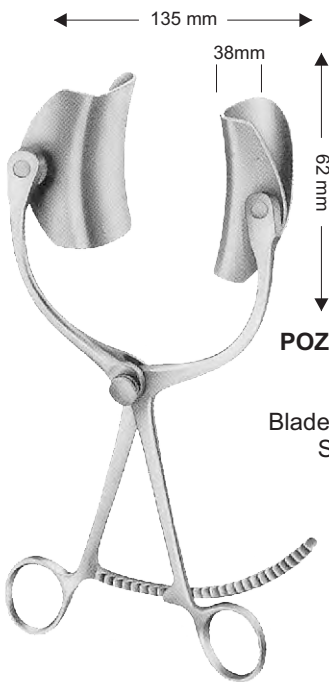

POZZI ABDOMINAL

AN-07999
Blades: 62mm x 38mm
Swivel blades



POZZI ABDOMINAL

AN-08000
Lateral blades:
62mm x 38mm

Center blade:
55mm x 55mm



RETRACTOR



RICARD

AN-08001

Lateral blades: 58mm x 80mm
Centre blade: 54mm x 70mm

AN-08002

Lateral blades: 72mm x 84mm
Centre blade: 72mm x 90mm

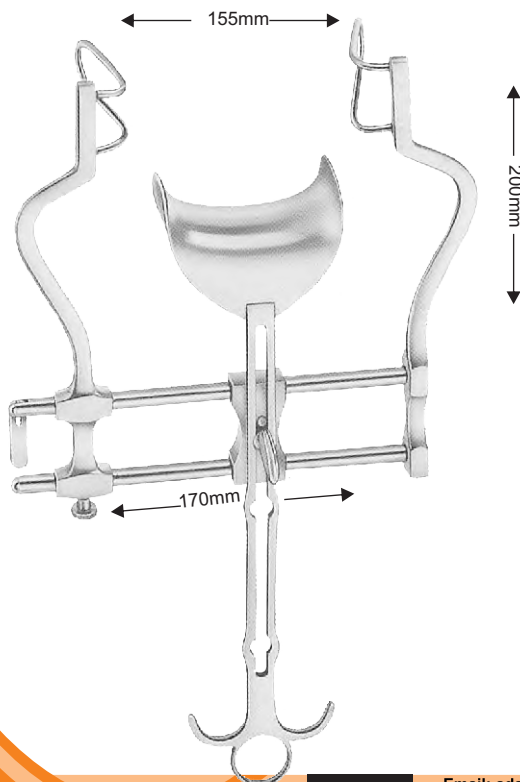

BALFOUR ABDOMINAL

AN-08003

Lateral blades: 60mm
Centre blade: 47mm x 80mm

AN-08004

Lateral blades: 60mm
Centre blade: 62mm x 76mm

AN-08005

Lateral blades: 90mm
Centre blade: 80mm x 80mm

AN-08006

Lateral blades: 105mm
Centre blade: 59mm x 107mm

RETRACTOR



KIRSCHNER RETRACTOR SET

AN-08007
Set comprising of:
1 x L40-08008
2 x L40-08009
2 x L40-08010

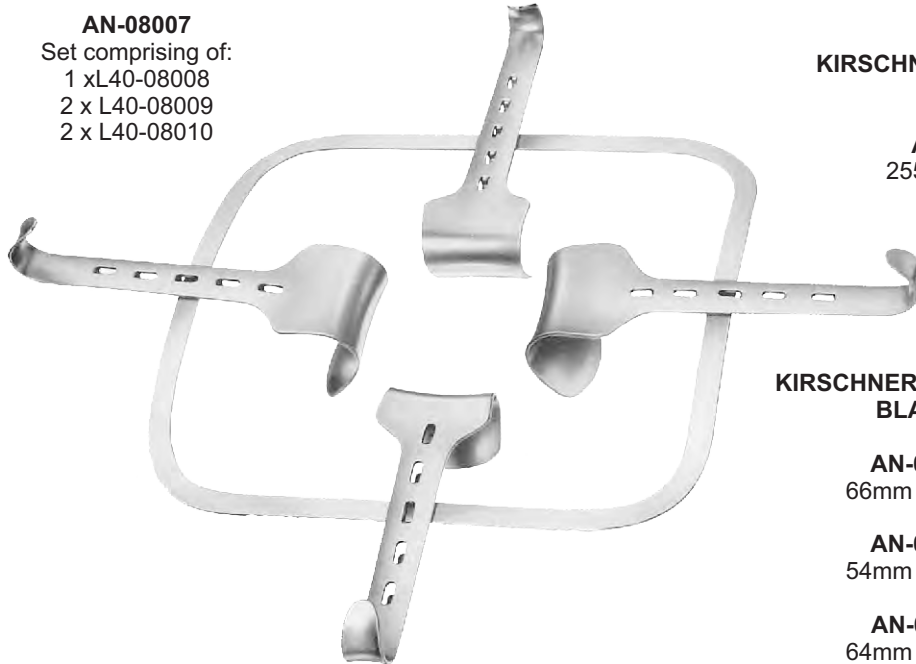

KIRSCHNER RETRACTOR FRAME

AN-08008
255mm square

KIRSCHNER RETRACTOR BLADES

AN-08009
66mm x 48mm

AN-08010
54mm x 42mm

AN-08011
64mm x 80mm

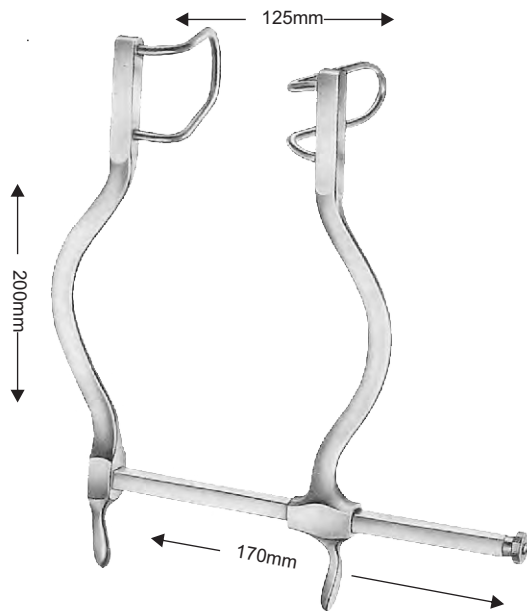

GOSSET

AN-08012
Blades: 55mm

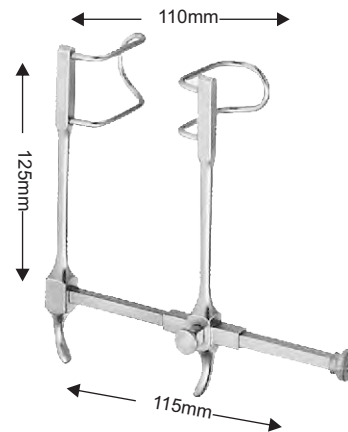

GOSSET

AN-08013
Blades: 38mm



SELF RETAINING RETRACTORS

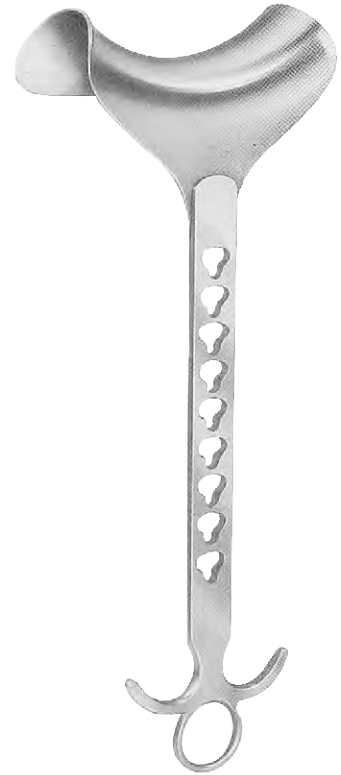

STERNAL / ABDOMINAL RETRACTOR BLADES

AN-08015
48mm x 90mm

AN-08016
48mm x 105mm

AN-08017
48mm x 120mm

AN-08018
48mm x 135mm

AN-08019
48mm x 155mm

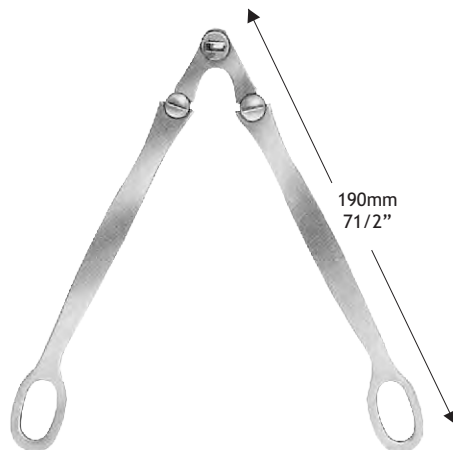

STERNAL / ABDOMINAL RETRACTOR FIXATION DEVICE

AN-08020
Fixation device for blades

SELF RETAINING RETRACTORS

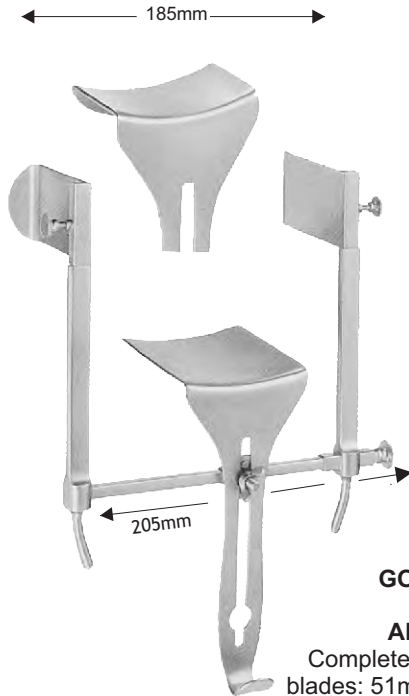

GOLIGHER

AN-08021
 Complete with two centre blades: 51mm deep, and four lateral blades:
 2 x 51mm deep
 2 x 102mm deep

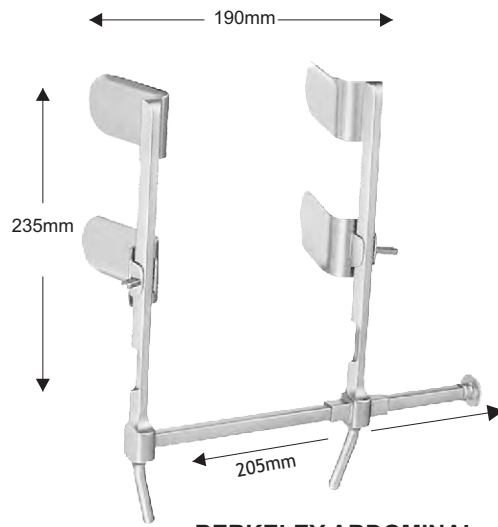

BERKELEY ABDOMINAL

AN-08022
 Blades: 35mm x 60mm



TRAVERS

AN-08023
 200mm (8")
 4 x 5 teeth
 Blunt



IRWIN

AN-08024
 178mm (7")
 4 x 5 teeth
 Sharp



SELF RETAINING RETRACTORS



WEISLANDER

AN-08025
110mm (43/8")
2 x 3teeth, sharp



WEISLANDER

AN-08026
110mm (43/8")
2 x 3 teeth blunt



RNTNE HOSPITAL

AN-08027
159mm (61/4")
3 x 4 teeth



NORFOLK AND NORWICH

AN-08028
215mm (81/2")
4 x 5 teeth, blunt

SELF RETAINING RETRACTORS



WEISLANDER
3 x 4 teeth, blunt

AN-08029
130mm (5 1/8")

AN-08030
156mm (6 1/2")



WEISLANDER
3 x 4 teeth, sharp

AN-08031
130mm (5 1/8")

AN-08032
165mm (6 1/2")



WEISLANDER
3 x 4 teeth, semi sharp

AN-08033
130mm (5 1/8")

AN-08034
165mm (6 1/2")



SELF RETAINING RETRACTORS



WEISLANDER

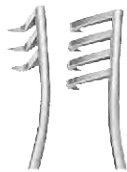

AN-08035
195mm (73/4")
3 x 4 teeth
sharp



AN-08036
240mm (91/2")
3 x 4 teeth
sharp



AN-08037
255mm (10")
5 x 6 teeth
sharp



AN-08038
195mm (73/4")
3 x 4 teeth
blunt



AN-08039
240mm (91/2")
3 x 4 teeth
blunt

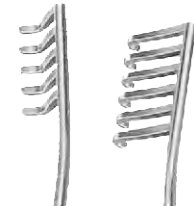

AN-08040
255mm (10")
5 x 6 teeth
blunt

SELF RETAINING RETRACTORS



JOLL THYROID

AN-08041
152mm (6")

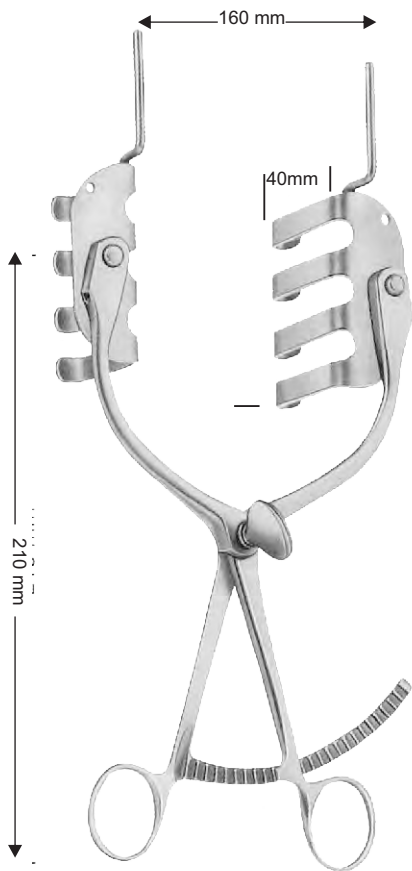

ST MARKS HOSPITAL PERINEAL
210mm (83/8")

AN-08042
Blades: 70mm x 40mm



MILLIN RETROPUBIC

AN-08043
Blades
55mm x 25mm
80mm x 25mm

Centre blade:
115mm x 45mm



SELF RETAINING RETRACTORS

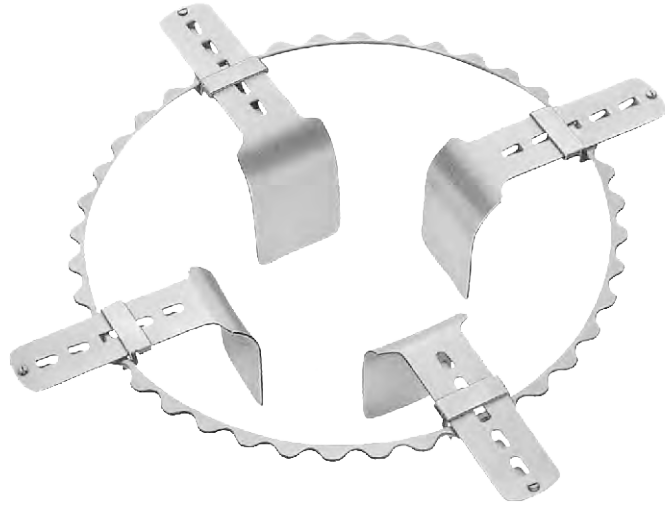

TURNER WARWICK

AN-08044
140mm x 180mm (7" x 5 1/2")
Oval sprocket frame and four blades



GELPI VULVA

AN-08045
165mm (6 1/2")



GELPI VULVA

AN-08046
135mm (5 1/4")



JACKSON - BURROWS

AN-08047
165mm (6 1/2")



FINSON

AN-08048
70mm (2 3/4")

SELF RETAINING RETRACTORS



AN-08049
100mm (4")



ALMS

AN-08050
70mm (23/4")
sharp / blunt

AN-08051
100mm (4")
sharp blunt



LOGAN

AN-08052
50mm (2")



KILNER SKIN

AN-08053
50mm (2")
Small teeth

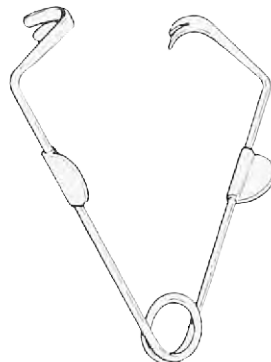

KILNER SKIN

AN-08054
50mm (2")
Long teeth



CAIRNS SCALP

AN-08055
140mm (5 1/2")
Curved, swivel blades, sharp



SELF RETAINING RETRACTORS

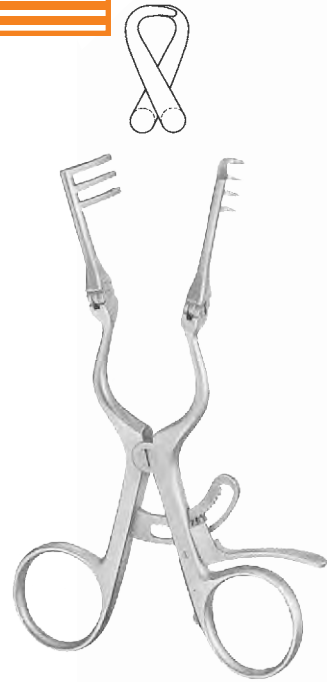

CONE
AN-08056
 145mm (53/4")



JANSON (SHEA)
AN-08057
 105mm (41/8")

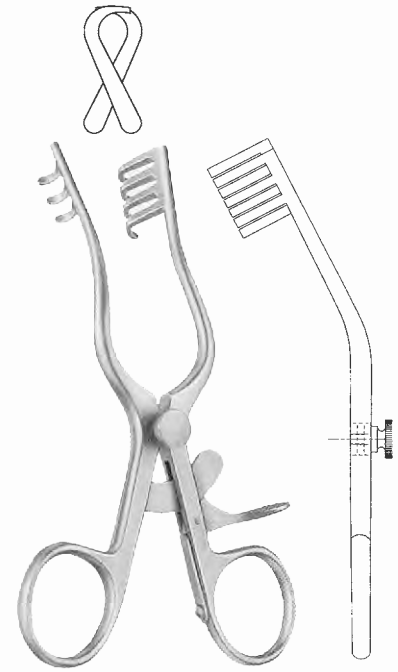

JEFFERSON
AN-08058
 140mm (51/2")



HENDERSON
AN-08059
 130mm (51/8")



TRAVERS
AN-08060
 195mm (73/4")
 Sharp

SELF RETAINING RETRACTORS

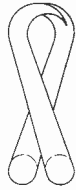

CONE LAMINECTOMY

AN-08061
254mm (10"), Hinged arms

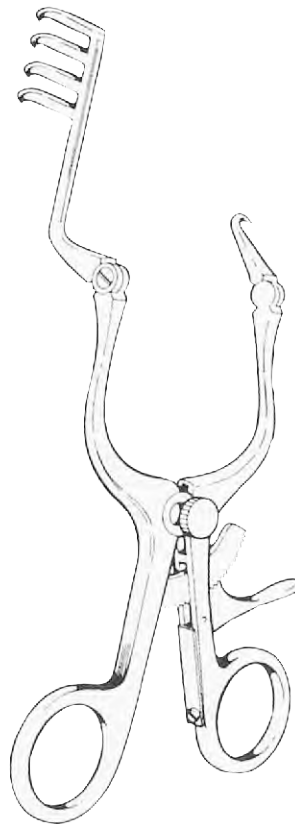

CONE HEMI-LAMINECTOMY
Left hinged arm

AN-08062
165mm (6 1/2")

AN-08063
254mm (10")

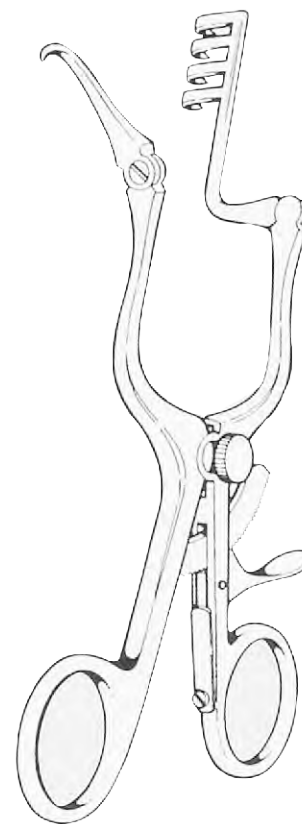

CONE HEMI-LAMINECTOMY
Right hinged arm

AN-08064
165mm (6 1/2")

AN-08065
254mm (10")



SELF RETAINING RETRACTORS

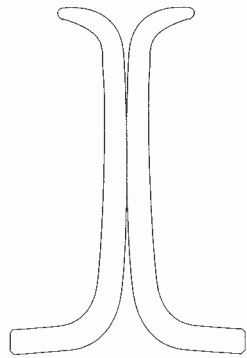

HARVEY-JACKSON LAMINECTOMY

AN-08066
280mm (11 1/2")
Blades: 38mm x 44mm

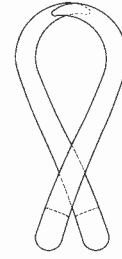

MAYO-ADSON (BECKMANN) LAMINECTOMY

AN-08067
280mm (11 1/2")
Blades: 38mm x 44mm

SELF RETAINING RETRACTORS

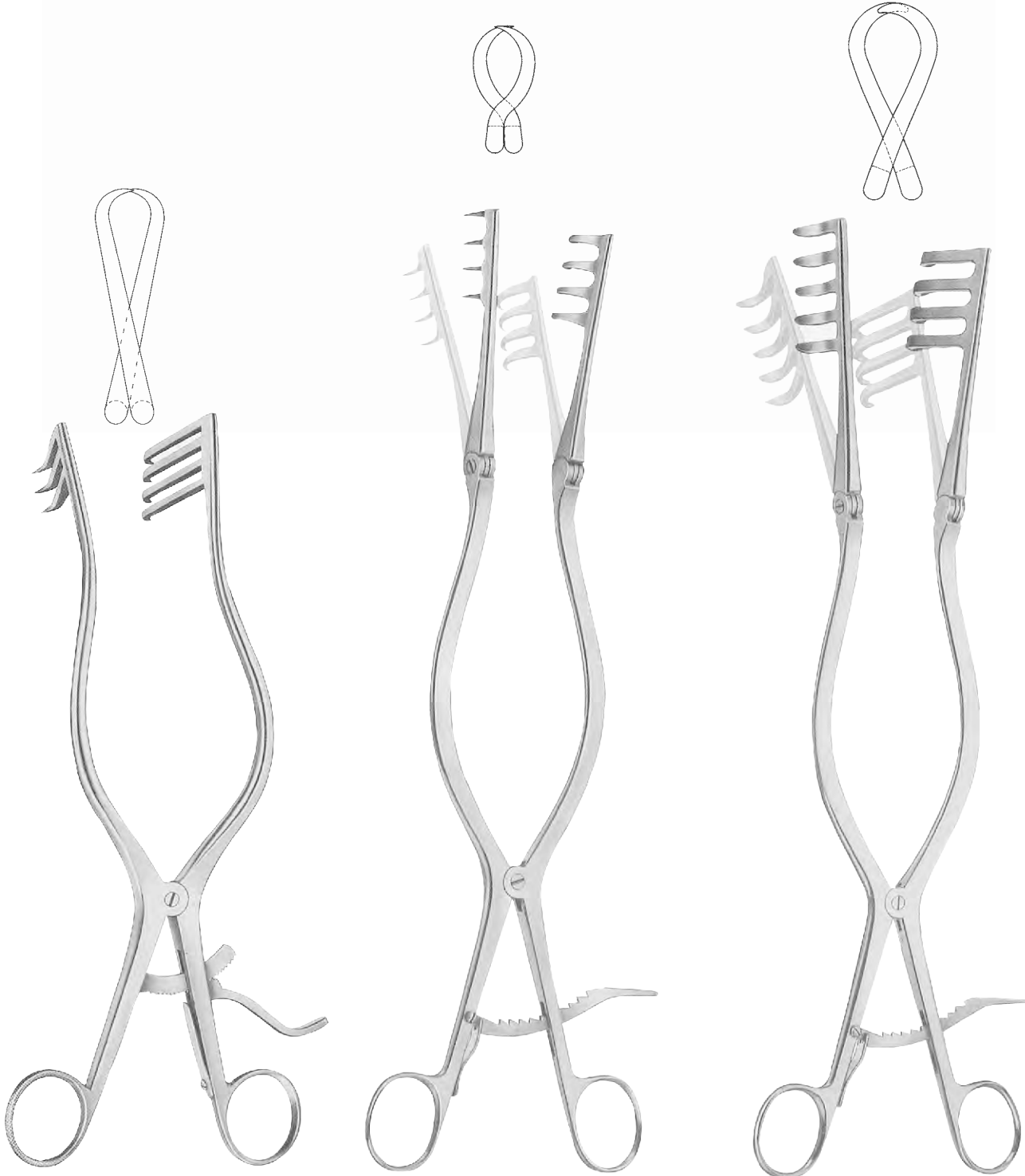

ADSON

AN-08068
265mm (10 1/2")

BECKMANN-ADSON

AN-08069
310mm (12")

ADSON

AN-08070
320mm (12 3/4")
Semi - sharp



SELF RETAINING RETRACTORS

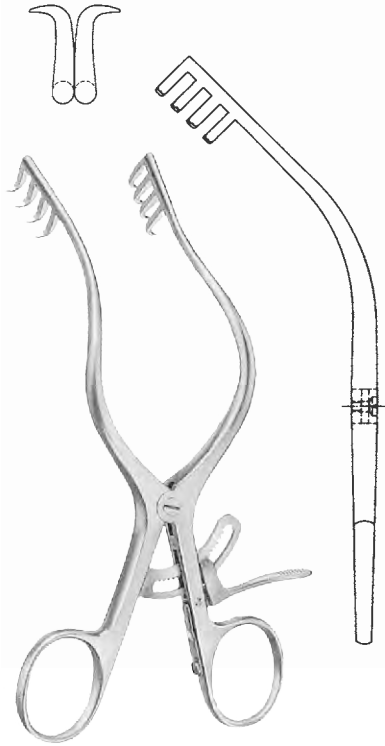

MOLLISON

AN-08071
165mm (6 1/2")



MOLLISON

AN-08072
133mm (5 1/4")



PLESTER-JANSEN

AN-08073
140mm (5 1/2")



**PLESTER-JANSEN
Right**

AN-08074
140mm (5 1/2")

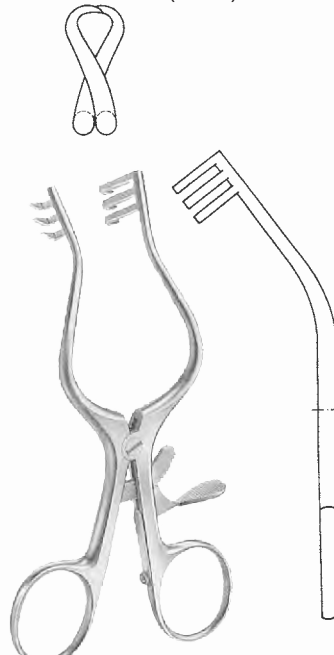

PLESTER-JANSEN

AN-08075
140mm (5 1/2")

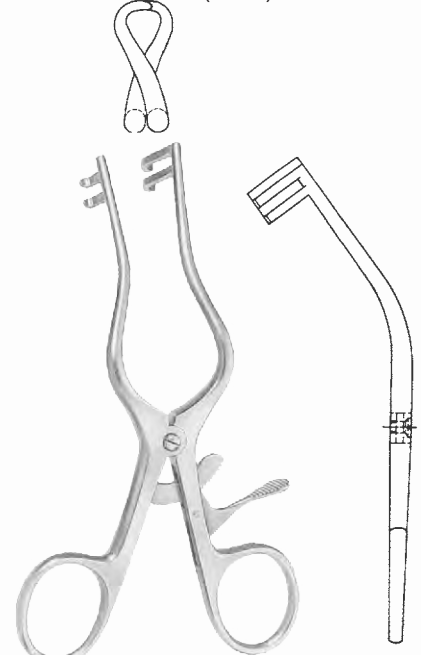

**WALLACE MODIFIED
PLESTER-JANSEN**

AN-08076
140mm (5 1/2")

SELF RETAINING RETRACTORS

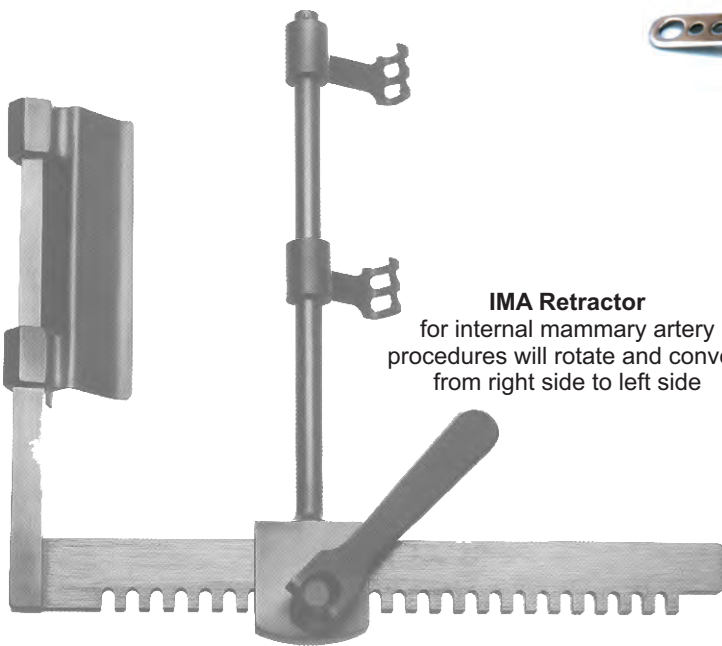

IMA Retractor
for internal mammary artery
procedures will rotate and convert
from right side to left side

IMA RETRACTOR

AN-08077



**CHARNLEY INITIAL INCISION
RETRACTOR**
with weight and chain

AN-08078

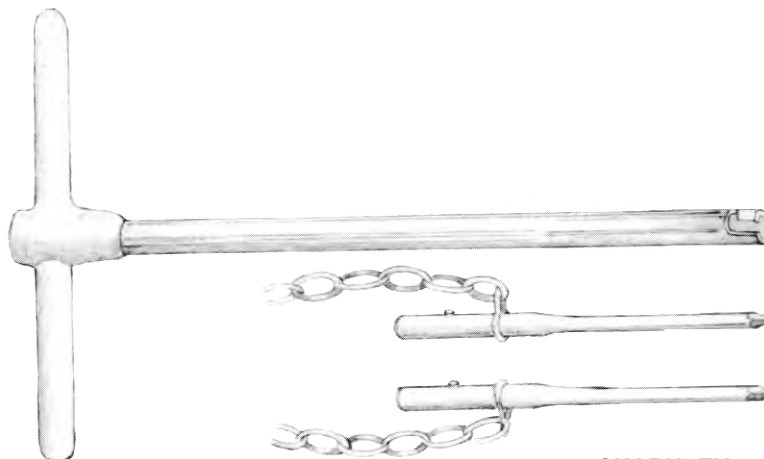

**CHARNLEY
PIN RETRACTOR**

AN-08079



TROCARS



NESTED TROCARS

AP-09000
171mm (63/4")
19mm, 33mm, 45mm and 60mm
Set of four

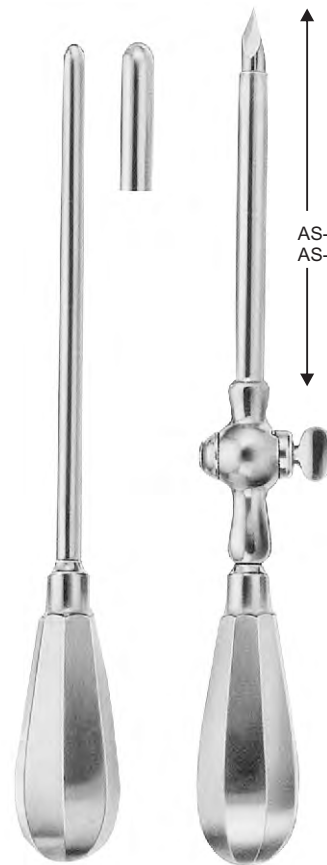

AS-09005 100mm
AS-09006 110mm

SUPRAPUBIC

AP-09005
ID 90mm OD 100mm

AP-09006
ID 70mm OD 80mm

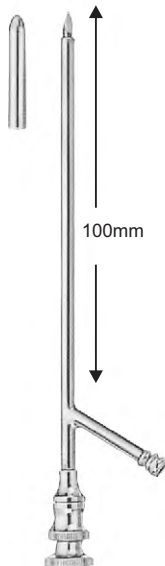

OSCHNER GALL BLADDER

AP-09001
ID 36mm OD 46mm

AP-09002
ID 50mm OD 60mm

AP-09003
ID 30mm OD 40mm

AP-09004
ID 43mm OD 53mm

TROCARS

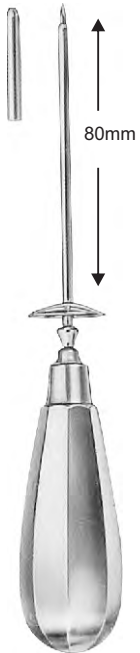

NELSON EMPYEMA
191mm (7 1/2")

AP-09011
22fg (733mm)

AP-09012
27fg (9mm)

AP-09013
33fg (11mm)

TILLEY LICHTWITZ
ANTRAL

Cannula: 102mm (4")
Trocar: 197mm (7 3/4")

AP-09007
5fg (166mm)

AP-09008
6fg (2mm)

AP-09009
7fg (233mm)

AP-09010
8fg (266mm)

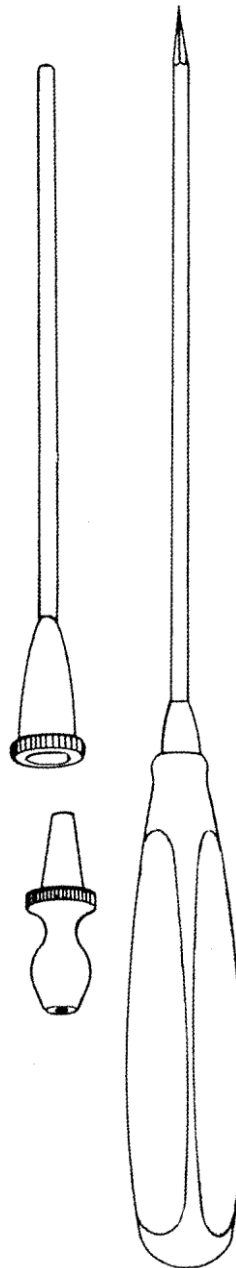



CHOLECYSTECTOMY & GALL STONE

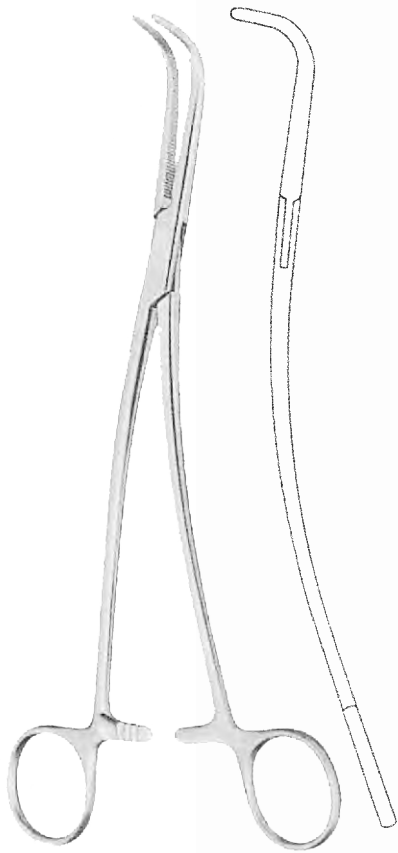

GEARY GRANT

AO-09200
230mm (9")
Large curved



LAHEY

AO-09201
195mm (7 3/4")

AO-09202
230mm (9")



LOWER

AO-09203
180mm (7")

CHOLECYSTECTOMY & GALL STONE

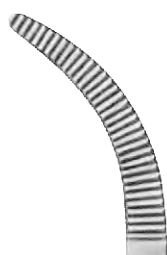

MIXSTER
AO-09204
220mm (83/4")
AO-09205
250mm (10")



MOYNIHAN
AO-09206
230mm (9")

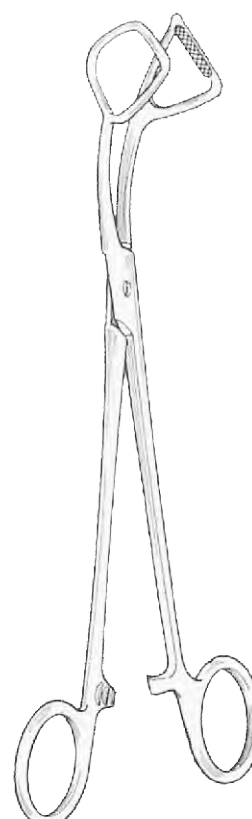

**MOUAT GALL BLADDER
LIFTING FORCEPS**
AO-09207
215mm (81/2")



CHOLECYSTECTOMY & GALL STONE

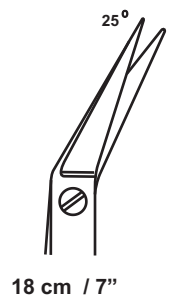
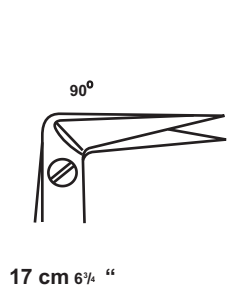

**POTTS-DE
MARTEL**
AO-09208
220mm (8 3/4")

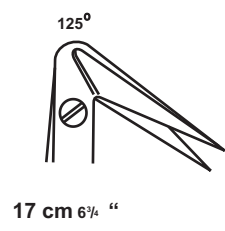

MILLS
AO-09209
230mm (8 3/4")

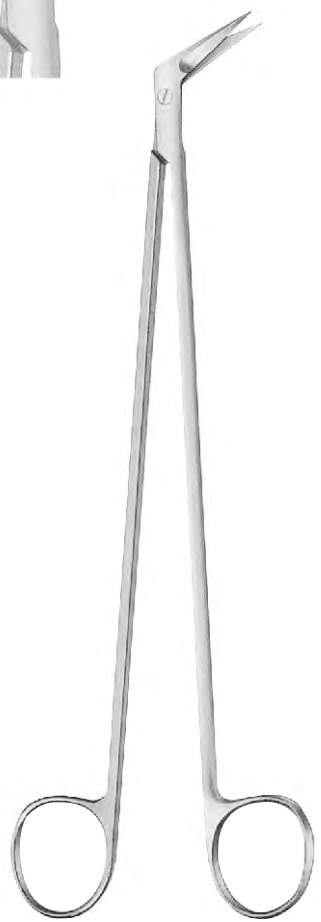

GALL DUCT SCISSORS

GALL DUCT PROBES



MOYNIHAN

AO-09210

345mm (133/4")

Gall stone probe and scoop
malleable

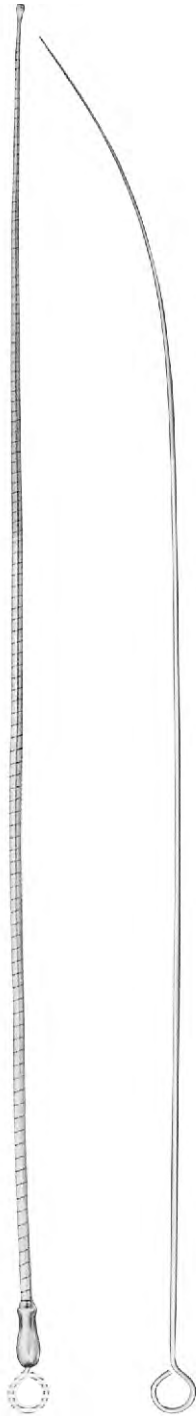

OCHSNER

AO-09211

400mm (16")

Gall duct probe flexible



38mm diameter

AO-09212

43mm diameter

AO-09213

68mm diameter

AO-09214

DESJARDINS

285mm (111/4")

Gall duct probes, flexible



GALL DUCT DILATORS / SCOOPS

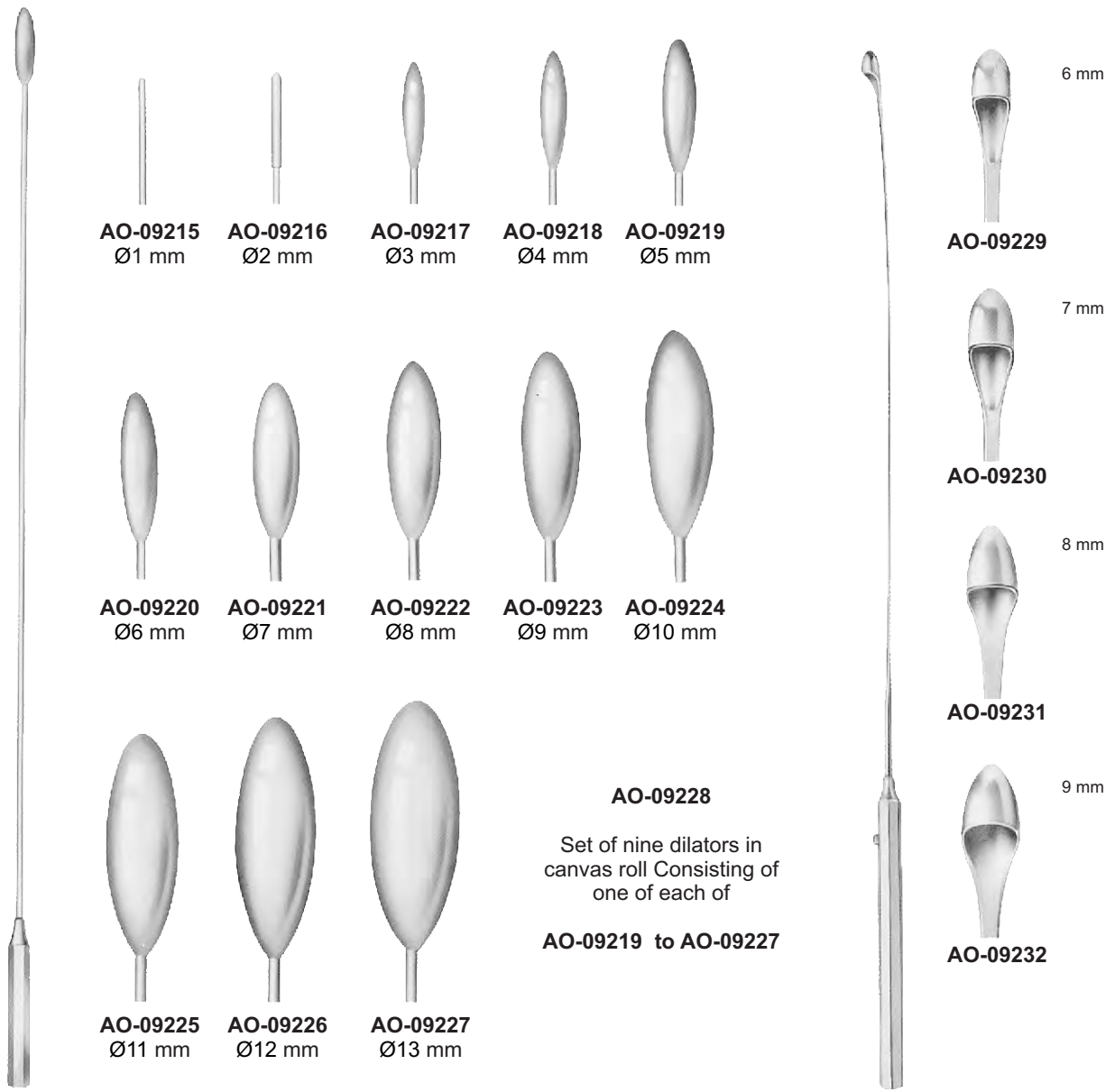

AO-09215
Ø1 mm

AO-09216
Ø2 mm

AO-09217
Ø3 mm

AO-09218
Ø4 mm

AO-09219
Ø5 mm

AO-09229

6 mm

AO-09220
Ø6 mm

AO-09221
Ø7 mm

AO-09222
Ø8 mm

AO-09223
Ø9 mm

AO-09224
Ø10 mm

AO-09230

7 mm

AO-09225
Ø11 mm

AO-09226
Ø12 mm

AO-09227
Ø13 mm

AO-09228

Set of nine dilators in
canvas roll Consisting of
one of each of

AO-09219 to AO-09227

AO-09231

8 mm

AO-09232

9 mm

BAKES
300mm (12")

Common bile duct dilators, malleable

DESJARDINS
300mm (12")

Probe and catch
with flexible shaft

INSTRUMENTS

GALL STONE SCOOPS / FORCEPS

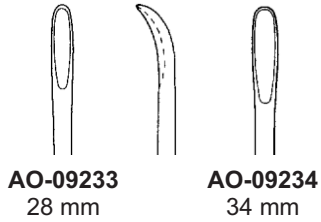

AO-09233
28 mm

AO-09234
34 mm

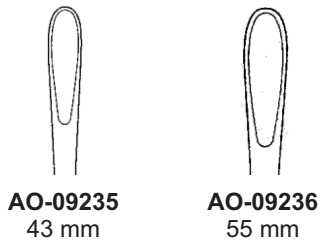

AO-09235
43 mm

AO-09236
55 mm

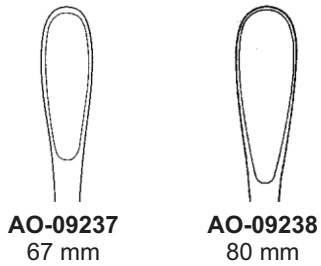

AO-09237
67 mm

AO-09238
80 mm

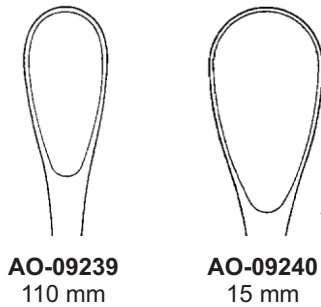

AO-09239
110 mm

AO-09240
15 mm



AO-09241

AO-09242

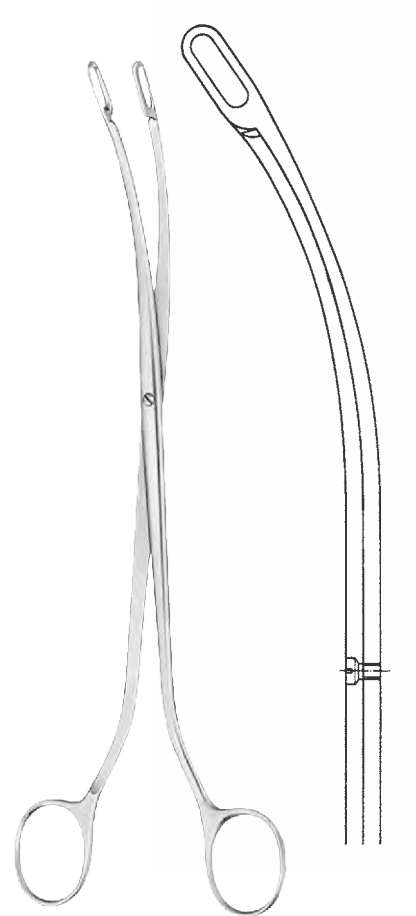

DESJARDINS
225mm (9")

SCOOP
310mm (12")

With malleable shaft



CHOLECYSTECTOMY AND GALL STONE FORCEPS



BLAKE

AO-09243
205mm (8")
Straight



BLAKE

AO-09244
205mm (8")
Curved

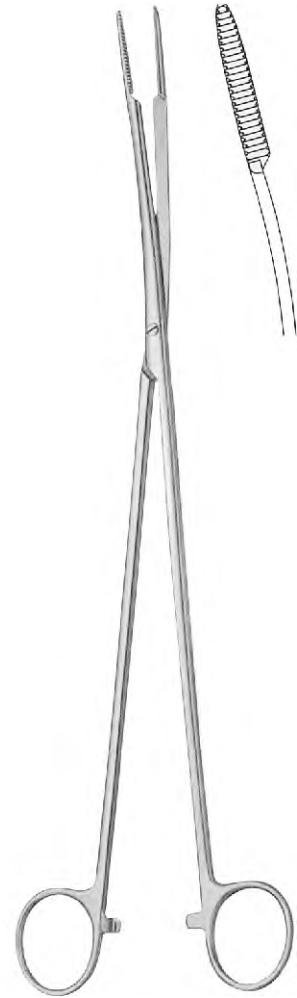

**DUCT DISSECTING / DILATING
FORCEPS**

AO-09245
260mm (10 1/4")

CHOLECYSTECTOMY AND GALL STONE FORCEPS

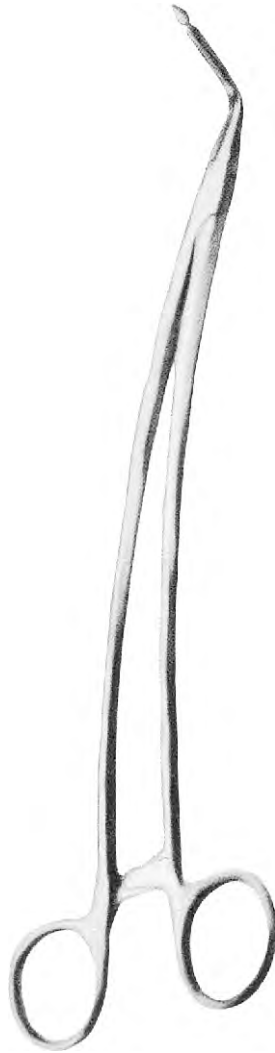

**CHOLANGIOGRAM CANNULA
INTRODUCING FORCEPS**

AO-09246
280mm (11")
Grooved jaw, for use with
Stoke - on - Trent Cannula



INTESTINAL CLAMPS



DOYEN
165mm (6 1/2")
Spring blades

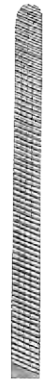

AO-09301
Straight



AO-09302
Curved



AO-09305
Straight

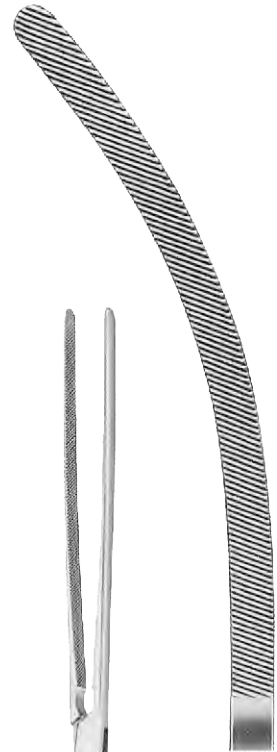

AO-09306
Curved



DOYEN
170mm (6 3/4")
Spring blades



AO-09303
Straight

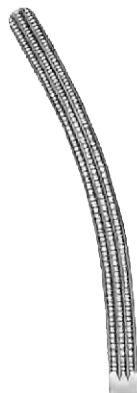

AO-09304
Curved

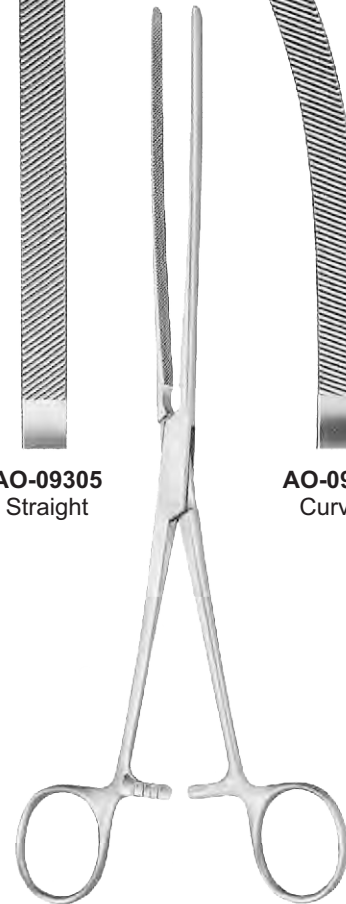

DOYEN
235mm (9 3/4")
Spring blades

INTESTINAL CLAMPS



DOYEN
230mm (9")
Spring blades

AO-09307
Straight

AO-09308
Curved



DOYEN (KOCHER)
Straight, light spring blade

AO-09309
230mm (9")

AO-09310
250mm (10")

AO-09311
280mm (11")

AO-09312
210mm (8 1/4")



DOYEN (MAYO ROBSON)
Curved, light spring blade

AO-09313
230mm (9")

AO-09314
250mm (10")

AO-09315
280mm (11")

AO-09316
210mm (8 1/4")



INTESTINAL CLAMPS



KOCHER
Spring blades

AO-09317
250mm (10")

AO-09318
280mm (11")

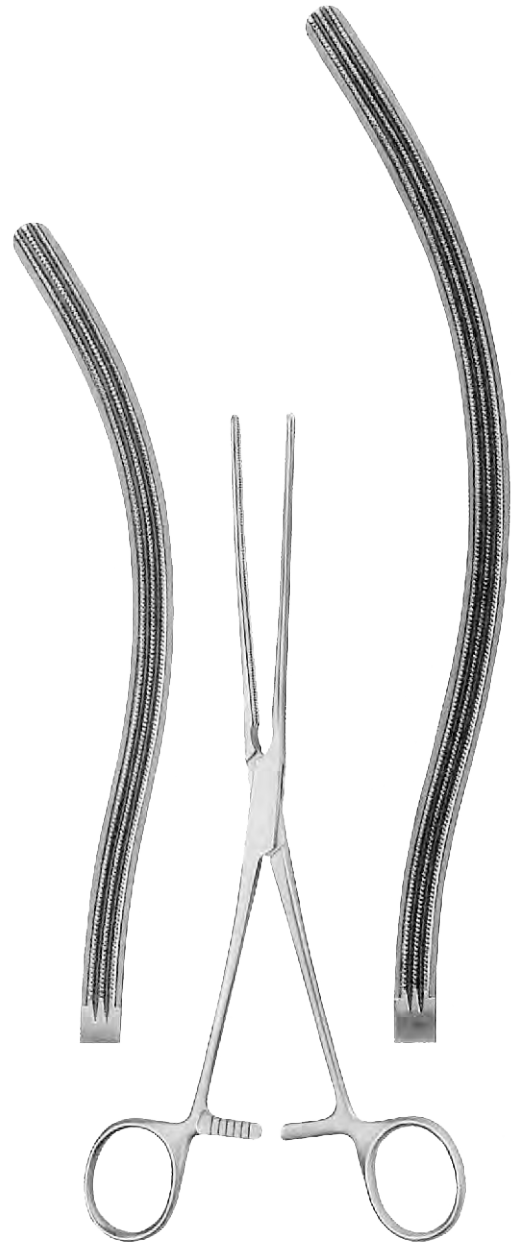

DOYEN (MAYO ROBSON)
Spring blades

AO-09319
250mm (10")

AO-09320
280mm (11")



INTESTINAL CLAMPS

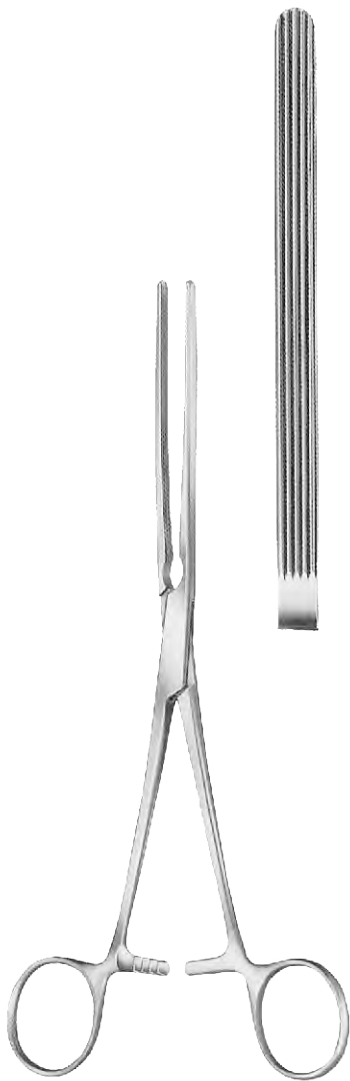

LANE

AO-09321
210mm (8 1/4")



**SETON PRINGLE
(BAINBRIDGE)**

AO-09322
150mm (6") Straight

AO-09323
150mm (6") Curved





INTESTINAL CLAMPS



SCHOEMAKER
Hollow blades for
hemisphincterectomy

AO-09325
170mm (63/4")

AO-09326
215mm (81/2")



PARKER KERR
Anastomosis forceps for
colon resection

AO-09327
250mm (10")

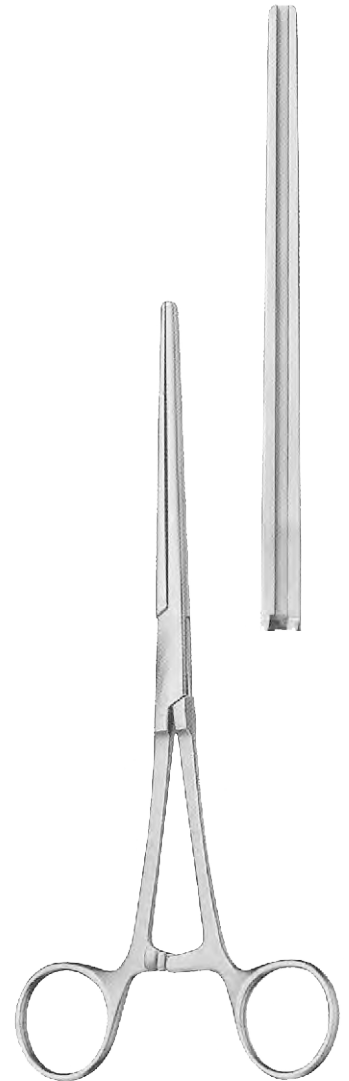

LANG STEVENSON

AO-09328
200mm (8")

INTESTINAL CLAMPS



LLOYD DAVIS RECTAL OCCLUSION

AO-09335
315mm (12 1/2")
Angleg



RESANO

AO-09336
265mm (10 1/2")
Colon resection clamp



INTESTINAL CLAMPS



PAYR

AO-09331
200mm (8")
Jaw: 65mm

AO-09332
280mm (11")
Jaw: 100mm

AO-09333
350mm (14")
Jaw: 150mm



FINCH EXCISION

AO-09334
230mm (9")
Angled



INTESTINAL CLAMPS



LANE TWIN ANASTOMOSIS

AO-09329
300mm (12") Curved



LANE TWIN ANASTOMOSIS

AO-09330
300mm (12") Straight





INTESTINAL CLAMPS



HAYES
70 degree angled jaw
Colon resection clamp

AO-09337
265mm (10 1/2")
Jaw: 80mm

AO-09338
280mm (11")
Jaw: 100mm

VAGINAL SPECULUM

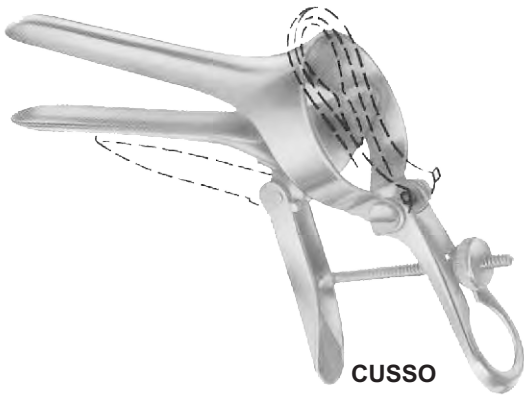

CUSCO
AT-09400
 75mm x 17mm
 Extra small for virgins

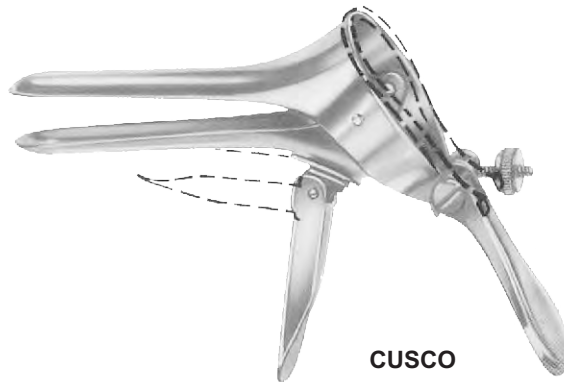

CUSCO
AT-09401
 75mm x 17mm
 Extra small for virgins

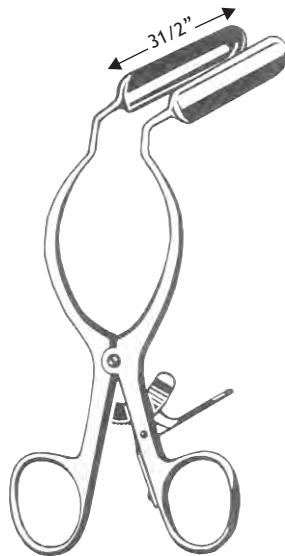

**McGEE LATERAL
 VIGINAL RETRACTOR**
 with ratch handle
AT-09405



CUSCO
AT-09402 110mm x 37mm
AT-09403 80mm x 32mm
AT-09404 80mm x 24mm

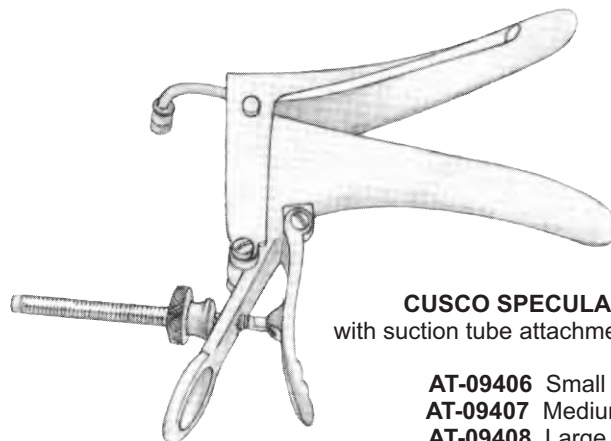

CUSCO SPECULAM
 with suction tube attachment black
AT-09406 Small
AT-09407 Medium
AT-09408 Large



VAGINAL SPECULUM



GRAVE

- AT-09409** 75mm x 20mm
- AT-09410** 95mm x 30mm
- AT-09411** 195mm x 33mm



PEDERSON

- AT-09412** 100mm x 22 mm
- AT-09413** 120mm x 25mm



SIMS

- AT-09414**
125mm (5")
Small
70mm x 26mm
75mm x 30mm

- AT-09415**
150mm (6")
Medium
75mm x 30mm
80mm x 35mm

- AT-09416**
175mm (7")
Large
80mm x 36mm
90mm x 40mm

VAGINAL SPECULUM

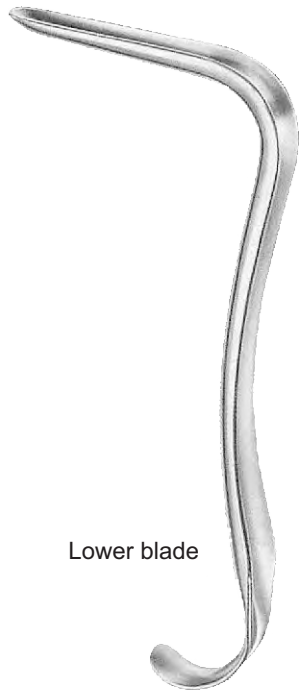

Lower blade



Upper blade

AT-09417
175mm (7")
Blade:
70mm x 15mm

AT-09421
175mm (7")
Blade:
70mm x 10mm

AT-09418
180mm (7")
Blade:
70mm x 27mm

AT-09422
180mm (7")
Blade:
75mm x 23mm

AT-09419
180mm (7")
Blade:
75mm x 30mm

AT-09423
180mm (7")
Blade:
80mm x 25mm

AT-09420
185mm (7 1/4")
Blade:
90mm x 36mm

AT-09424
185mm (7 1/4")
Blade:
100mm x 32mm

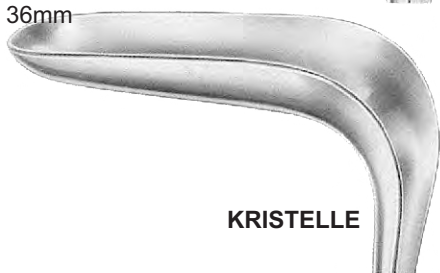

KRISTELLE



KRISTELLE



VAGINAL SPECULUM



MATHIEU
AT-09425
210mm (8 1/4")
Blade:
95mm x 17-30mm
For children and virgins



MODIFIED WERTHEIM
320mm (12 3/4")

AT-09432
Blade: 100mm x 25mm

AT-09433
Blade: 100mm x 30mm

AT-09434
Blade: 100mm x 35mm

AT-09435
Blade: 100mm x 40mm



KOGAN ENDOCERVICAL SPECULUM

AT-09436
240mm (9 1/2")
Graduated

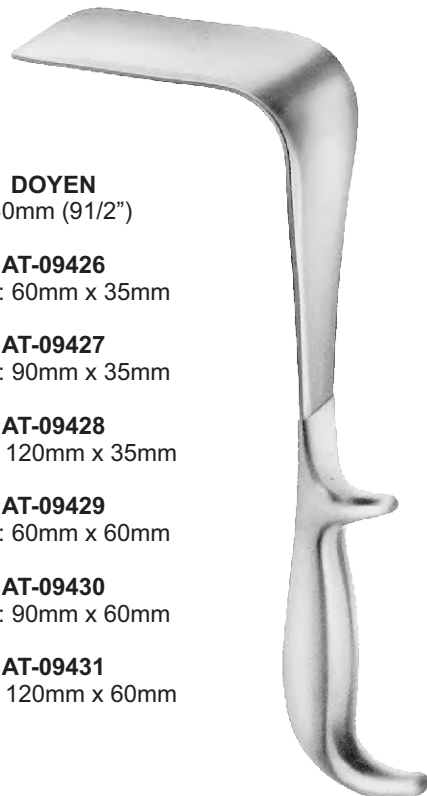

DOYEN
240mm (9 1/2")

AT-09426
Blade: 60mm x 35mm

AT-09427
Blade: 90mm x 35mm

AT-09428
Blade: 120mm x 35mm

AT-09429
Blade: 60mm x 60mm

AT-09430
Blade: 90mm x 60mm

AT-09431
Blade: 120mm x 60mm

VAGINAL SPECULUM

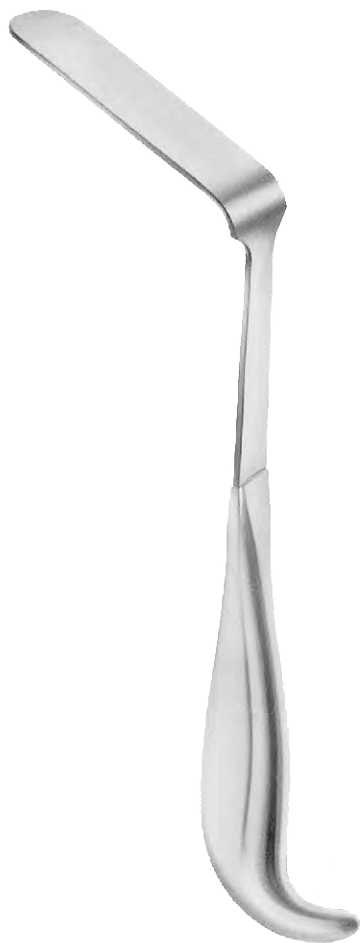

MODIFIED DOYEN
AT-09437
250mm (10")
Blade: 80mm x 30mm
Lateral Speculum



AT-09439

AT-09438

SIMON
275mm (10 3/4")

AT-09438
Blade: 115mm X 26mm

AT-09439
Blade: 115mm x 22mm



VAGINAL RETRACTOR/ UTERINE DILATORS

AUVARD

AT-09440
230mm (9")
Blade: 63mm x 38-28mm
Weight: 153 Kg (3lb, 60z)
Fixed weight

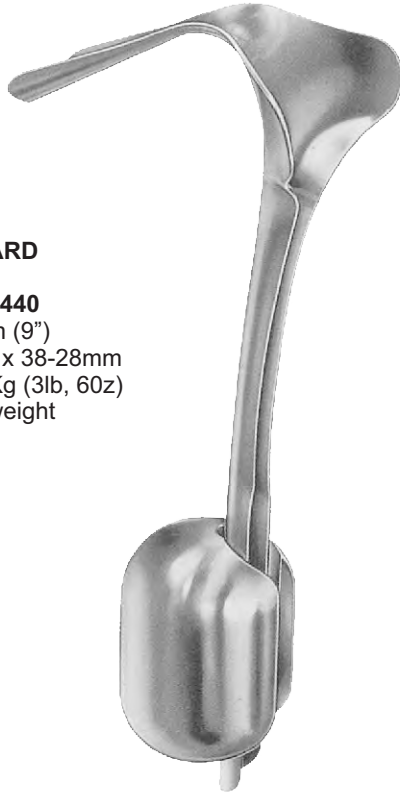

AUVARD

230mm (9")
Weight: 147kg (3lb, 4oz)
with detachable weight

AT-09441
Blade: 75mm x 42-40mm

AT-09442
Blade: 105mm x 43-40mm

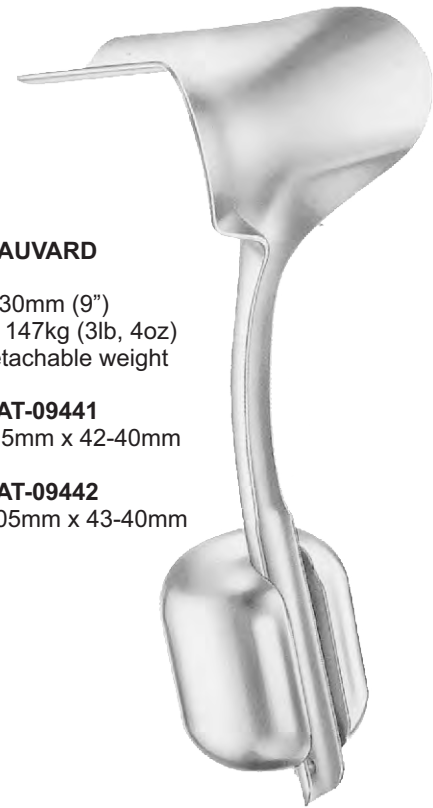

O6-09443

Set of twelve

- AT-09444 6mm
- AT-09445 7mm
- AT-09446 8mm
- AT-09447 9mm
- AT-09448 10mm
- AT-09449 11mm
- AT-09450 12mm
- AT-09451 13mm
- AT-09452 14mm
- AT-09453 15mm
- AT-09454 16mm
- AT-09455 17mm

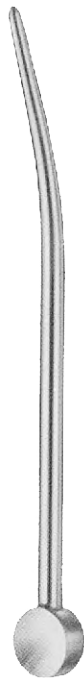

HAWKIN AMBLER

170mm (63/4")
Cervix dilator



AT-09456

Set of sixteen
consisting of one of
each of: 09457 to 09472

- | | | |
|---------------|---------------|----------------|
| AT-09457 2mm | AT-09468 13mm | AT-09479 85mm |
| AT-09458 3mm | AT-09469 14mm | AT-09480 95mm |
| AT-09459 4mm | AT-09470 15mm | AT-09481 105mm |
| AT-09460 5mm | AT-09471 16mm | AT-09482 115mm |
| AT-09461 6mm | AT-09472 17mm | AT-09483 125mm |
| AT-09462 7mm | AT-09473 25mm | AT-09484 135mm |
| AT-09463 8mm | AT-09474 35mm | AT-09485 145mm |
| AT-09464 9mm | AT-09475 45mm | AT-09486 155mm |
| AT-09465 10mm | AT-09476 55mm | AT-09487 165mm |
| AT-09466 11mm | AT-09477 65mm | AT-09488 175mm |
| AT-09467 12mm | AT-09478 75mm | |

HEGAR

185mm (71/4")
Cervix dilator

UTERINE DILATORS / PROBES



HEGAR
205mm (8")
Cervix dilator
Double ended

AT-09489
Set of eight consisting
of one of each of:
09491 to 09498

- AT-09490 1mm - 2mm
- AT-09491 3mm - 4mm
- AT-09492 5mm - 6mm
- AT-09493 7mm - 8mm
- AT-09494 9mm - 10mm
- AT-09495 11mm - 12mm
- AT-09496 13mm - 14mm
- AT-09497 15mm - 16mm
- AT-09498 17mm - 18mm



GALABIN

AT-09499
290mm (11 1/2")
Shaft graduated
is cm's
Malleable

4mm



SIMS

AT-09500
330mm (13")

AT-09501
330mm (13")
Malleable

3mm



MARTIN

AT-09502
300mm (12")



DRESSING FORCEPS



BROWN
AT-09503
270mm (103/4")
Uterine depressor

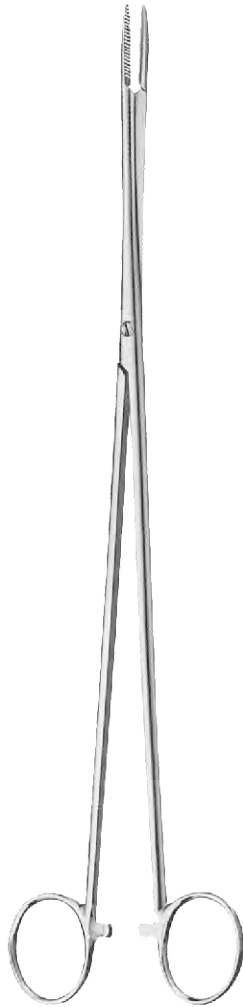

PELKMANN
Straight
AT-09504
260mm (101/4")

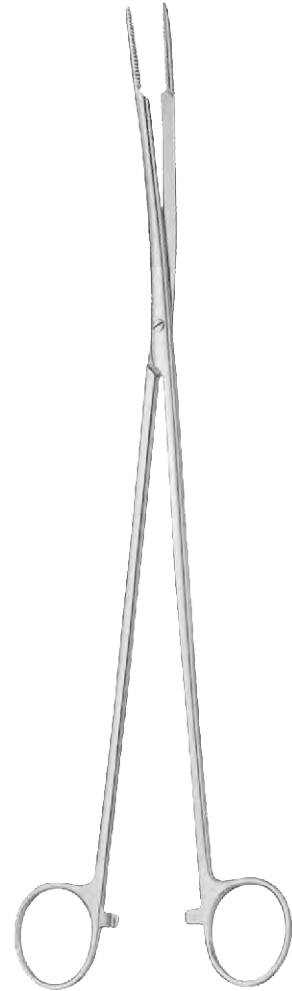

PELKMANN
Curved
AT-09505
260mm (101/4")

TENACULUM FORCEPS

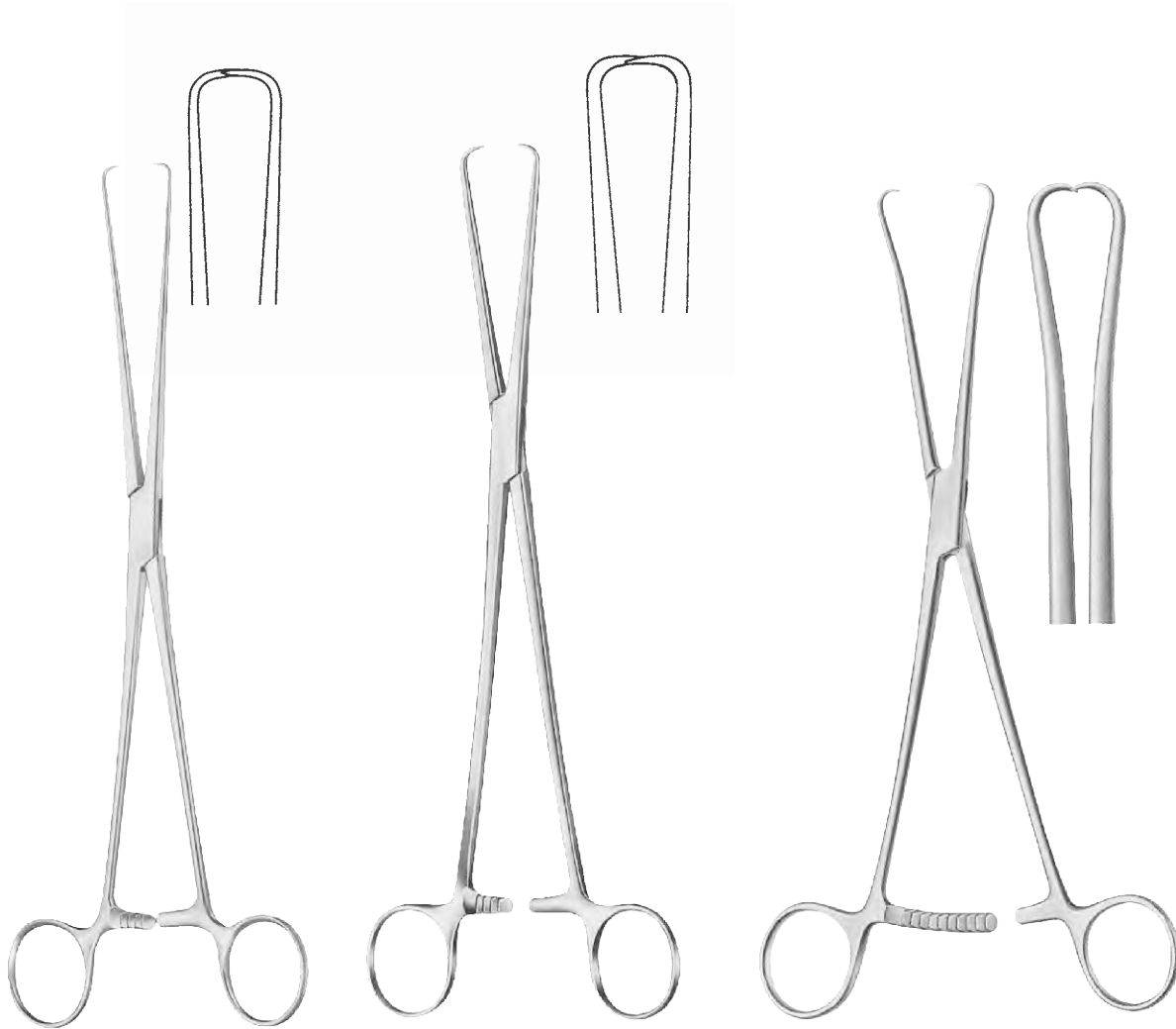

BROWN

AT-09506
250mm (10")
Slender

SCHROEDER

AT-09507
230mm (9")

WILSON

AT-09508
240mm (9 1/2")



TENACULUM FORCEPS

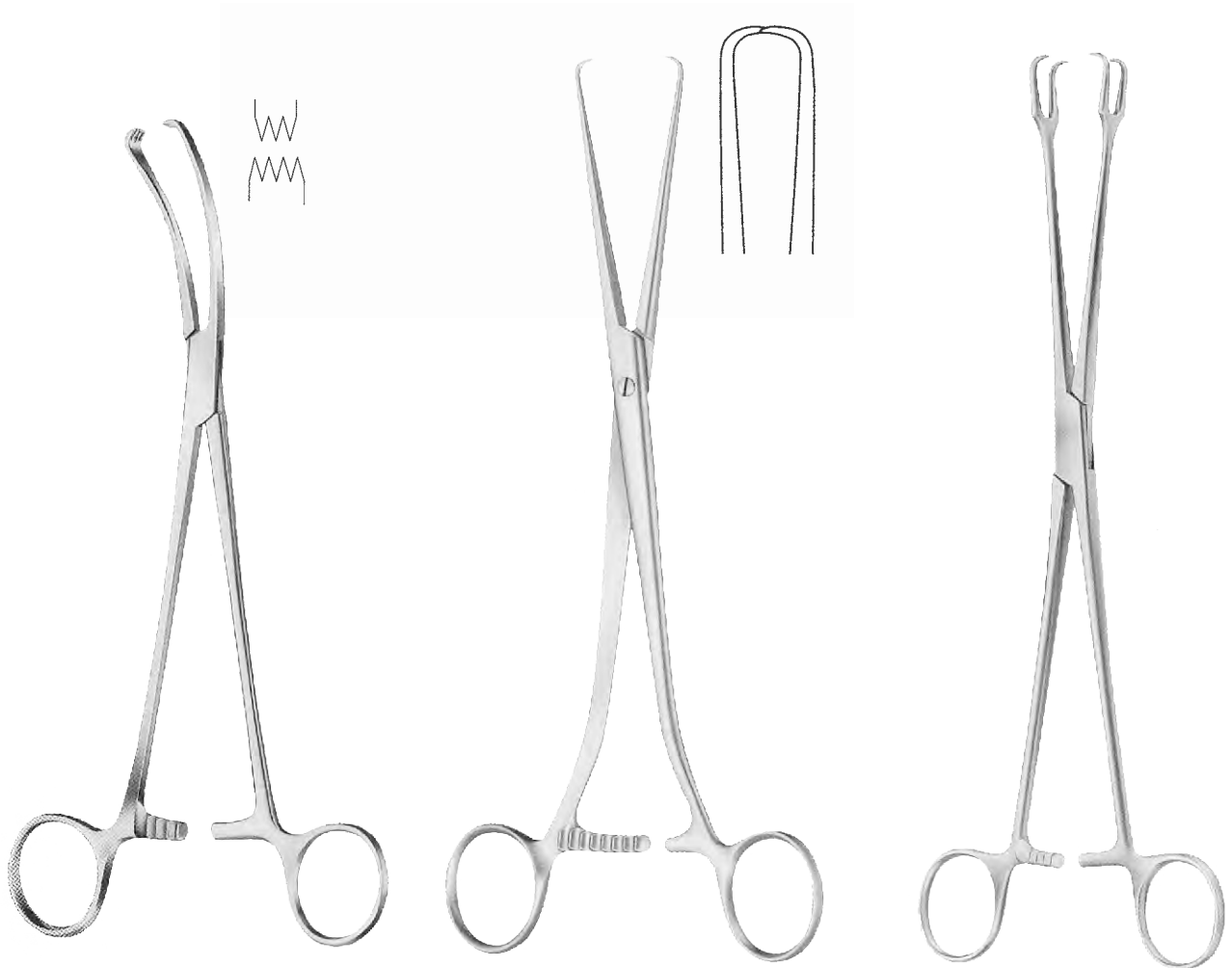

TEALE

AT-09509
3 x 4 teeth
230mm (9") Curved

AT-09510
230mm (9") Straight

AT-09511
180mm (7") Curved

ROTUNDA

AT-09512
265mm (10 1/2")

SCHROEDER

AT-09513
250mm (10")

TENACULUM FORCEPS



JACOBS
AT-09514
215mm (8 1/2")

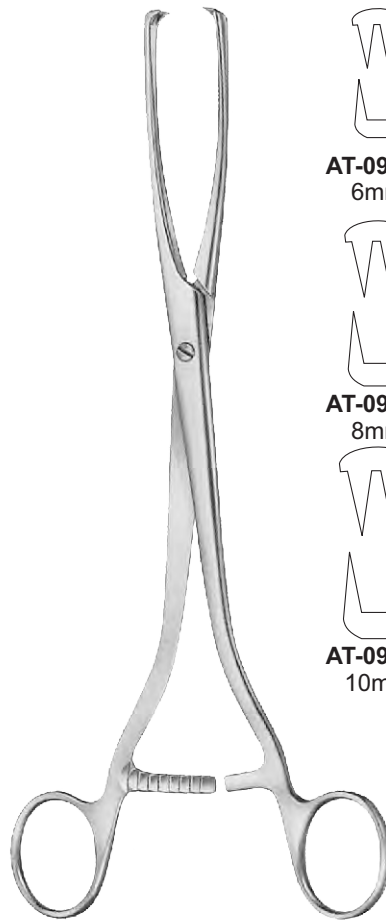

AT-09515
6mm

AT-09516
8mm

AT-09517
10mm

MUSEUX
240mm (9 1/2")



OVUM FORCEPS

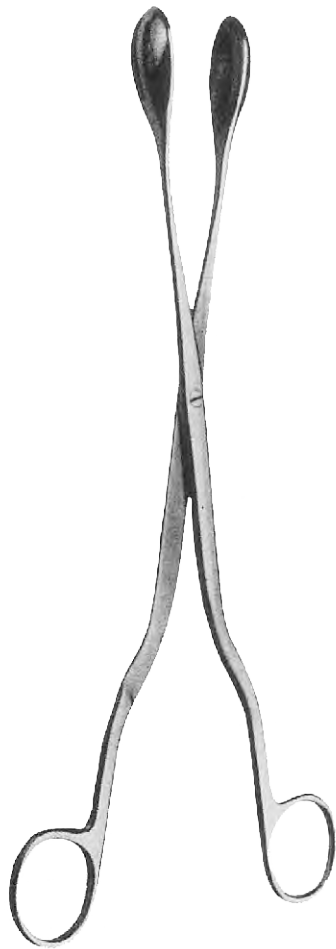

HEYWOOD SMITH

AT-09518
240mm (9 1/2")

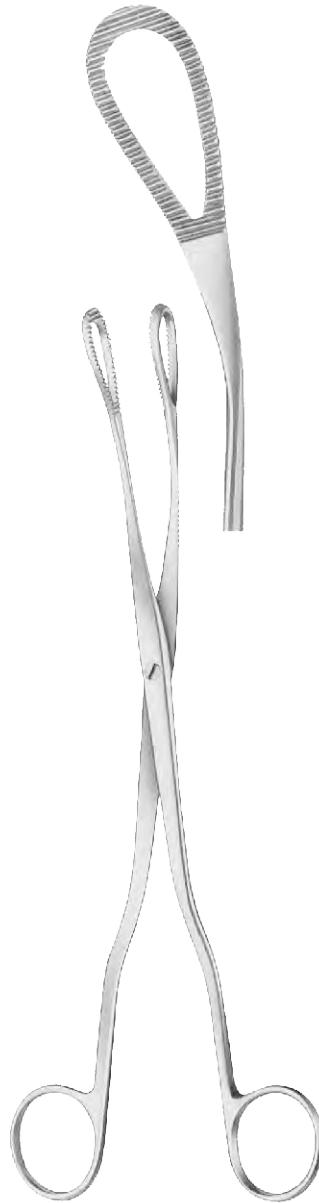

MCLINTOCK

AT-09519
240mm (9 1/2")

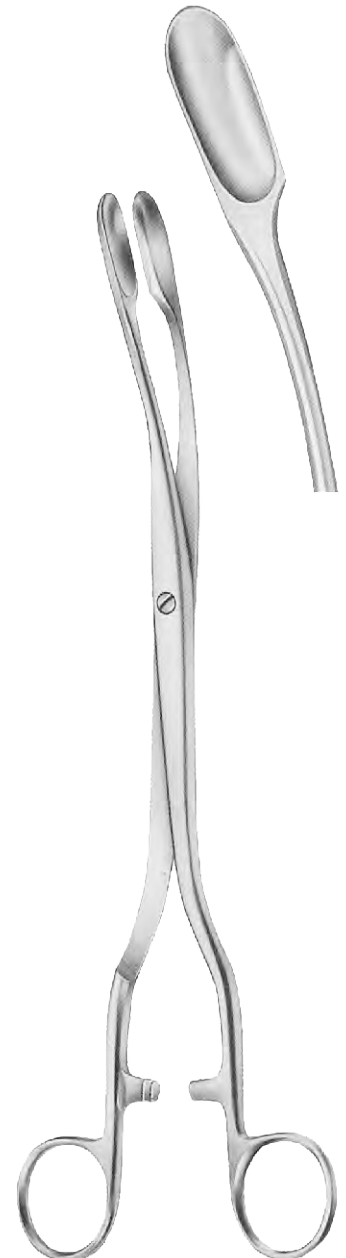

NOTO

AT-09520
280mm (11")



OVUM FORCEPS

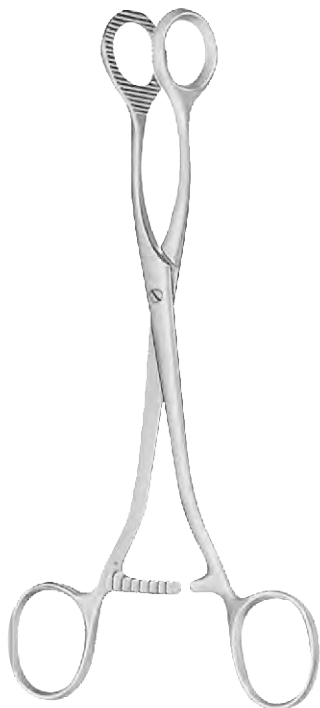
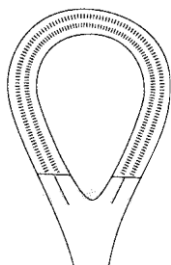

DOYEN
AT-09521
185mm (7 1/4")



AT-09522
250mm (10")

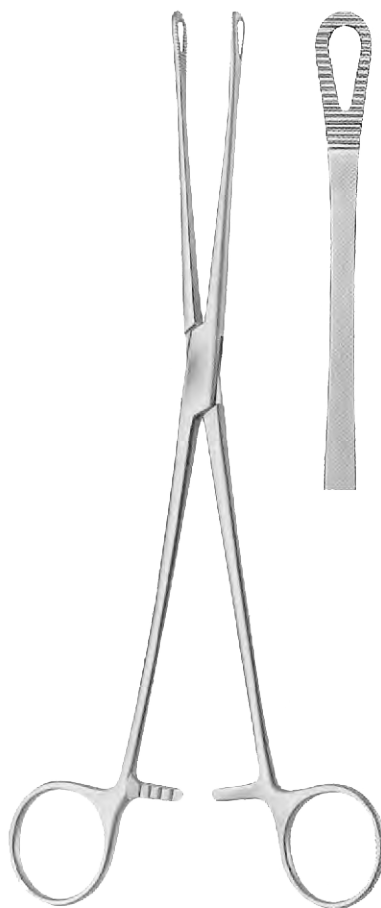

BONNEY POLYPI
AT-09523
240mm (9 1/2")





UTERINE ELEVATOR FORCEPS



SOMER
AT-09524
235mm (9 3/4")



DARTIGUES
AT-09525
255mm (10")

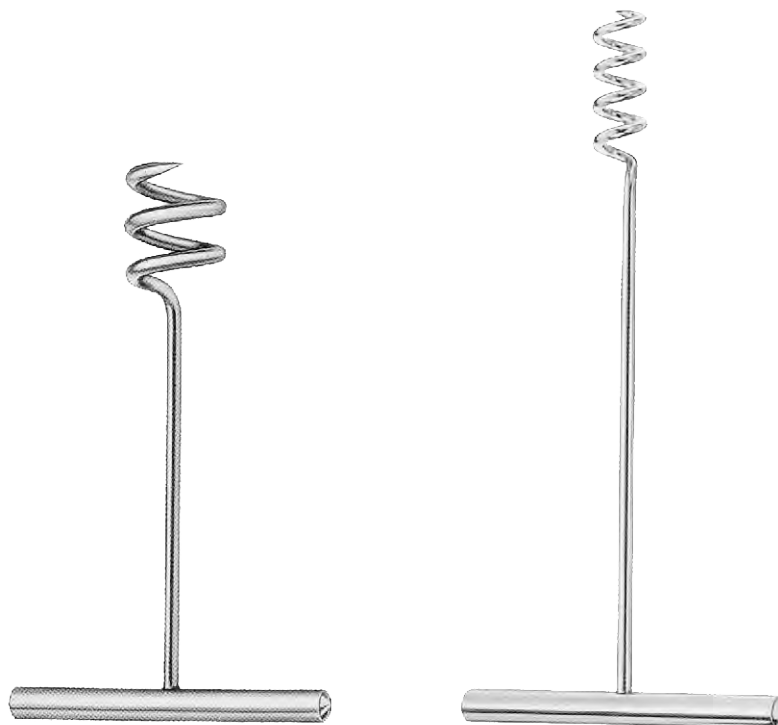

DOYEN

AT-09526
150mm (6")
Abdominal

DOYEN

AT-09527
190mm (7 1/2")
Vaginal



CERVICAL BIOPSY FORCEPS & CURETTES

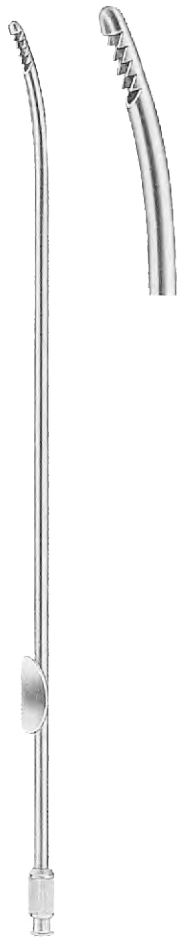

**ENDOMETRIAL
BIOPSY CURETTE**

AT-09528
240mm (9 1/2")



SHARMAN

AT-09529
270mm (10 3/4")

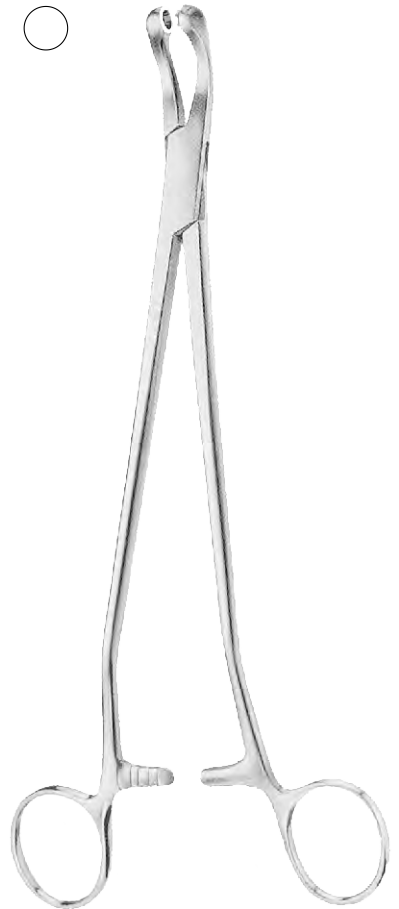

THOMS-GAYLOR

AT-09530
240mm (9 1/2")

CERVICAL BIOPSY FORCEPS

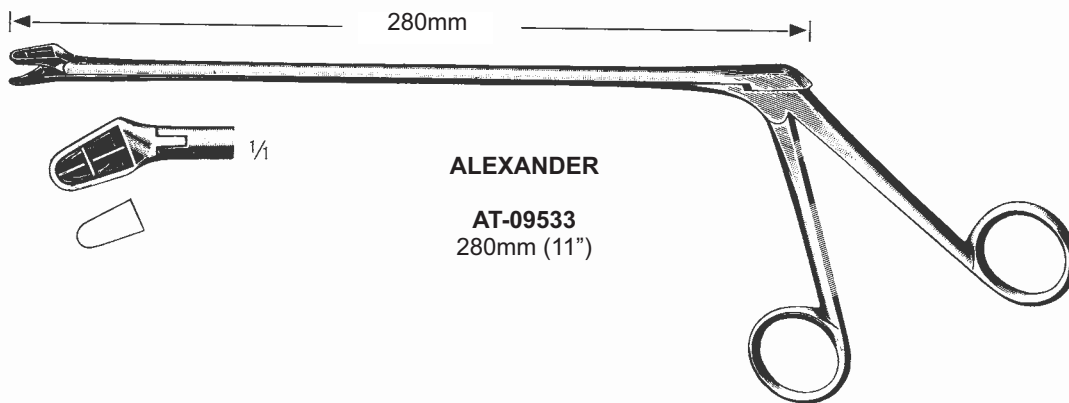
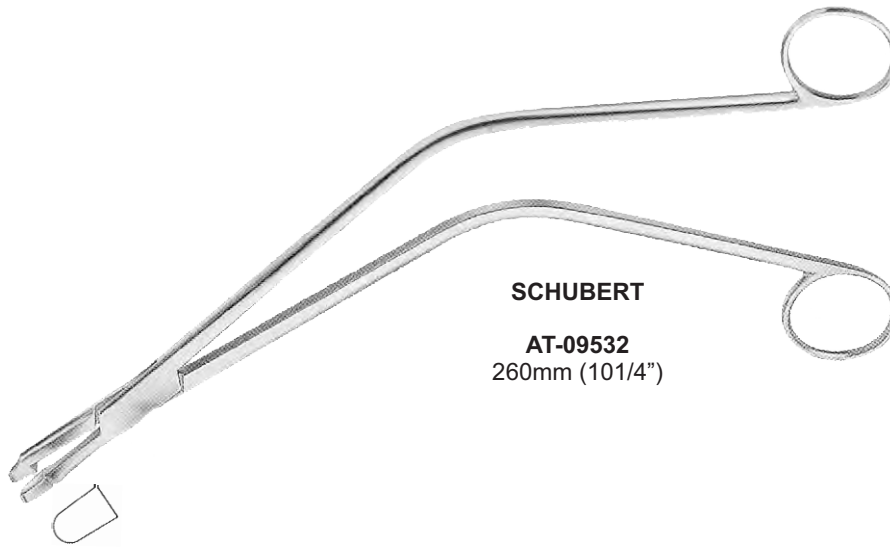
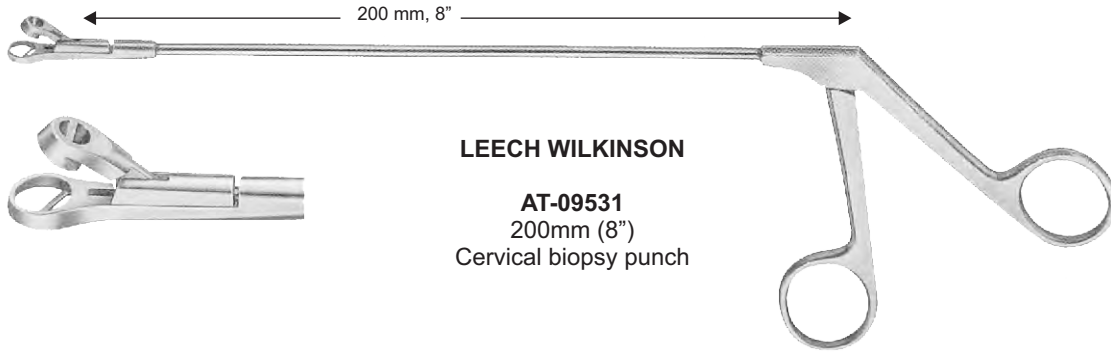



CERVICAL BIOPSY FORCEPS

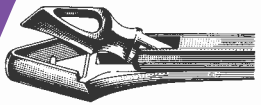

240mm

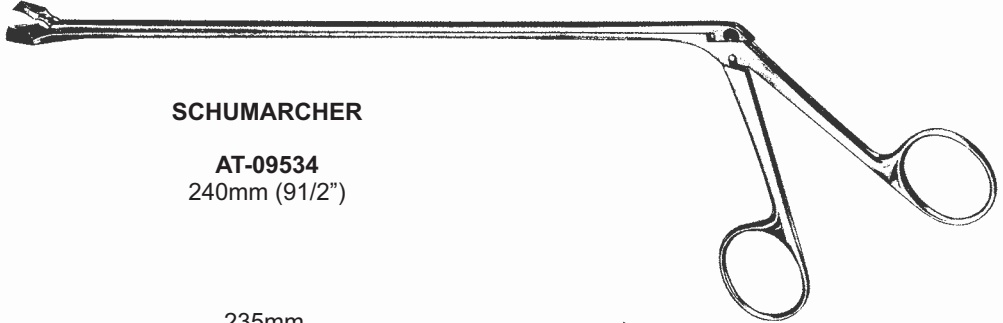

SCHUMARCHER
AT-09534
240mm (9 1/2")



235mm

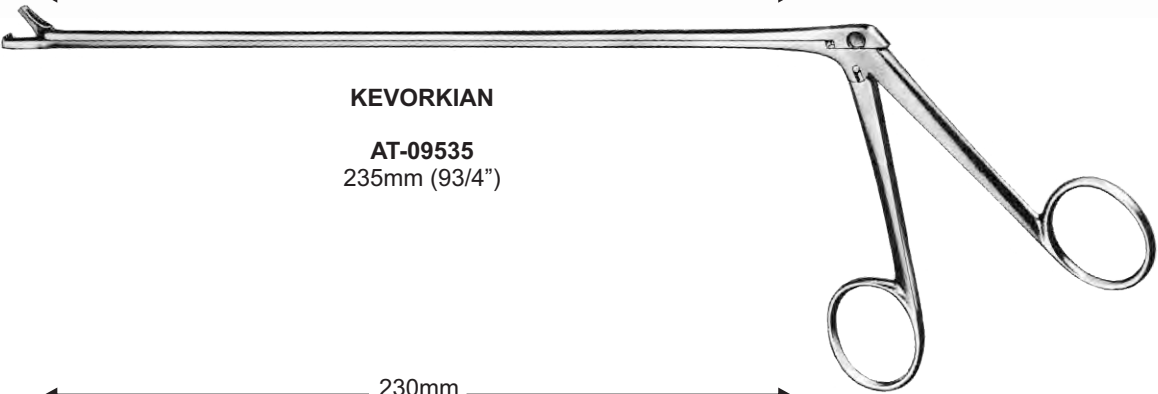

KEVORKIAN
AT-09535
235mm (9 3/4")



230mm

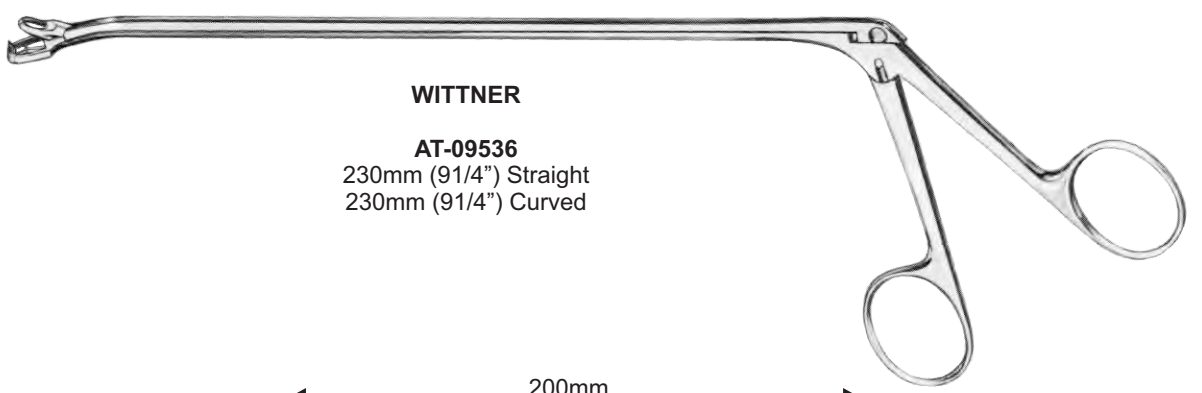

WITTNER
AT-09536
230mm (9 1/4") Straight
230mm (9 1/4") Curved



200mm



TISCHLER-MORGAN
AT-09537
200mm (8")

INSTRUMENTS

CERVICAL BIOPSY FORCEPS



OVAL
7 x 5 mm

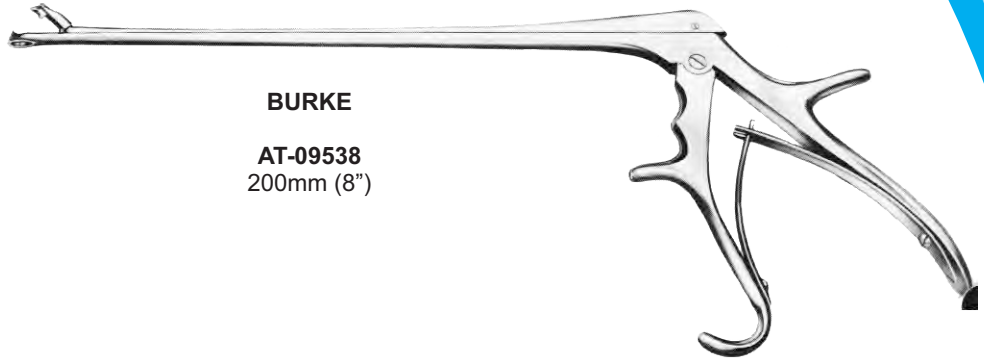

BURKE
AT-09538
200mm (8")



TISHLER-MORGAN

Fig1

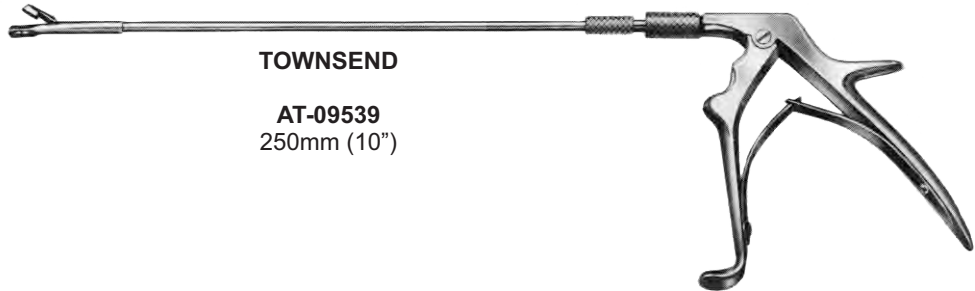

TOWNSEND
AT-09539
250mm (10")



OVAL
37 x 5mm

Fig3



MINI

Fig5



KEVORKIAN

Fig4



3 x 8 mm

KEVORKIAN

AT-09540
250mm (10")



CERVICAL BIOPSY FORCEPS

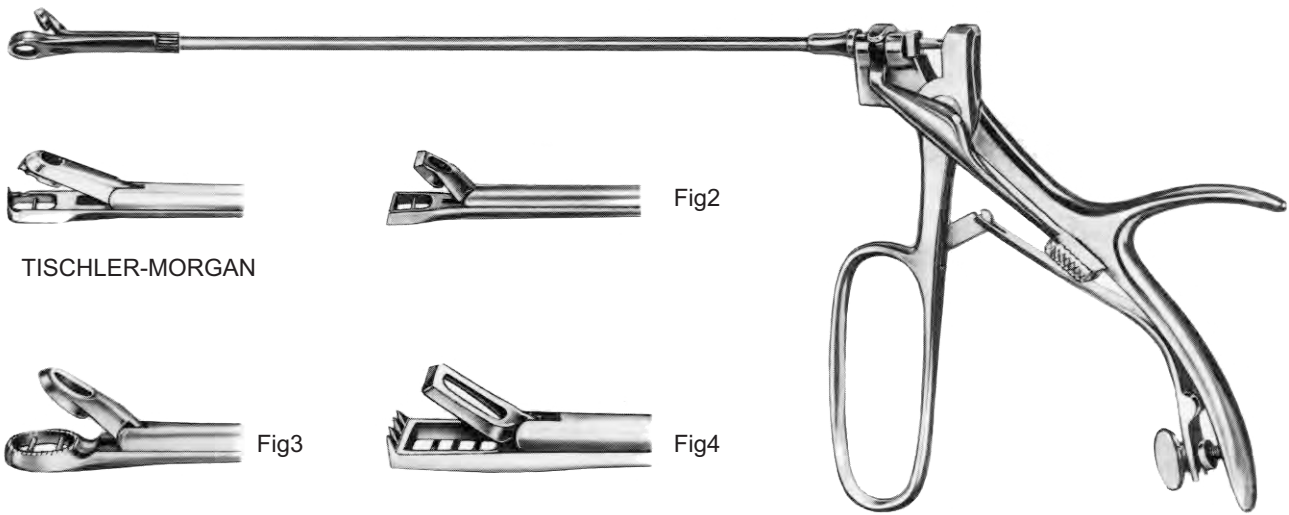

TISCHLER-MORGAN

Fig2

Fig3

Fig4

EPPENDORFER

AT-09544
230mm (8 1/2")

CERVICAL BIOPSY FORCEPS



AT-09545
140mm (5 1/2")
Pistol Grip



AT-09546
140mm (5 1/2")
Pistol grip



Shaft only
AT-09547 200mm (8")
AT-09548 250mm (10")

Biopsy cutting



AT-09549 ⊕

AT-09550 ⊕



AT-09551 ⊕



AT-09552 △



UTERINE SCOOPS AND CURETTES



AT-09553
68mm

AT-09554
85mm

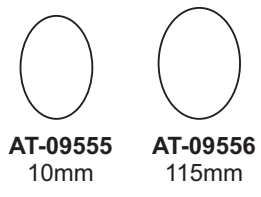

AT-09555
10mm

AT-09556
115mm

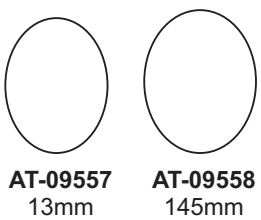

AT-09557
13mm

AT-09558
145mm



SIMON
240mm (9 1/2")

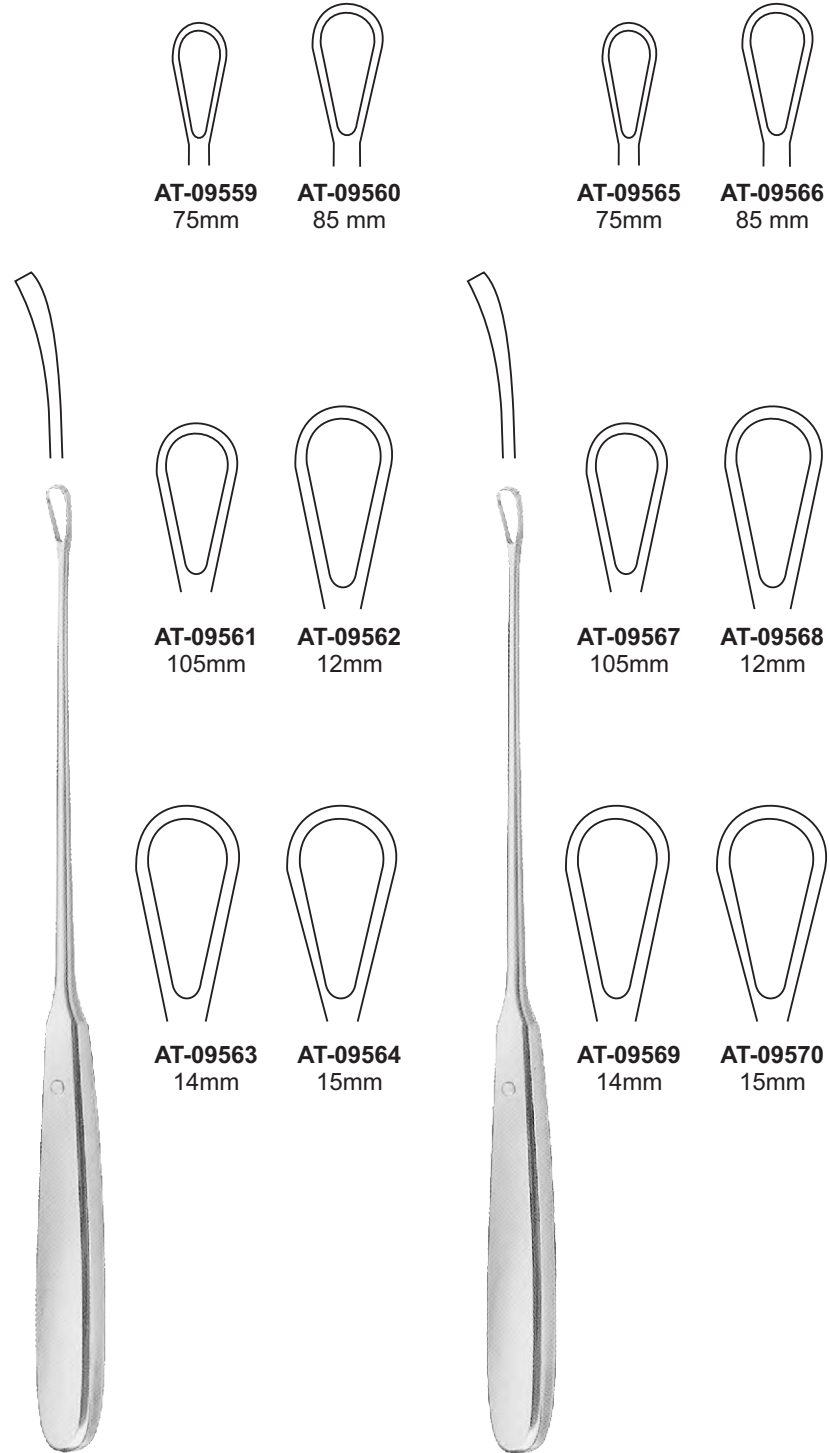

AT-09559
75mm

AT-09560
85 mm

AT-09565
75mm

AT-09566
85 mm

AT-09561
105mm

AT-09562
12mm

AT-09567
105mm

AT-09568
12mm

AT-09563
14mm

AT-09564
15mm

AT-09569
14mm

AT-09570
15mm



SIMS
255mm (10")
Rigid, sharp

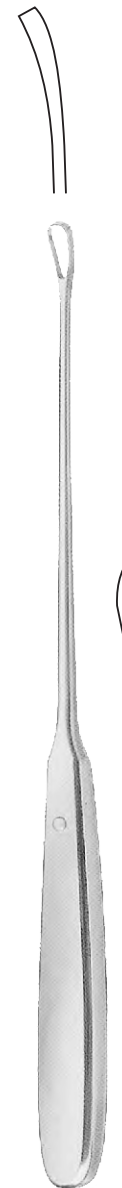

SIMS
255mm (10")
Malleable, Sharp

INSTRUMENTS

UTERINE CURETTES





AT-09571
75mm



AT-09572
85mm





AT-09577
45mm



AT-09578
75mm

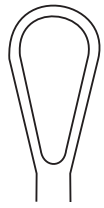

AT-09579
85mm

AT-09573
105mm



AT-09574
12mm



AT-09580
105mm

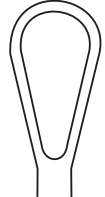

AT-09581
12mm

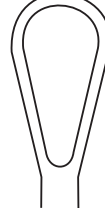

AT-09582
14mm

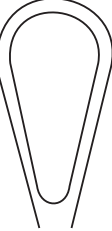
AT-09575
14mm

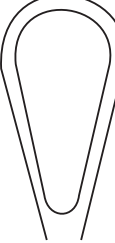

AT-09576
15mm



AT-09583
15mm

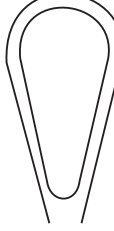

AT-09584
165mm

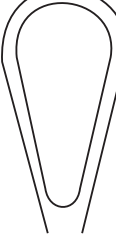

AT-09585
18mm

AT-09586
195mm

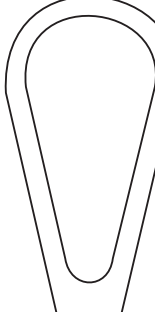

AT-09587
215mm

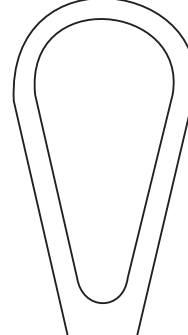

AT-09588
235mm

SIMS
255mm (10")
Malleable, blunt

300mm (12")
Sharp



UTERINE CURETTES



AT-09589
75mm



AT-09590
85mm



AT-09591
105mm



AT-09592
12mm

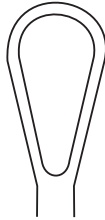

AT-09593
14mm

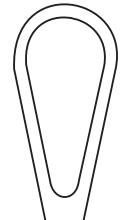

AT-09594
15mm

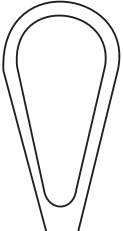

AT-09595
165mm

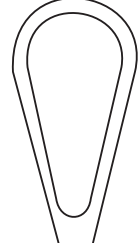

AT-09596
18mm

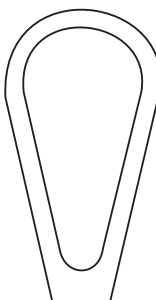

AT-09597
195mm

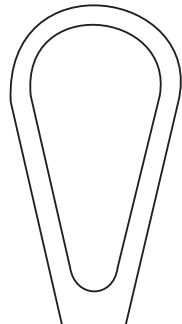

AT-09598
215mm

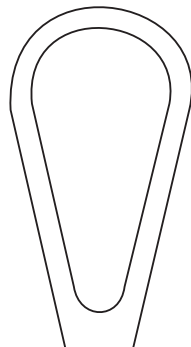

AT-09599
235mm



300mm (12")
Blunt



DOUBLE ENDED
250mm (93/4")
AT-09600 Sharp / blunt
AT-09601 Sharp / sharp

INSTRUMENTS

OBSTETRIC INSTRUMENTS



UTERINE FLUSHING TUBE

AT-09602
350mm (14")
Diameter: 10mm

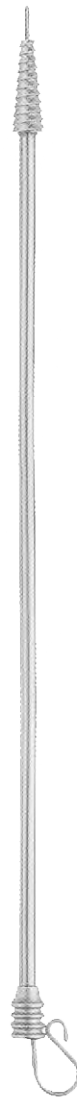

**LEECH-WILKINSON
INTRA-UTERINE CANNULA**

265mm (10 1/2")
With stilette



AT-09603
Small
Diameter 10 x 25mm



AT-09604
Medium
Diameter 13 x 30mm



AT-09605
Large
Diameter 16 x 30mm



GYNECOLOGY INSTRUMENTS



**SPACKMANN
INTRA-UTERINE CANNULA**

AT-09606
360mm (14 1/4")
With adjustable plate for
vulsellum forceps

OBSTETRICS INSTRUMENTS

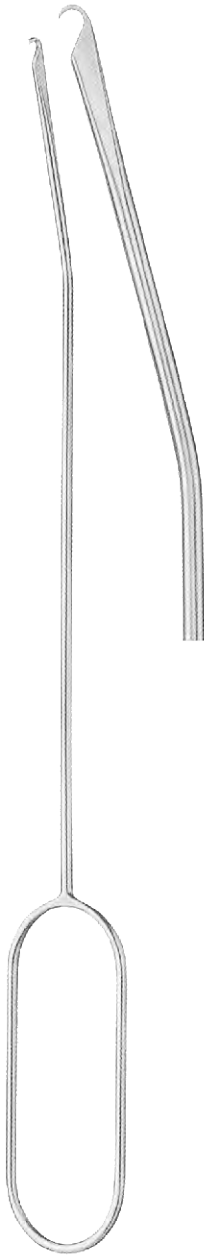

IUD REMOVING HOOK

AT-09607
320mm (12 1/2")

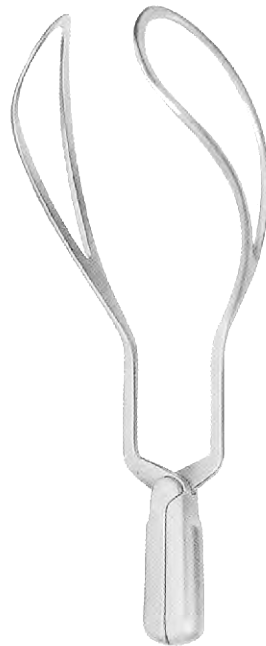

WRIGLEY

AT-09608
250mm (10")



KIELLAND

AT-09609
402mm (16 3/4")



UTERINE CANNULAE



BARNES
AT-09610
410mm (16")
With Simpson handles and
Neville axis traction rod

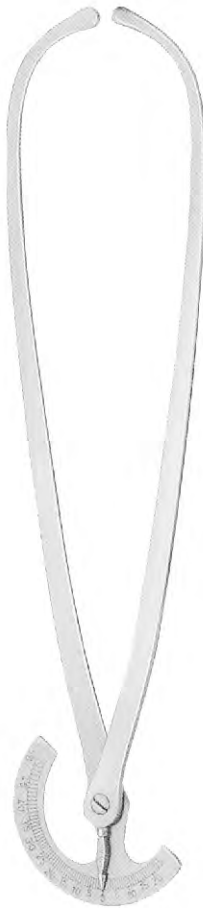

**FRENCH MODEL
PELVIMETER**
AT-09611
330mm (13")
External and internal
Graduated to 50 and
22cms



**VACUME
EXTRACTION
SUCTION HEAD**
AT-09612 40mm
AT-09613 50mm
AT-09614 60mm



AMNIOTOME
AT-09615
240mm (9 1/2")

UTERINE CANNULAE

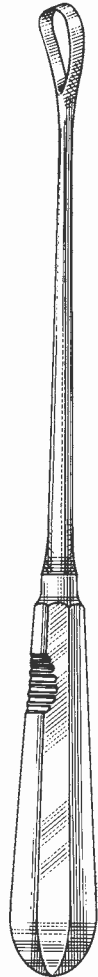
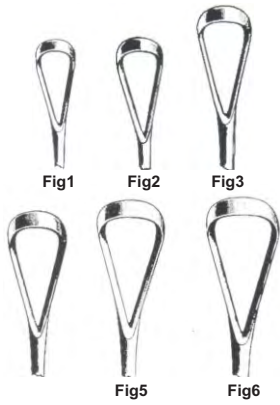

SIMS

AT-09616
280mm (11")



RECAMIER

AT-09617
310mm (13")



BUMM

AT-09618
280mm (11")



OBSTETRIC INSTRUMENTS

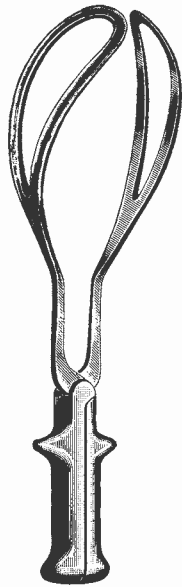

SIMPSON

AT-09620
300mm (12")

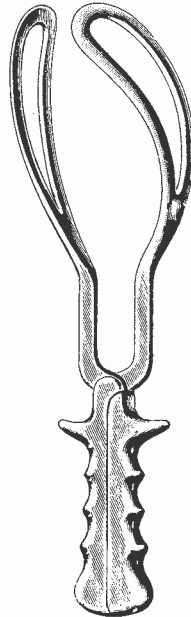

SIMPSON-BRAUN

AT-09621
330mm (13")

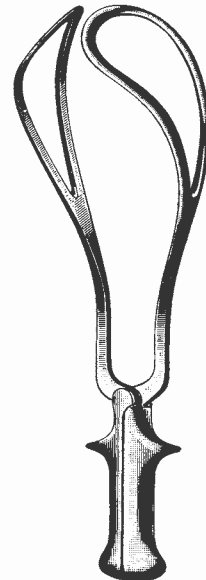

De LEE

AT-09622
300mm (12")

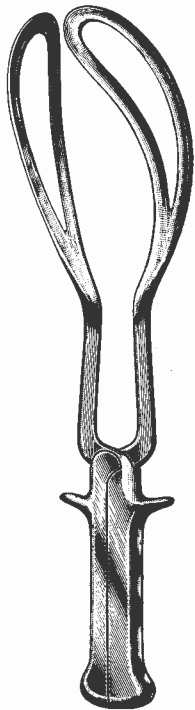

De LEE

AT-09623
360mm (14 1/2")

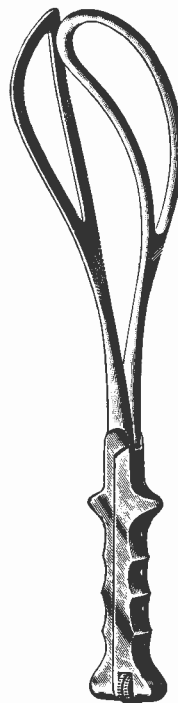

ELLIOT

AT-09624
320mm (12 1/2")

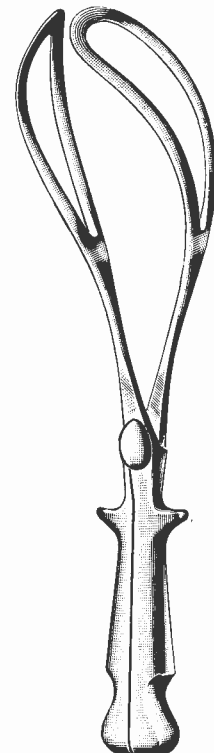

NAEGELE

AT-09625
360mm (14 1/2")

OBSTETRICS INSTRUMENTS

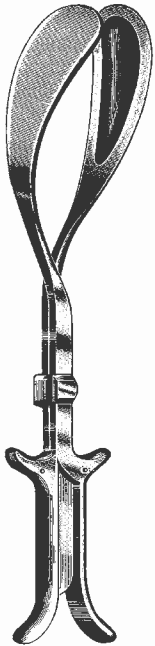

LUIKART

AT-09626
400mm (16")

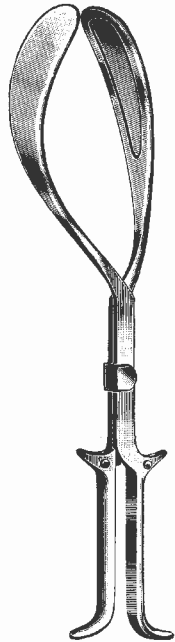

KIELLAND-LUIKART

AT-09627
400mm (16")

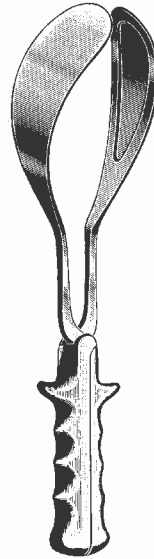

SIMPSON-LUIKART

AT-09628
360mm (14 1/2")

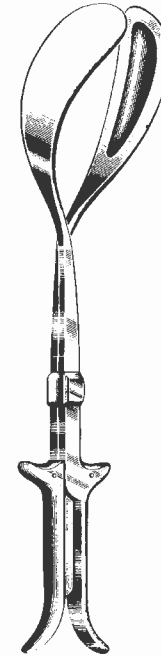

McLEAN-TUCKER-LUIKART

AT-09629
400mm (16")

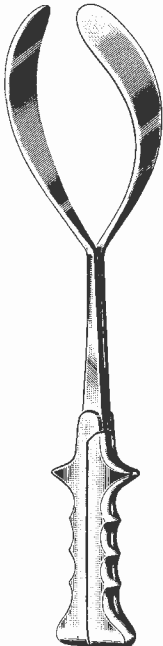

McLEAN-TUCKER

AT-09630
390mm (15 1/2")

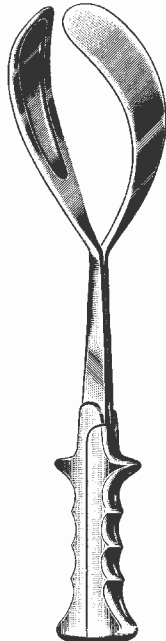

McLEAN-LUIKART

AT-09631
390mm (15 1/2")

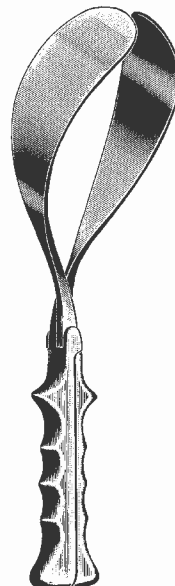

McLEAN

AT-09632
360mm (14 1/2")

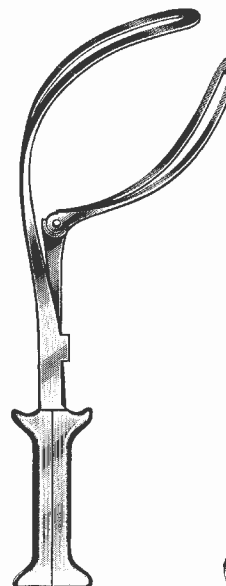

BARTON

AT-09633
360mm (14 1/2")

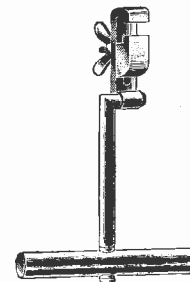

BARTON

AT-09634
170mm (6 3/4")



OBSTETRICS INSTRUMENTS

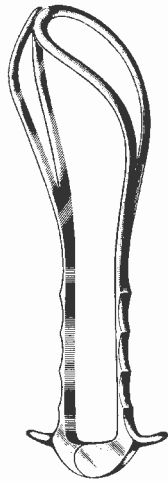

BOERMA
AT-09635
290mm (11 1/2")

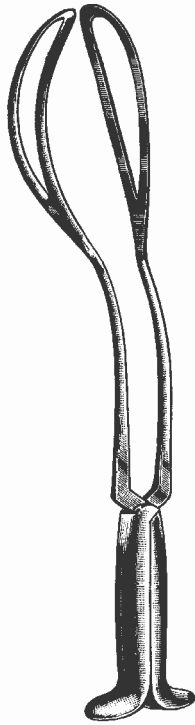

PIPER
AT-09636
440mm (17 1/2")

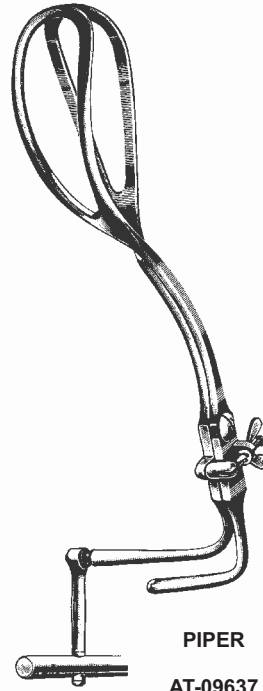

PIPER
AT-09637
400mm (16")

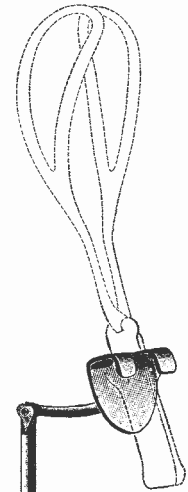

BILL
AT-09640

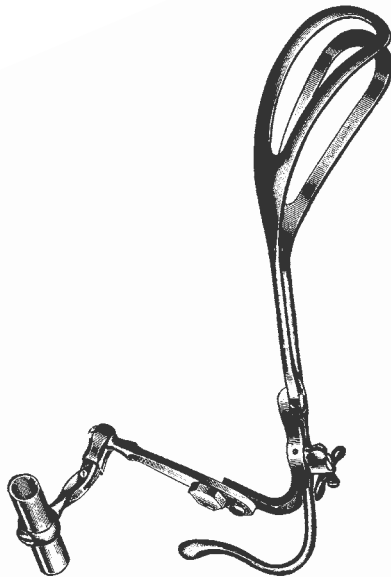

DEWEY
AT-09638
370mm (14 3/4")

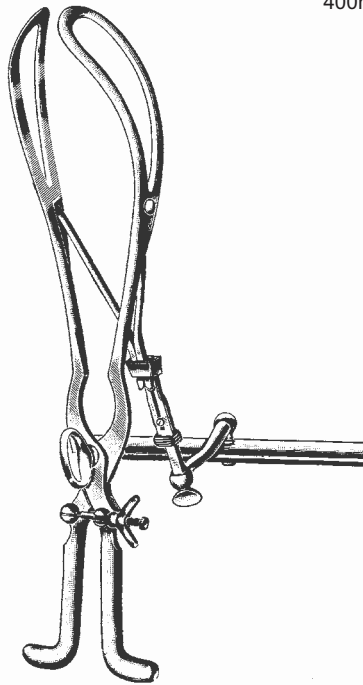

TARNIER
AT-09639
400mm (16")

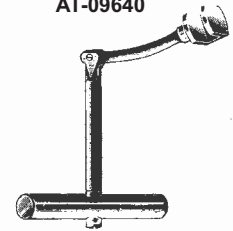

LUIKART-BILL
AT-09641
210mm (8 1/4")

OBSTETRICS (MIDWIFERY) FORCEPS

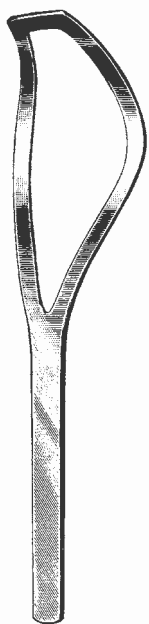

SELLHEIM
AT-09642
280mm (11")

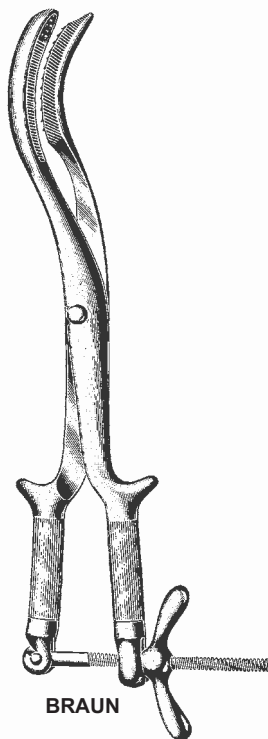

BRAUN
AT-09643
420mm (16 3/4")

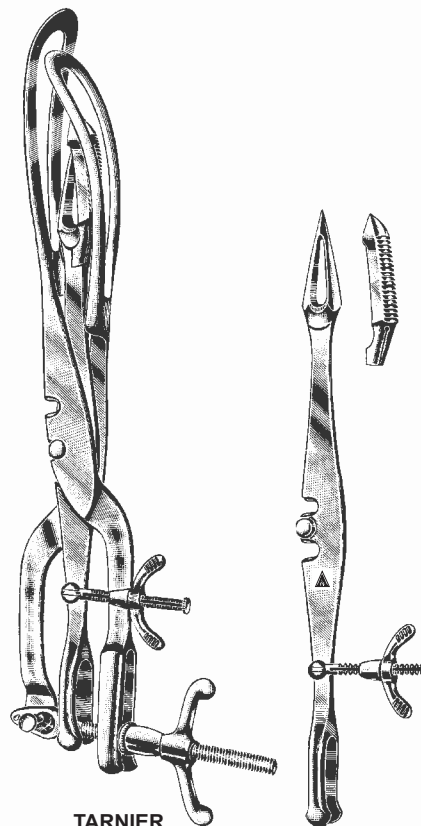

TARNIER
AT-09644
460(18 1/4")

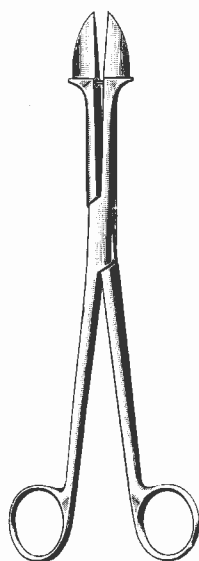

SPELLIE
AT-09645
250mm (10")

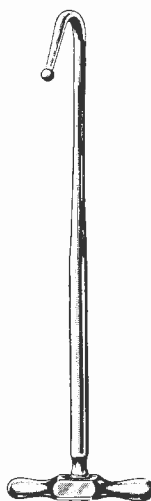

BRAUN
AT-09646
300mm (12")



DERMATOLOGY INSTRUMENTS



KILNER
AT-09647
150mm (6")



SCHAMBERG
AT-09648
100mm (4")



UNNA
AT-09649
140mm (5 1/2")



UNNA
AT-09650
140mm (5 1/2")

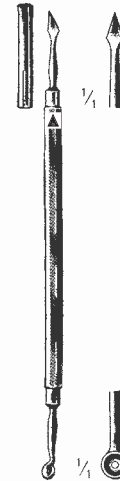

WALTON
AT-09651
140mm (5 1/2")



SAALFELD
AT-09652
100mm (4")

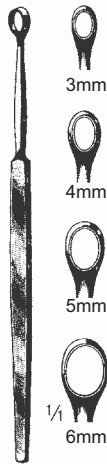

FOX
AT-09653

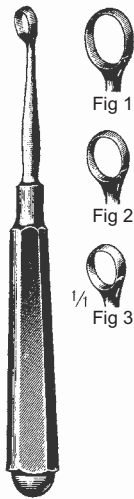

PIFFARD
AT-09654

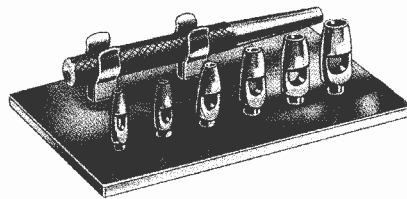

KEYES
AT-09655
Complete

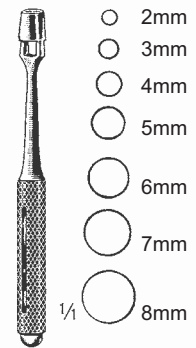

KEYES
AT-09656

DERMATOLOGY INSTRUMENTS



**GREEN - ARMYTAGE
HEAMOSTASIS FORCEPS**

AT-09657
200mm (8") Straight

AT-09658
195mm (73/4") Angled

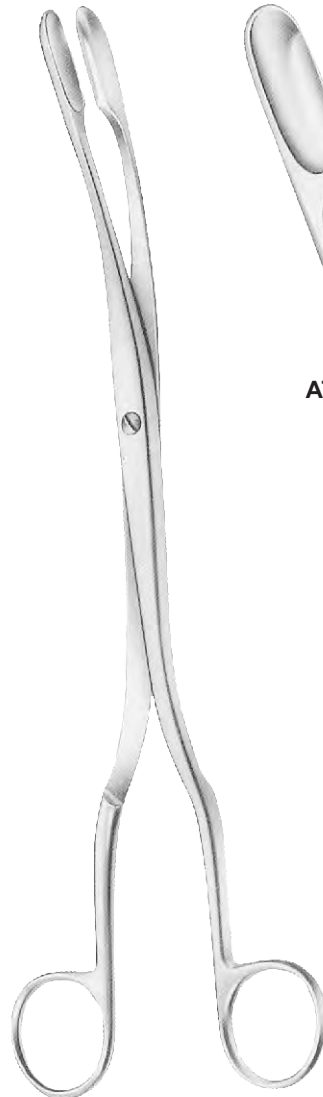

WINTER OVUM FORCEPS
290mm (111/2")



AT-09659

AT-09660

AT-09661



GYNECOLOGY INSTRUMENTS

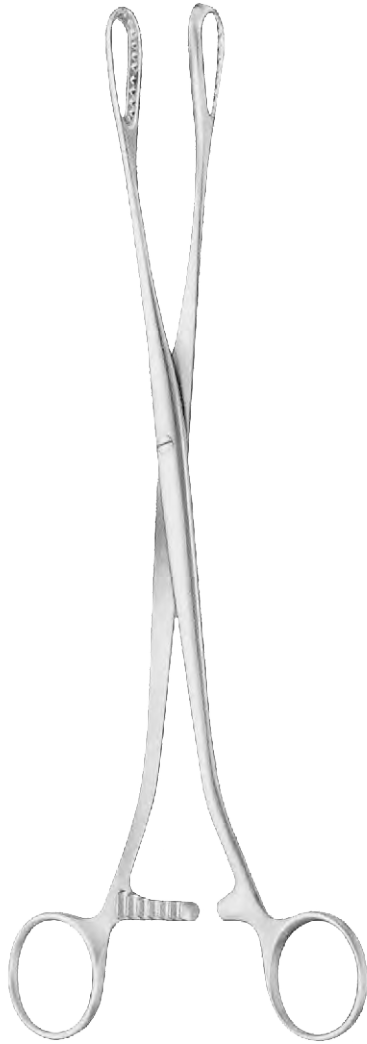

SAENGER OVUM FORCEPS

AT-09662
275mm (10 3/4")



UMBILICAL DILATOR

AT-09663
95mm (3 3/4")

PERITONEUM INSTRUMENTS



AT-09664



AT-09665



AT-09666



AT-09667



AT-09668



AT-09669



MIKULICZ
AT-09664
180mm (7")

AT-09665
205mm (8")



PEROTONEUM
AT-09666
205mm (8")

AT-09667
205mm (8")



FAURE
AT-09668
205mm (8")

AT-09669
205mm (8")



HYSTERECTOMY CLAMPS



AT-09670



AT-09671



AT-09672



AT-09673



AT-09674



**GWILLIAM
HYSTERECTOMY**
200mm (8")

AT-09670
Straight

AT-09671
Curved



**HEANY
HYSTERECTOMY FORCEPS**
200m (8")

AT-09672
Curved, single tooth



HEANY
AT-09673
205mm (8")

AT-09674
245cm (93/4")

INSTRUMENTS

HYSTERECTOMY CLAMPS



**MAINGOT
GYSTERECTOMY FORCEPS**

AT-09675
200mm (8")
Curved, 1 x 2 teeth

AT-09676
Straight, 1 x 2 teeth

AT-09677
240mm (9 1/2")
Curved, 1 x 2 teeth



PHANEUF

AT-09678
205mm (8")
Straight, 1 x 2 teeth



BONNEY

AT-09679
205mm (8")
Angled on flat, 1 x 2 teeth



HYSTERECTOMY CLAMPS

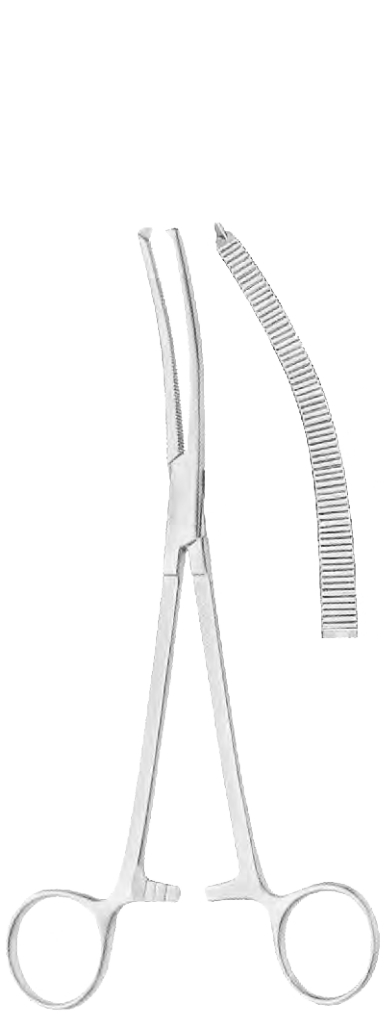

**BONNEY - BERKELEY
HYSTERECTOMY FORCEPS**

AT-09680
190mm (7 1/2")
Curved on flat, 1 x 2 teeth



WERTHEIM

AT-09681
235mm (9 1/4")



WERTHEIM

AT-09682
245mm (9 3/4")

HYSTERECTOMY CLAMPS



AT-09683
215mm
(8 1/2")

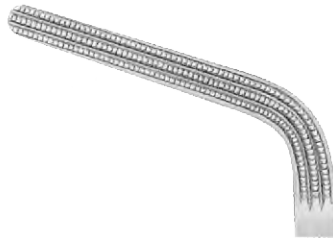

AT-09684
205mm
(8")



AT-09685
250mm
(10")



AT-09686
245mm
(9 3/4")

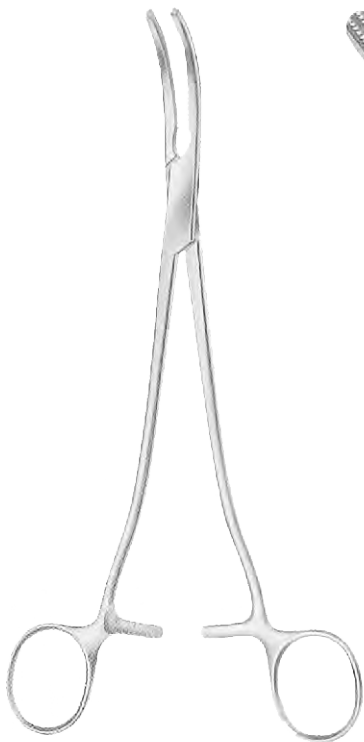

**HYSTERECTOMY
FORCEPS**
Atraumatic

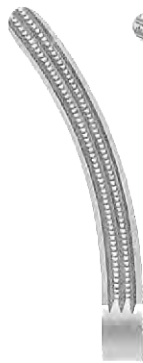

AT-09687
220mm
(8 3/4")



AT-09688
240mm
(9 1/2")



AT-09689
225mm
(9")



AT-09690
230mm
(9")



HYSTERECTOMY CLAMPS



WERTHEIM

AT-09691
255mm (10")

PROCTOLOGY



**GRAEME ANDERSON
RECTAL SPECULUM**

AS-09700
190mm (7 1/2")
Diameter: 19mm

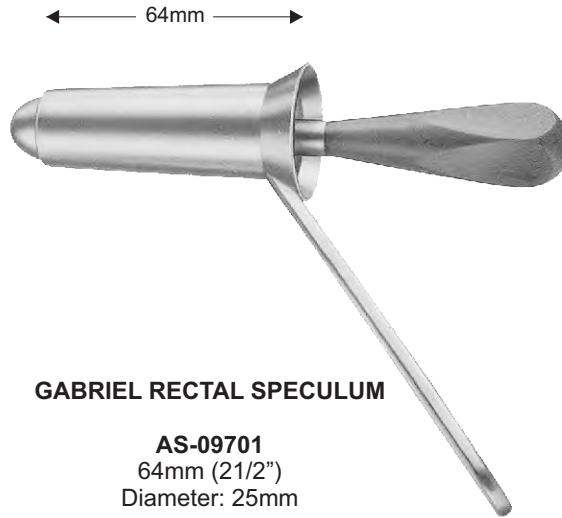

GABRIEL RECTAL SPECULUM

AS-09701
64mm (2 1/2")
Diameter: 25mm



KELLY PROCTOSCOPE

AS-09702
140mm (5 1/2") Diameter, 22mm



SIMS RECTAL SPECULUM

AS-09703
160mm (6 1/4")



PROCTOLOGY

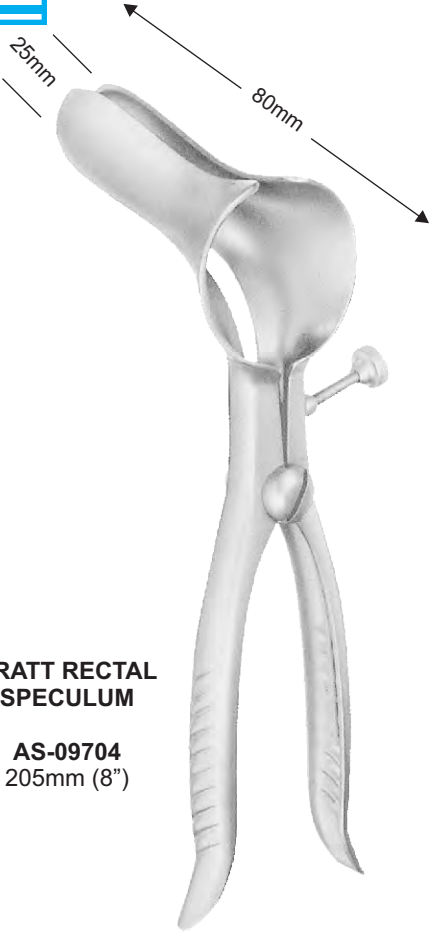

PRATT RECTAL SPECULUM
AS-09704
205mm (8")



CZERNY RECTAL SPECULUM
AS-09705
225mm (9")



MCEVEDY RECTAL SPECULUM WITH BATTERY HANDLE
AS-09706
150mm (6") Diameter: 27mm

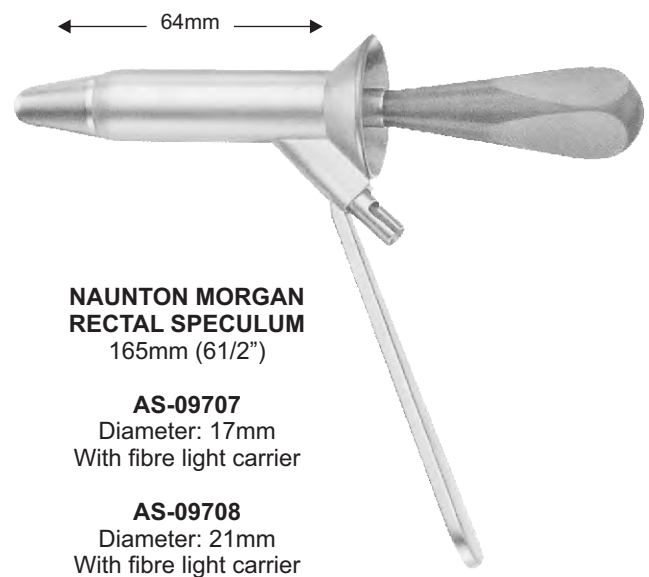

NAUNTON MORGAN RECTAL SPECULUM
165mm (6 1/2")
AS-09707
Diameter: 17mm
With fibre light carrier
AS-09708
Diameter: 21mm
With fibre light carrier
AS-09709
Diameter: 24mm
With fibre light carrier

INSTRUMENTS

SIGMOIDOSCOPY

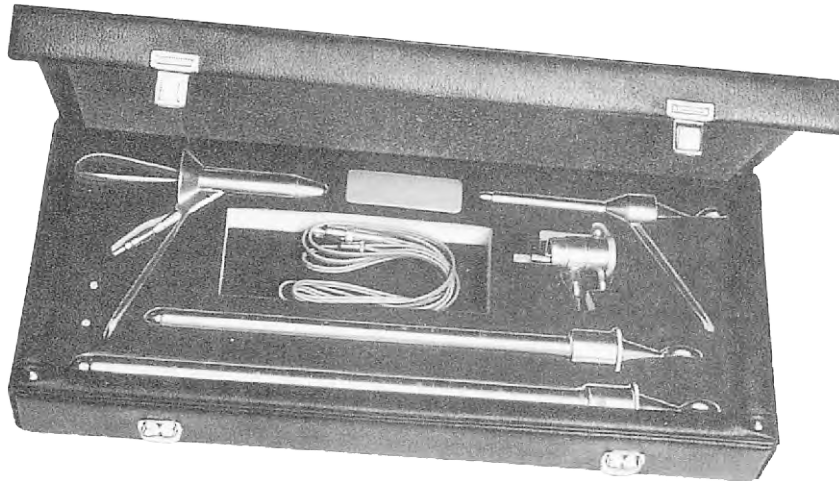

**LLOYD DAVIES (ST MARKS PATTERN)
MAJOR SIGMOIDOSCOPE AND
PROCTOSCOPE SET**

AS-09710

Set of consisting
Naunton Morgan Rectal Speculum (17mm)
Lloyd Davies Proctoscope (10mm)
Fibre light carrier
Lloyd Davies Sigmoidoscope (16mm)
Lloyd Davies Sigmoidoscope (20mm)
Case

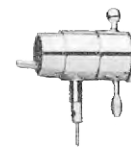

**LLOYD DAVIES (ST MARKS PATTERN)
COMBINATION SIGMOIDOSCOPE SET**

AS-09711

Consisting of
Fibre light carrier
Lloyd Davies Sigmoidoscope (16mm)
Lloyd Davies Sigmoidoscope (20mm)
Case



SIGMOIDOSCOPY

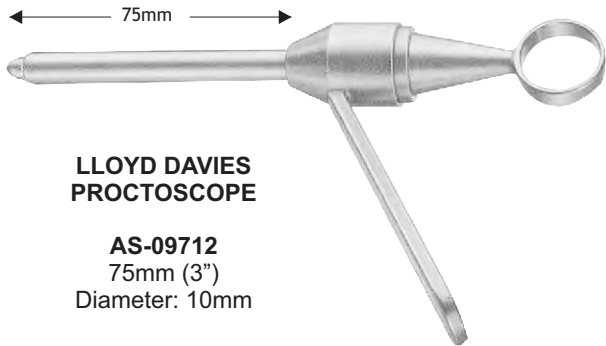

LLOYD DAVIES PROCTOSCOPE

AS-09712
75mm (3")
Diameter: 10mm

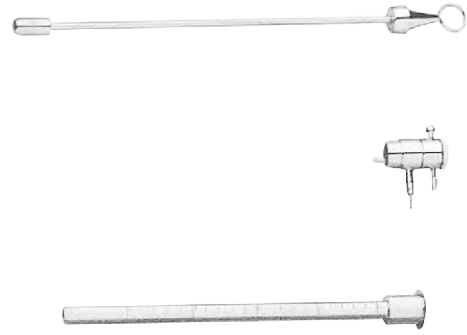

LLOYD DAVIES SIGMOIDOSCOPE

AS-09713
Set consisting of
Fibre light carrier
Lloyd Davies Sigmoidoscope (16mm)



AS-09714
250mm (93/4")
Diameter: 16mm
Sigmoidoscope only



AS-09715
300mm (113/4")
Diameter: 20mm
Sigmoidoscope only

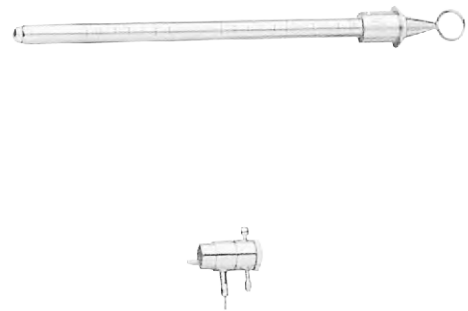

LLOYD DAVIES SIGMOIDOSCOPE

AS-09716
Set consisting of
Fibre light carrier
Lloyd Davies Sigmoidoscope (20mm)

SIGMOIDOSCOPY / BIOSPY

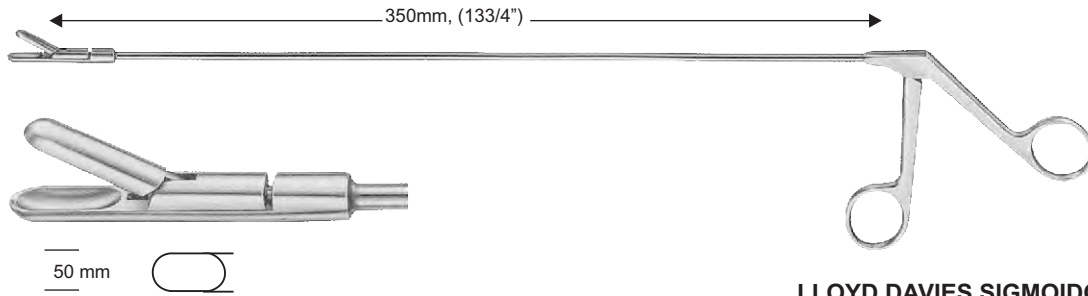

**LLOYD DAVIES SIGMOIDOSCOPE
BIOPSY FORCEPS**

AS-09717
350mm (133/4")

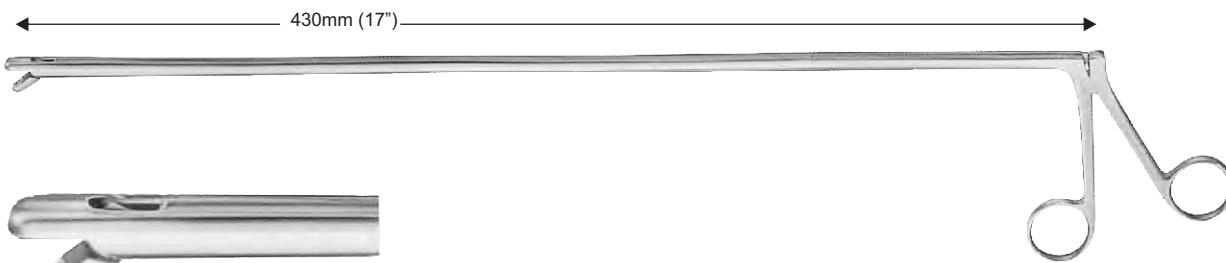

**OFFICER
BIOPSY FORCEPS**

AS-09718
430mm (17")
Jaws 8mm

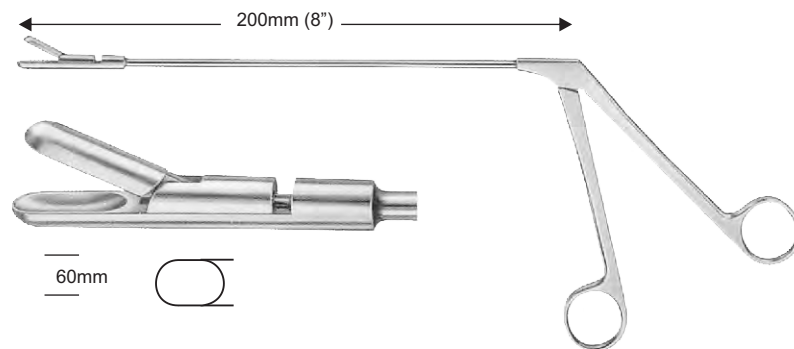

**WALTON RECTAL
BIOPSY FORCEPS**

AS-09719
200mm (8")
Laterally angled shanks



PROCTOLOGY HAEMORRHOIDAL IGATORS

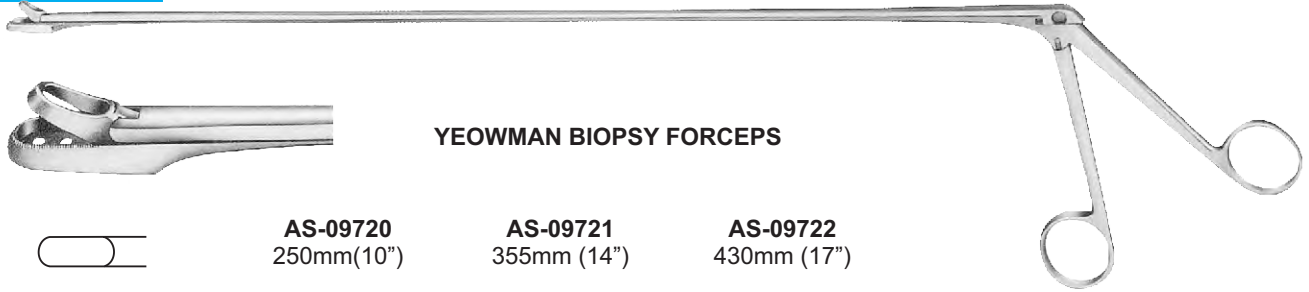

YEOWMAN BIOPSY FORCEPS



AS-09720
250mm(10")

AS-09721
355mm (14")

AS-09722
430mm (17")

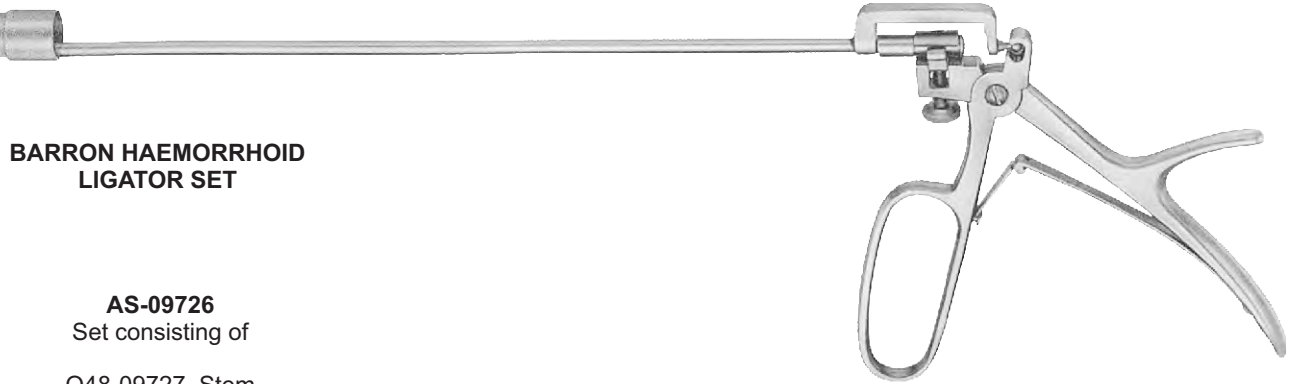

**BARRON HAEMORRHOID
LIGATOR SET**

AS-09726

Set consisting of

- O48-09727 Stem
- O48-09728 "O" Ring
- O48-09729 Conical loader for "O" Ring

O48-09730 universal Handle

AS-09727
215mm (8 1/2")
Stem Only

AS-09728
Pack of 300
"O" Rings

AS-09729
Conical loader only

AS-09730
Universal handle

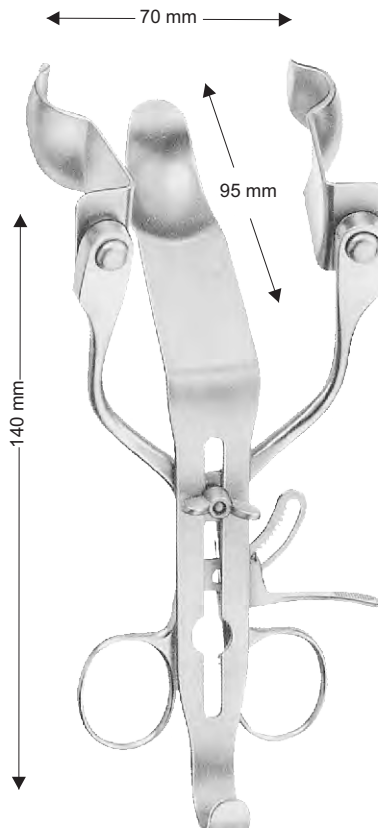

**PARK ANAL AND
SPHINCTERECTOMY
RETRACTOR**

AS-09723
Complete with:
Centre Blade: 95mm
Pair Blades: 70mm AS-09724
Pair Blades: 93mm AS-09725

AS-09724
Spare Blades 70mm

AS-09725
Spare Blades 93mm

HAEMORRHOIDAL LIGATORS



MCGIVNEY HAEMORRHOID LIGATOR SET

AS-09731
Set consisting of:

AS-09732 McGivney Ligator
AS-09728 "O" Rings
AS-09728 Conical loader for "O" rings

AS-09732
McGivney ligator stem
and handle only



ST GEORGES SEIZING FORCEPS

AS-09735
195mm (73/4")
To pass through applying drum
of Barron Ligator

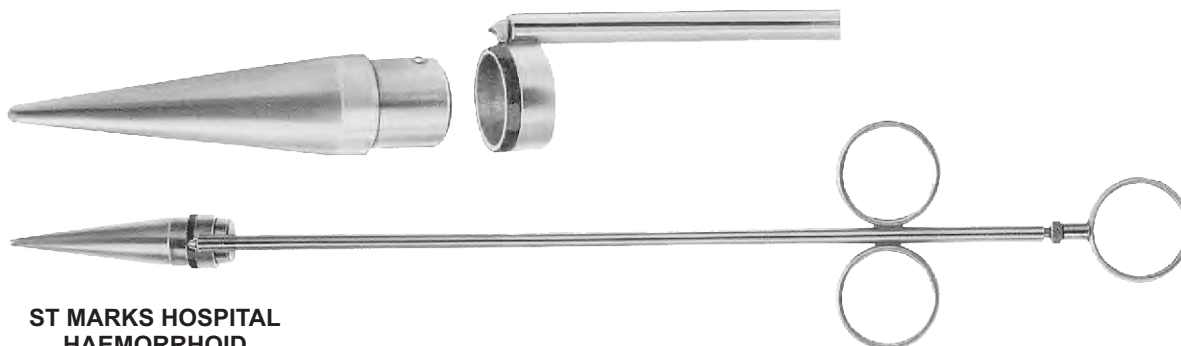

ST MARKS HOSPITAL HAEMORRHOID LIGATOR SET

AS-09733

Set consisting of
AS-09734 Ligator stem
AS-09728 "O" Rings
AS-09729 Conical loader for "O" rings

AS-09734
270mm (10 1/2")
Stem only



HAEMORRHOIDAL SYRINGES



GABRIEL METAL AND GLASS SYRINGE SET

Consisting of

- AS-09738 Gabriel needle, straight
- AS-09739 Gabriel needle, angled
- AS-09741 Gabriel syringe, 10ml



GABRIEL METAL AND GLASS SYRINGE SET

- AS-09737 Gabriel needle, straight
- AS-09738 Gabriel needle, straight
- AS-09739 Gabriel needle, angled
- AS-09740 Gabriel syringe, 3ml
- AS-09741 Gabriel syringe, 10ml



GABRIEL NEEDLES

Diameter: 09mm

AS-09737
75mm (3")
Straight

AS-09738
100mm (4")
straight

AS-09739
100mm (4")
Angled

GABRIEL SYRINGES

AS-09740
3ml

AS-09741
10ml

UROLOGY

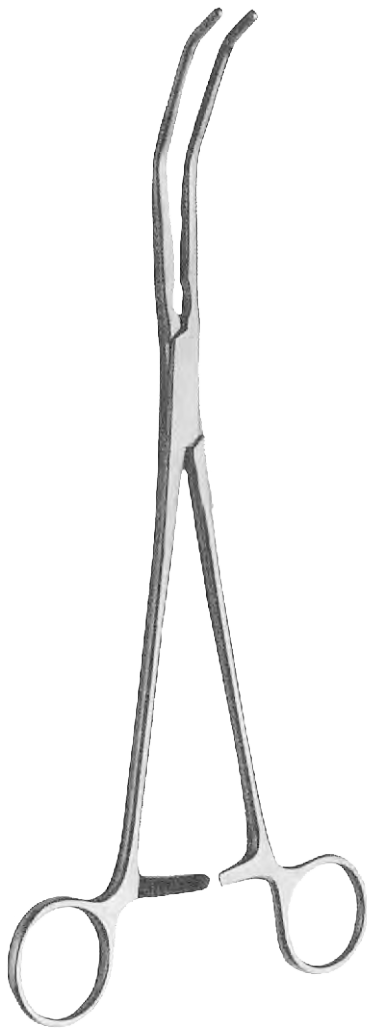

HERRICK
AR-09800
225mm (9")



GUYON
AR-09801
265mm (10 1/2")



KIDNEY CLAMP
AR-09802
255mm (10")

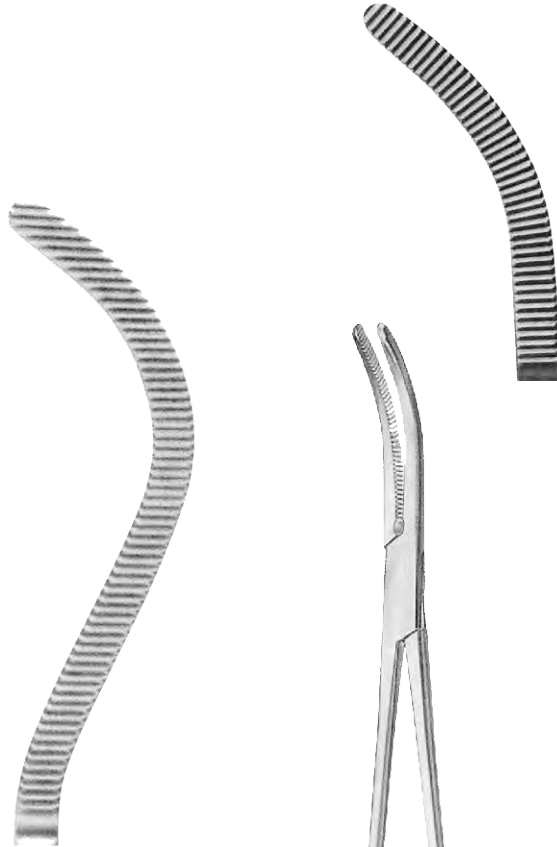



UROLOGY

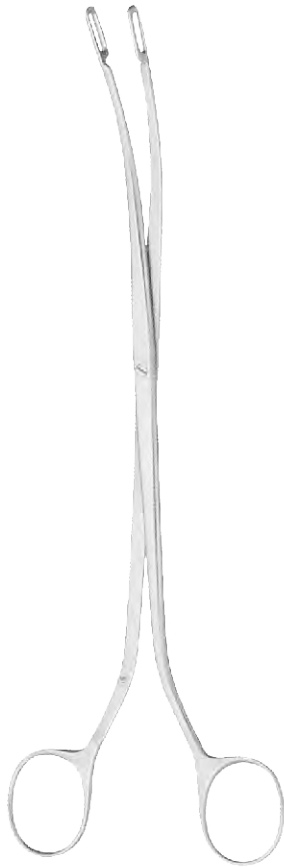

RANDALL
Renal Calculus Forceps

AR-09803
A
230mm (9")



AR-09804
B
200mm (8")



AR-09805
C
195mm (7 3/4")



AR-09806
D
180mm (7")

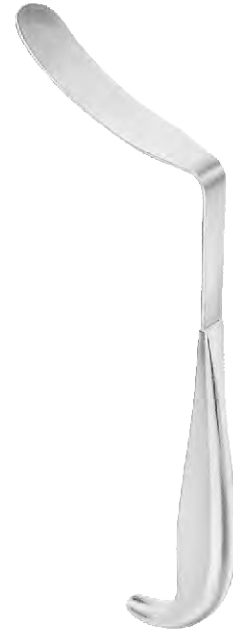

BLADDER SPATULA
AR-09807
235mm (9 3/4")
Blade: 91mm x 61mm



MILLIN
AR-09808
245mm (9 3/4")
Ligature holding forceps

UROLOGY



MILLIN
AR-09809
235mm (9 1/4")
Lobe grasping forceps



MILLIN
AR-09810
245mm (9 3/4")
Lobe grasping forceps



MILLIN
AR-09811
240mm (9 1/2")
Bladder neck spreader



**CUNNINGHAM
PENILE CLAMPS**
With foam rubber lining

AR-09812
Small

AR-09813
Medium

AR-09814
Large



**THOMPSON-WALKER
PENILE CLAMP**

AR-09815
115mm (4 1/2")



PENILE CLAMP

AR-09817
130mm (5 1/8")

MOULDED RUBBER SHEATHS

AR-09816
For use with AS-09815



UROLOGY

TURNER - WARWICK POSTERIOR DILATING URETHRAL SPECULUM

AR-09818

Black finish except for internal surfaces of blades, self retaining with fibre light carrier 225mm (8 3/4")

AR-09819

Retractor without fibre light carrier

AR-09820

Fibre light carrier only



AR-09821
30 degree No 1

AR-09822
70 degree No 2

AR-09823
90 degree No 3

TURNER-WARWICK POSTERIOR URETHRAL SUTURE NEEDLES

AR-09824

Set of three comprising of:
AR-09821 30 degree curve
AR-09822 70 degree curve
AR-09823 90 degree curve
200mm (8")
Black finish except for 8mm of tip

UROLOGY



AR-09826
Double ended
4/9 fg and 7/12 fg
133/3mm and 233/4mm



AR-09827
Double ended
10/15 fg and 13/18 fg
333/5mm and 433/6mm



AR-09828
Double ended
16/21 fg and 19/24 fg
533/7mm and 633/8mm



AR-09829
Double ended
22/27 fg and 25/30 fg
733/9mm and 833/10mm



AR-09830
Double ended
28/33 fg and 31/36 fg

**TURNER - WARWICK METAL
DILATORS
AR-09825**

Set of comprising of:

- 1 x O55-09826
- 1 x O55-09827
- 1 x O55-09828
- 1 x O55-09829
- 1 x O55-09830



UROLOGY



**TURNER WARWICK (HEY GROVES)
URETHRAL STAFF**

AR-09831
Black finish 180mm (7")



**TURNER WARWICK
DISSECTING SCISSORS**

Curved, with insulation shanks
and universal diathermy
attachment

AR-09832
145mm (53/4")

AR-09833
180mm (7")

AR-09834
230mm (9")



**TURNER WARWICK
NEEDLE HOLDER**

AR-09835
Straight, right hand model,
black finish 215mm (8 1/2")

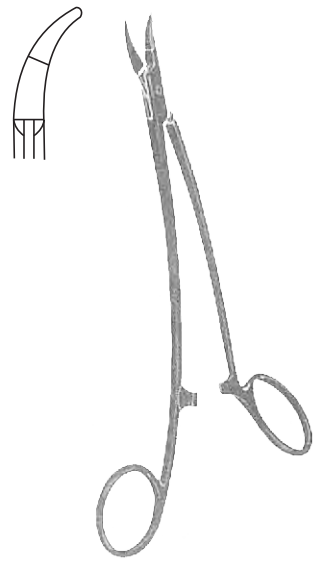

**TURNER WARWICK
NEEDLE HOLDER**

AR-09836
Curved, right hand model,
black finish 215mm (8 1/2")

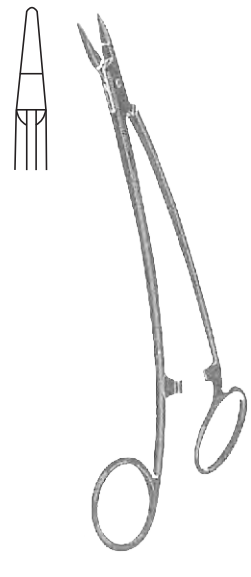

**TURNER WARWICK
NEEDLE HOLDER**

AR-09837
Straight, left hand model,
black finish 215mm (8 1/2")

INSTRUMENTS

UROLOGY



**TURNER WARWICK
NEEDLE HOLDER**

AR-09838
Curved, right hand model,
black finish 215mm (8 1/2")



**TURNER WARWICK
NEEDLE HOLDER**

AR-09839
Straight, wide jaws
black finish 215mm (8 1/2")



**TURNER WARWICK
POST URETHROPLASTY
REVIEW SPECULUM**

AR-09840
135mm (5 1/2")
Black finish except for internal surface
of blades, self retaining, fitted with
fibre light speculum

AR-09841
Speculum only without fibre light

AR-09842
Fibre light carrier only



UROLOGY

CLUTTON URETHRAL SOUNDS

265mm (10 1/2")

Set twelve **O58-09843**

Set Comprising one of each of:

- AR-09844** 6/10 fg (2/333mm)
- AR-09845** 8/12 fg (266/466mm)
- AR-09846** 10/14 fg (333/466mm)
- AR-09847** 12/16 fg (4/533mm)
- AR-09848** 14/18 fg (466/6mm)
- AR-09849** 16/20 fg (533/666mm)
- AR-09850** 18/22 fg (6/733mm)
- AR-09851** 20/24 fg (666/8mm)
- AR-09852** 22/26 fg (733/866mm)
- AR-09853** 24/28 fg (8/933mm)
- AR-09854** 26/30 fg (866/33mm)
- AR-09855** 28/32 fg (933/1066mm)

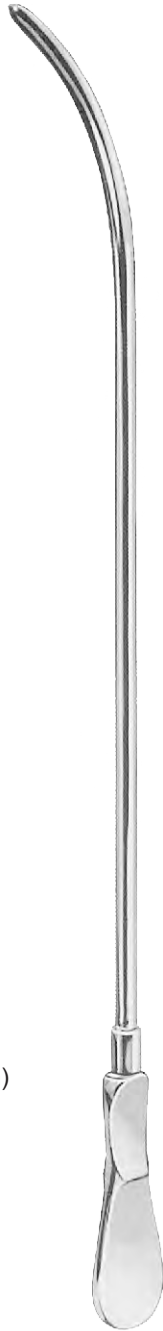

AR-09856
12 fg (4mm)

AR-09857
8 fg (266mm)

AR-09858
10 fg (333mm)

AR-09859
14 fg (466mm)

AR-09860
16 fg (533mm)



FEMALE CATHETERS
160mm (6 1/4")

SUCTION TUBES



POOLE

AI-09902
240mm (9 1/2")

AI-09903
180mm (7")
Lawrie extension piece



YANKAUER

AI-09900
305mm (12")

AI-09901
Rose end



AI-09904

GILLIES
170mm (6 3/4")
Control valve

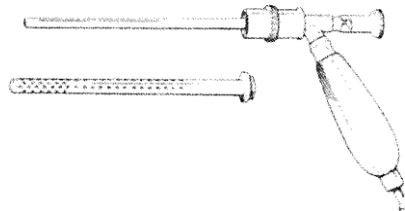

TINCKLER (SIMPSON SMITH)

AI-09905
255mm (10")
With on / off value, removable perforated outer sheath



SUCTION TUBES

FRAZIER

AI-09906

185mm (7 1/4") Diameter 233mm 7fg

AI-09907

185mm (7 1/4") Diameter 266mm 8 fg

AI-09908

185mm (7 1/4") Diameter 3mm 9fg



ADSON FRAZIER

180mm (7")

AI-09909 Diameter 2mm

AI-09910 Diameter 25mm

AI-09911 Diameter 3mm

AI-09912 Diameter 4mm

AI-09913 Diameter 5mm

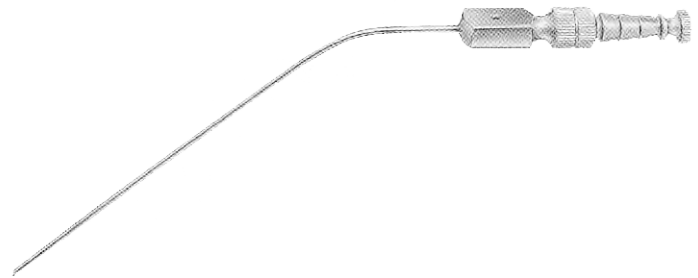

ADSON

180mm (7")

AI-09914 Diameter 3mm

AI-09915 Diameter 5mm



CONE SUCTION TUBES

AI-09916

Set comprising of one of each of the following items except AI-09920

SUCTION TUBES

AI-09917 Diameter: 3mm

AI-09918 Diameter: 4mm

AI-09919 Diameter: 5mm



HANDLE

AI-09920 100mm (4")
with Tucker valve



SUCTION TUBES



BARRON

AI-09921
230mm (9")
Diameter: 133mm



BELUCCI

AI-09922
Set comprising of each of the following items:

BELUCCI SUCTION TUBE

AI-09923
170mm (63/4") Diameter: 2mm



ZOELLNER DETACHABLE ENDS

AI-09924 20 swg
AI-09925 22 swg
AI-09926 24 swg

FORMBY
AI-09927
210mm (81/4")
Diameter: 33mm

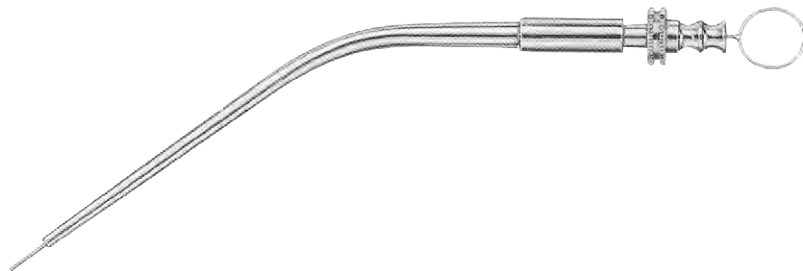

HOUSE

Shaft: 90mm (31/2")
Suction and irrigation tube

AI-09928
Diameter suction tube: 09mm
Diameter irrigating tube: 07mm

AI-09929
Diameter suction tube: 12mm
Diameter irrigating tube: 09mm

AI-09930
Diameter suction tube: 15mm
Diameter irrigating tube: 12mm

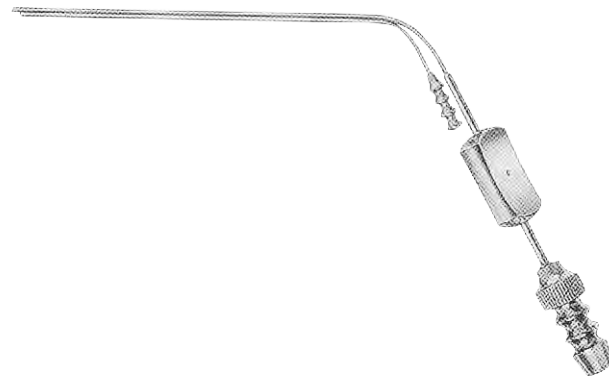



SUCTION TUBES

MAGILL
210mm (8 1/4")

AI-09931
Diameter: 3mm

AI-09932
Diameter: 35mm

AI-09933
Diameter: 4mm

AI-09934
Stilette



SELF CLEARING
230mm (9")

AI-09935
Diameter: 15mm

AI-09936
Diameter: 2mm

AI-09937
Diameter: 3mm



SCHUKNECHT
135mm (5 1/4")

AI-09938
20 swg

AI-09939
24 swg



VERHOEVEN

AI-09941

Set comprising of one of each of the following items except AS-09940:

VERHOEVEN SUCTION TUBES

100mm (4")

AI-09942 16 swg

AI-09943 18 swg

AI-09944 20 swg

AI-09945 22 swg

AI-09946 24 swg



HOUSE ADAPTOR

AI-09940

38mm (1 1/2")

For use with Verhoeven Suction Tubes

HOUSE ADAPTOR
38mm (1 1/2")

SUCTION TUBES



ZOELLNER

AI-09947
180mm (7")



ZOELLNER DETACHABLE ENDS

AI-09948
18 swg

AI-09949
20 swg

AI-09950
22 swg

AI-09951
24 swg

AI-09952
26 swg



ROWBOTHAM

AI-09953
285mm (11 1/4")



CHIP SYRINGE

AI-09954
For administering antibiotic powder



AI-09955
Abrahams Pleural biopsy punch
4mm diameter



AMPUTATION INSTRUMENTS



LISTON

AK-010000
Blade: 130mm (5 1/8")

AK-010001
Blade 220mm (8 3/4")



LANGENBECK

AK-010002
Resection knife

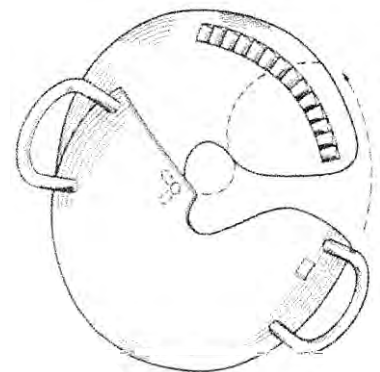

**BLAKE AMUPTATION FLAP
RETRACTOR**

AK-010003
Diameter: 240mm (9 1/2")

AMPUTATION INSTRUMENTS

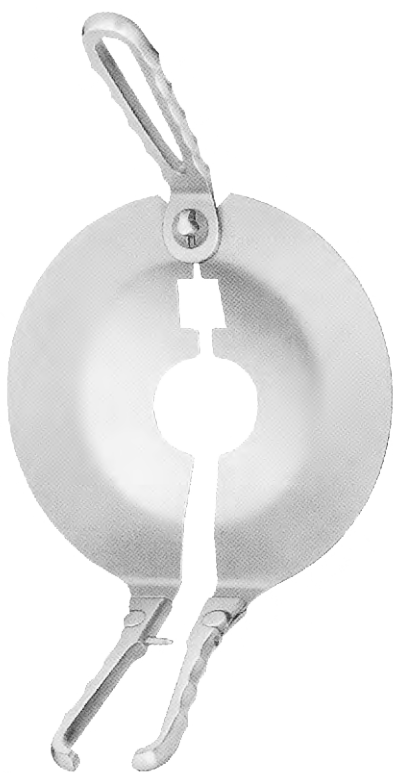

PERCY AMPUTATION FLAP RETRACTOR

AK-010004

Removable handles



AMPUTATION SAW

With hinged back to take apart

AK-010005

Blade: 230mm (9")

AK-010006

Spare blade for amputation saw



FINGER SAW

AK-010007

200mm (8")



ARMY REGULATION AMPUTATION SAW

AK-010008

Blade: 180mm (7")

With hinged back to take apart



BONE LEVERS & ELEVATORS



ST THOMAS



AK-011000
180mm (7")
Pointed end

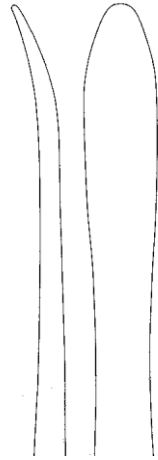

AK-011001
180mm (7")
Rounded end



CAIRNS SKULL FLAP ELEVATOR

AK-011002
180mm (7")



TRETOWAN BONE LEVER

AK-011003
215mm (8 1/2")

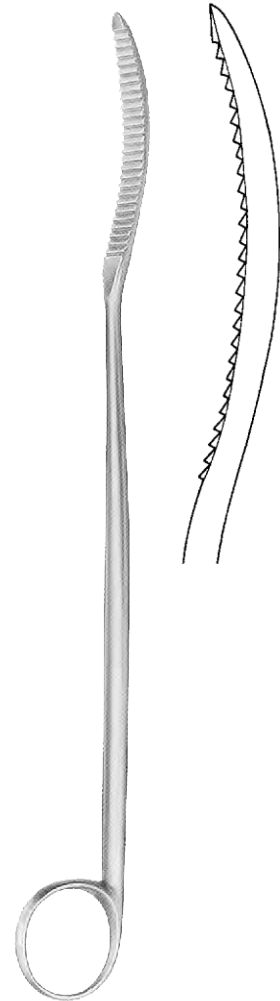

LANE BONE LEVER

AK-011004
255mm (10")

BONE LEVERS



**WATSON JONES
BONE LEVER**

AK-011005
280mm (11")



AK-011006

AK-011006
265mm (10 1/2")

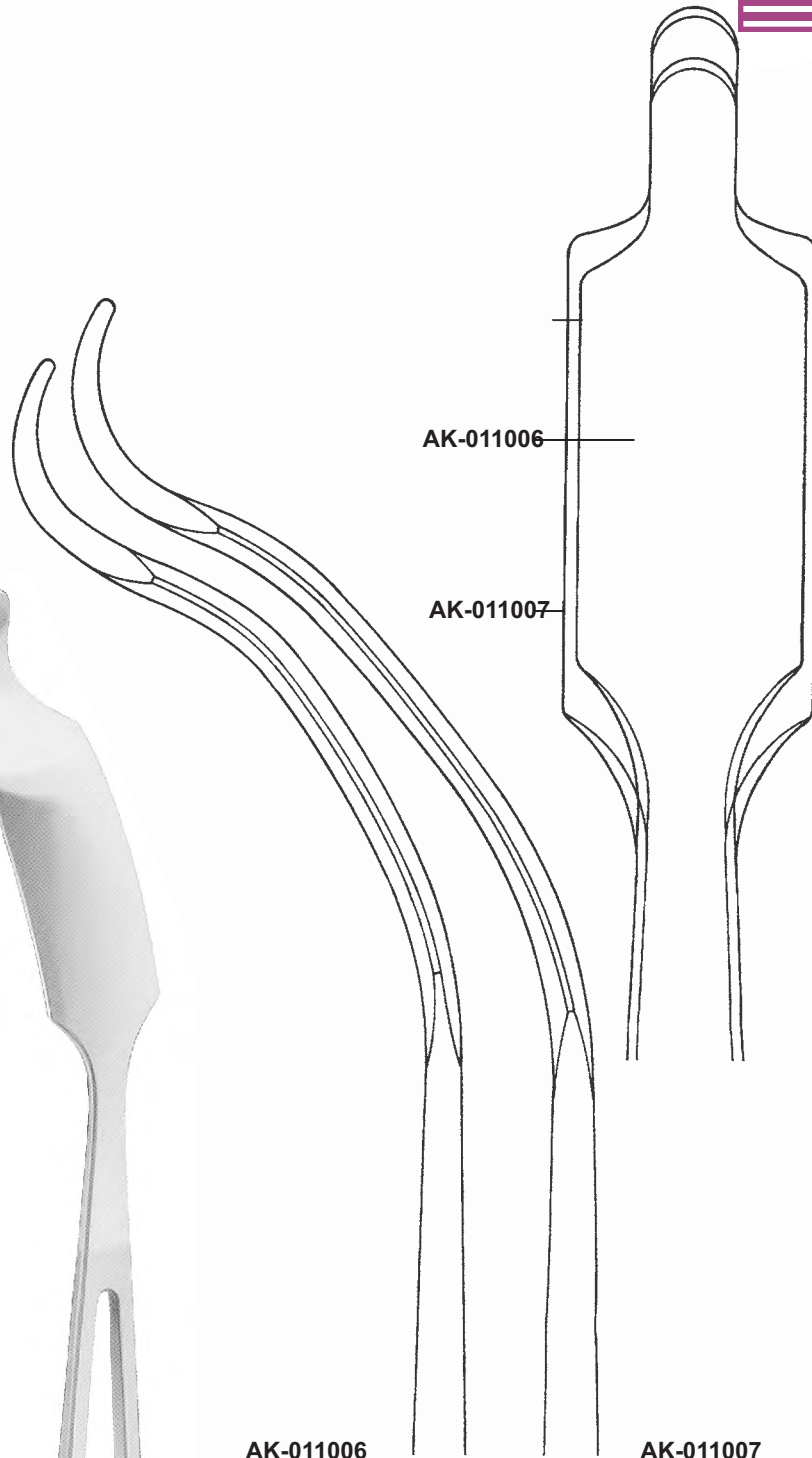

AK-011006

AK-011007

AK-011007

AK-011007
280mm (11 1/2")



BONE LEVERS

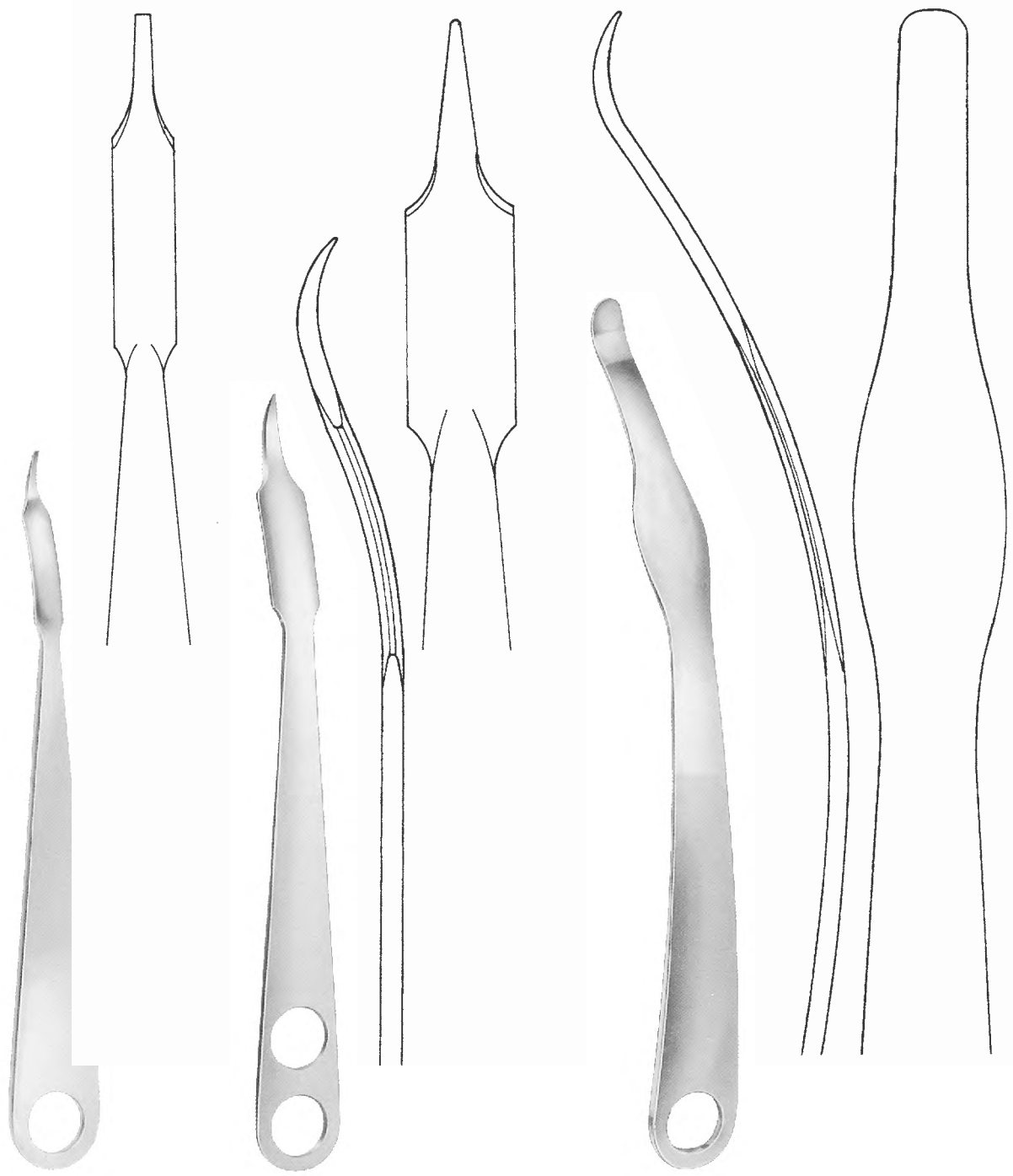

HOHMANN

AK-011008
220mm (83/4")
Max width: 10mm

HOHMANN

AK-011009
240mm (91/2")
Max width: 17mm

HOHMANN

AK-011010
260mm (101/4")
Max width: 25mm

BONE LEVERS

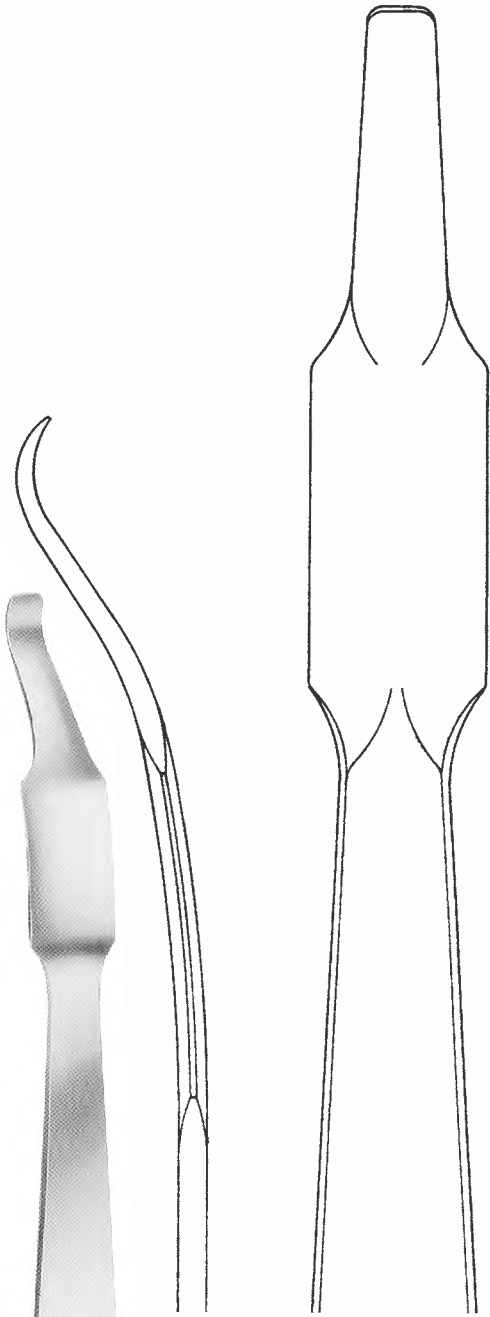

HOHMANN
AK-011011
260mm (10 1/4")
Max width: 24mm

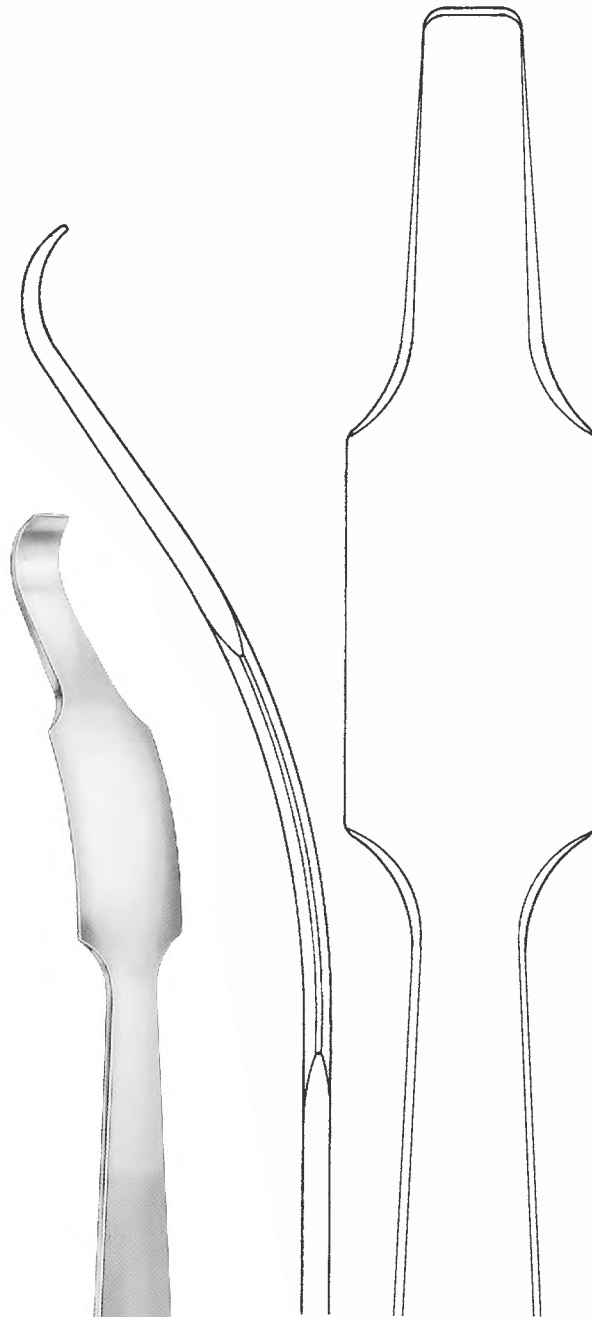

HOHMANN
AK-011012
285mm (11 1/4")
Max width: 34mm



BONE LEVERS

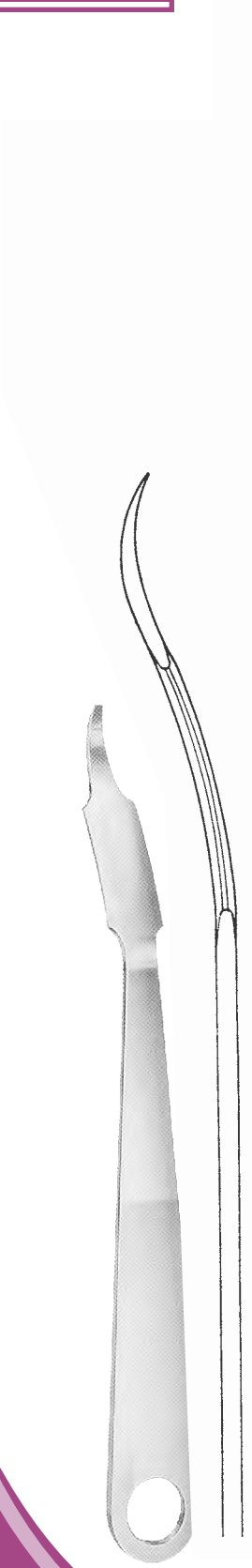

**HOHMANN
SPIKE RETRACTOR**

AK-011013
240mm (9 1/2")
Width: 17mm

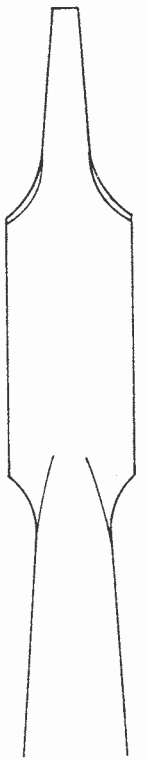

**HOHMANN
SPIKE RETRACTOR**

AK-011014
240mm (9 1/2")
Width: 44mm

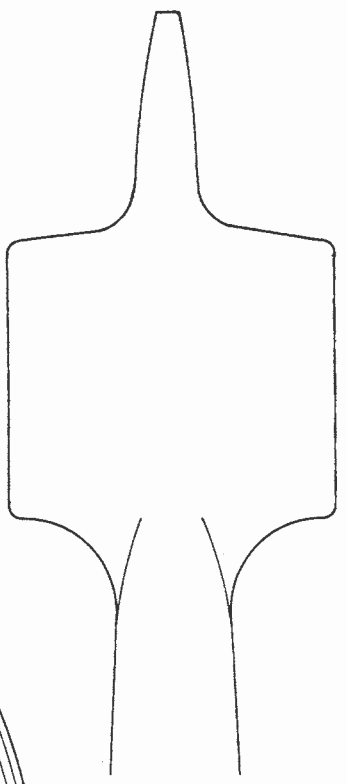

BONE LEVERS



**"COBRA"
HIP LEVER**

AK-011015
235mm (9 1/4")
Max Width: 65mm
Width at tip: 25mm

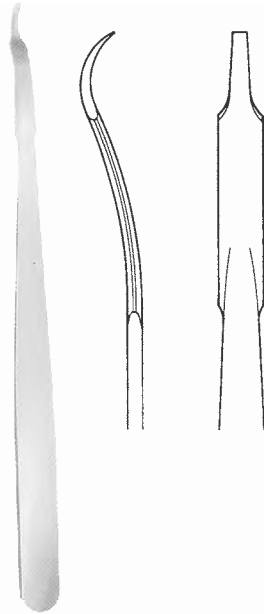

MINI-HOHMANN

AK-011016
160mm (6 1/4")
Max width: 6mm
Width at tip: 2mm

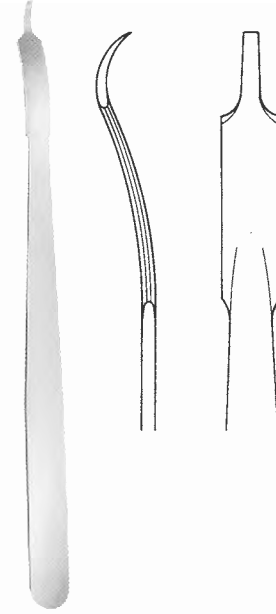

MINI-HOHMANN

AK-011017
160mm (6 1/4")
Max width: 8mm
Width at tip: 2mm

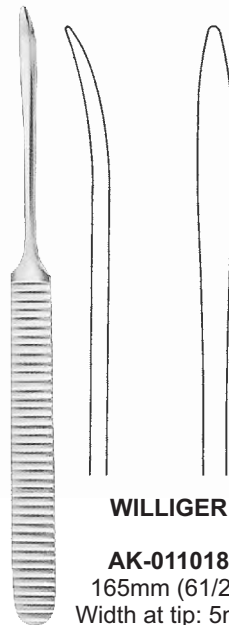

WILLIGER

AK-011018
165mm (6 1/2")
Width at tip: 5mm

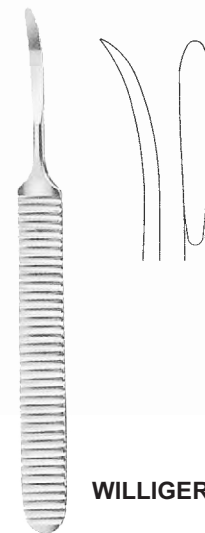

WILLIGER

AK-011019
140mm (4 1/2")
Width at tip: 4mm



BONE LEVERS & RASPATORIES

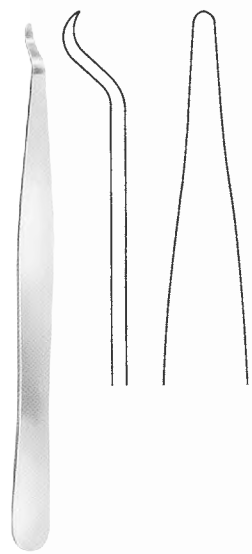

AK-011020
140mm (5 1/2")
Width at tip 28mm

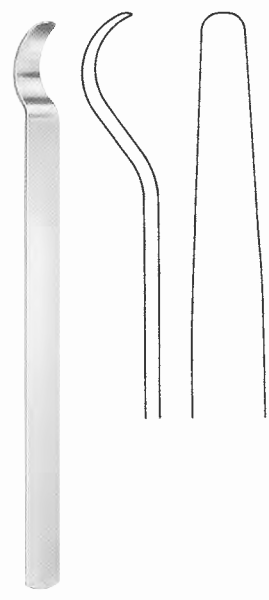

AK-011021
150mm (6")
Width at tip 6mm

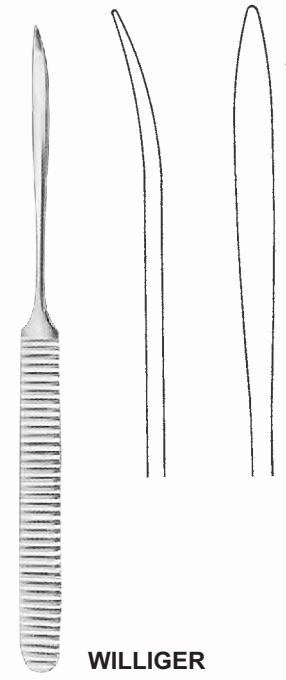

WILLIGER
AK-011022
175mm (7")
Width at tip 55mm

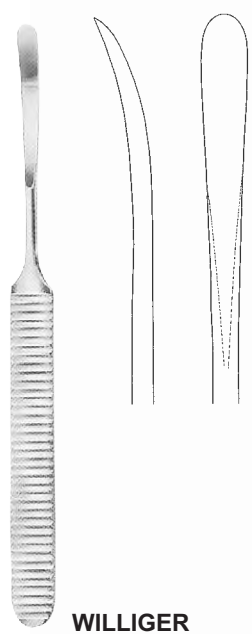

WILLIGER
AK-011023
160mm (6 1/4")
Width at tip 65 mm

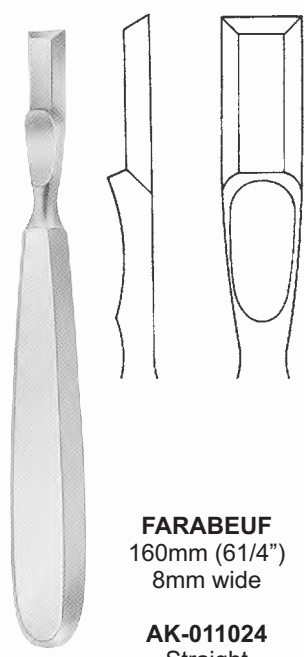

FARABEUF
160mm (6 1/4")
8mm wide
AK-011024
Straight
AK-011025
Curved



HOWARTH
AK-011026
230mm (9")



RASPATORIES

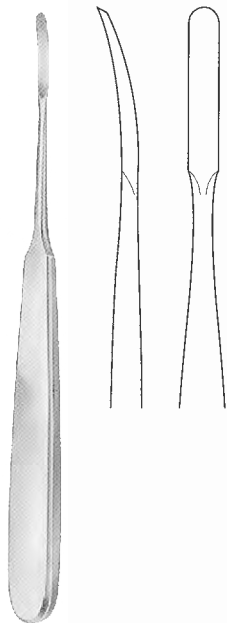

JOSEPH

AK-011027
170mm (63/4")
Width at tip: 4mm

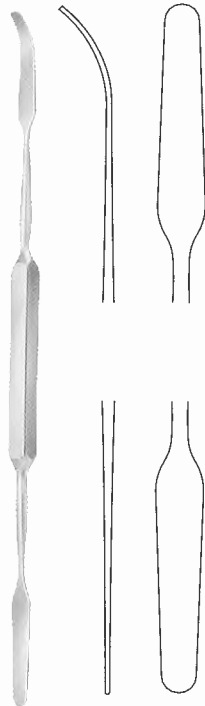

MACDONALD

AK-011028
185mm (71/4") blunt

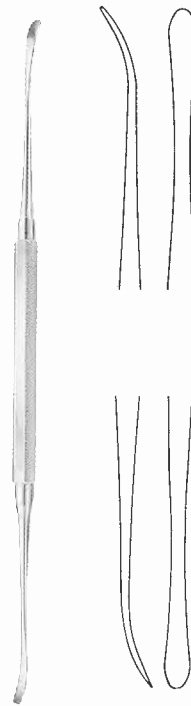

FREER ELEVATOR

AK-011029
190mm (71/2"), double ended



ADSON

165mm (61/2"), curved
AK-011030 width 5mm
AK-011031 width 7mm



ADSON

165mm (61/2") slight curve
AK-011032 Width 7mm



PENNYBACKER

150mm (6")
AK-011033 Width 6mm





RASPATORIES

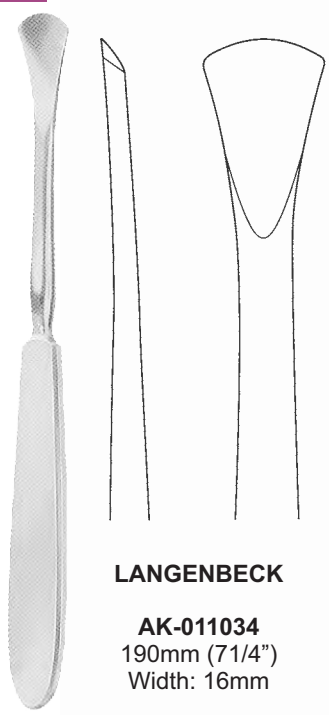

LANGENBECK
AK-011034
190mm (7 1/4")
Width: 16mm



MCKISSOCK
AK-011035
195mm (7 3/4")

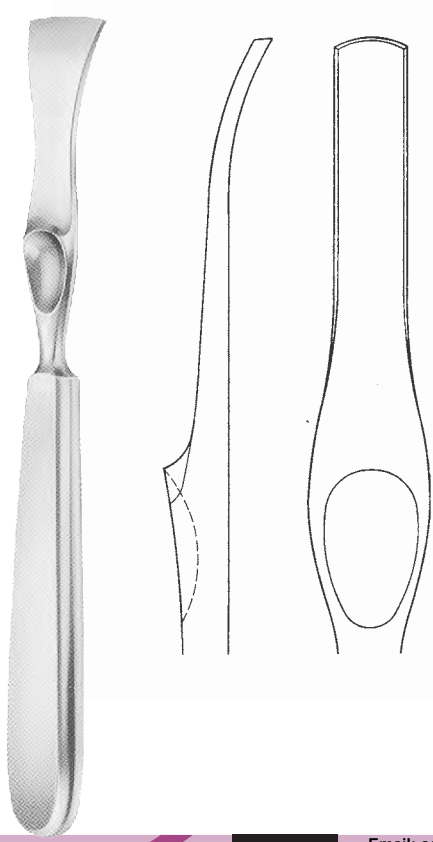

LAMBOTE
215mm (8 1/2")
AK-011036
Width: 5mm
AK-011037
Width: 10mm
AK-011038
Width: 15mm
AK-011039
Width: 20mm
AK-011040
Width: 25mm

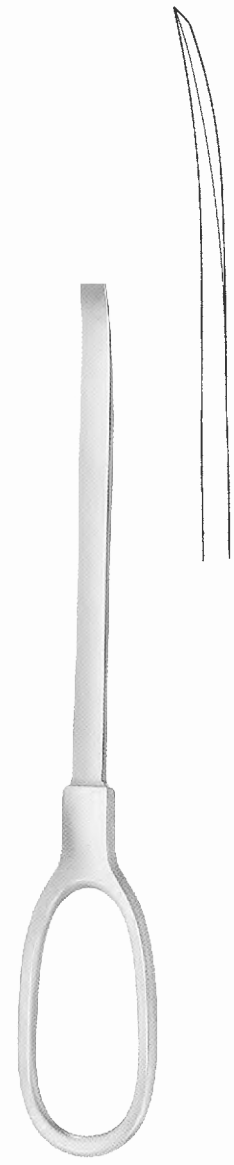

BRISTOW
AK-011041
230mm (9")

INSTRUMENTS



RASPATORIES

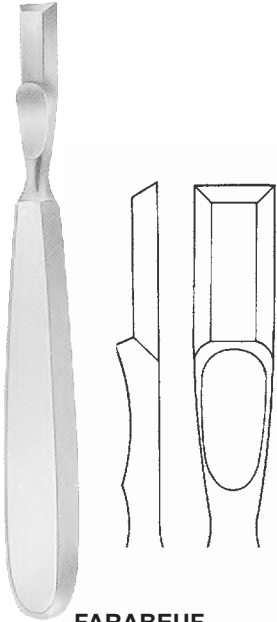

FARABEUF

AK-011042
160mm (6 1/2")
Straight

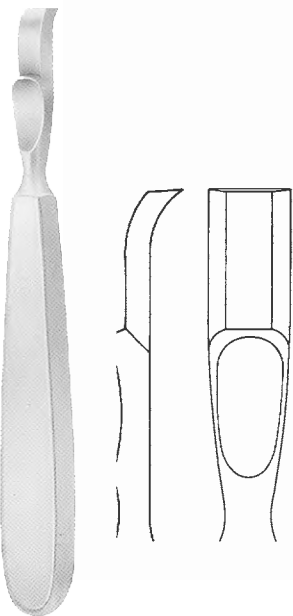

FARABEUF

AK-011043
160mm (6 1/2")
Curved



MITCHELL

AK-011044
210mm (8 1/4")
Straight edge



JONES

AK-011045
185mm (7 1/4")
Convex edge

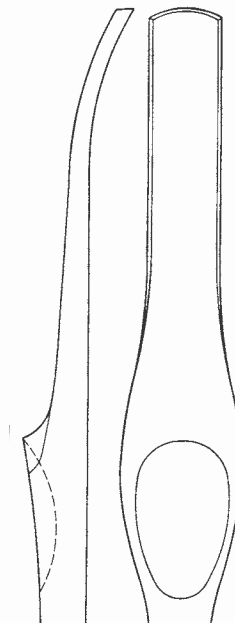



RASPATORIES



BONE FILE AND RASP

AK-011046
220mm (83/4")



AK-011047
240mm (9 1/2")

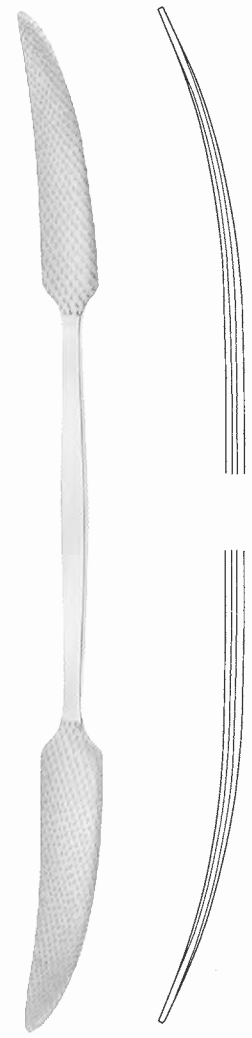

PUTTI RASP

AK-011048
270mm (10 3/4")
Width: 18mm and 20mm



RASPATORIES



VOLKMANN
170mm (63/4")

28mm	36mm	44mm	52mm	68mm
AK-011049	AK-011050	AK-011051	AK-011052	AK-011053
85mm	10mm	115mm	13mm	145mm
AK-011054	AK-011055	AK-011056	AK-011057	AK-011058

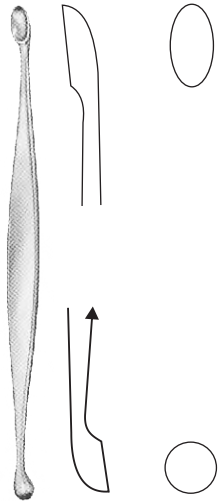

BOYD BONE CURETTE
Oval, double ended
AK-011059
130mm (51/8")

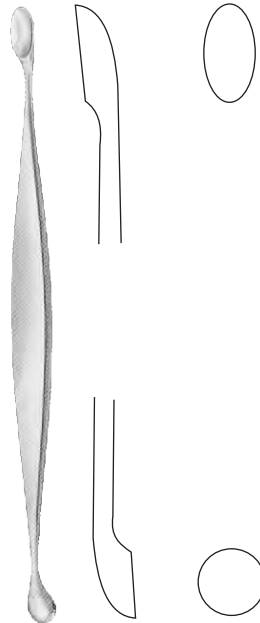

BOYD BONE CURETTE
Oval, double ended
AK-011060
160mm (61/4")

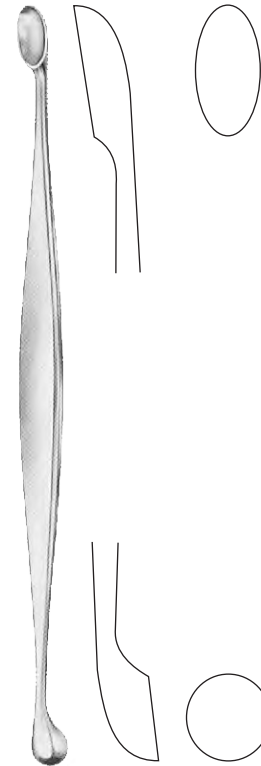

BOYD BONE CURETTE
Oval, double ended
AK-011061
200mm (8")



BONE SCOOPS



VOLKMANN
Double ended

AK-011062
130mm (51/8")

AK-011063
140mm (51/2")

AK-011064
170mm (63/4")



MACEWEN
180mm (7")
Combined with seeker

AK-011065
Oval

AK-011066
Round

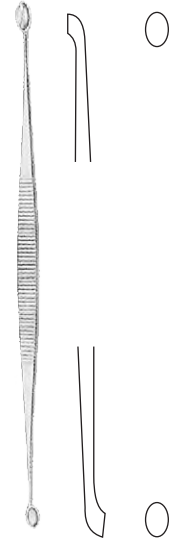

JACOBSON

AK-011067
140mm (51/2")

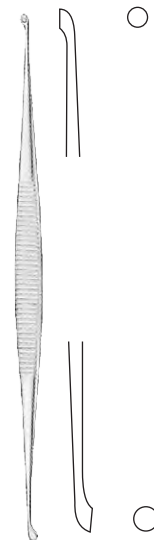

MARTINI

AK-011068
140mm (51/2")

BONE SCOOPS



MARTINI
AK-011069
140mm (5 1/2")



LEMPERT
200mm (8")*

AK-011070
2mm x 35mm

AK-011071
2mm x 4mm

AK-011072
25mm x 45mm

AK-011073
275mm x 5mm

AK-011074
3mm x 55mm

AK-011075
325mm x 6mm



COLLIER AND MORRIS
180mm (7")

AK-011076
2mm x 3mm

AK-011077
3mm x 4mm

AK-011078
4mm x 5mm

AK-011079
5mm x 6mm



OSTEOTOMES, CHISELS & GOUGES



SWEDISH MODEL CHISELS
200mm (8")
Straight

AK-012000
Width: 10mm

AK-012001
Width: 15mm

AK-012002
Width: 20mm

AK-012003
Width: 25mm

AK-012004
Width: 30mm

CAPENER CHISELS
255mm (10")
With Tufnal Handle
Straight

AK-012005
Width: 6mm

AK-012006
Width: 8mm

AK-012007
Width: 10mm

AK-012008
Width: 12mm

AK-012009
Width: 15mm

AK-012010
Width: 20mm

AK-012011
Width: 25mm

AK-012012
Width: 30mm

CAPENER CHISELS
255mm (10")
With Tufnal Handle
Curved

AK-012013
Width: 6mm

AK-012014
Width: 8mm

AK-012015
Width: 10mm

AK-012016
Width: 12mm

AK-012017
Width: 15mm

AK-012018
Width: 20mm

AK-012019
Width: 25mm

AK-012020
Width: 30mm

SWEDISH MODEL OSTEOTOME
200mm (8")
Straight

AK-012021
Width: 10mm

AK-012022
Width: 15mm

AK-012023
Width: 20mm

AK-012024
Width: 25mm

AK-012025
Width: 30mm

SMITH-PETERSON OSTEOTOME
200mm (8")
Straight

AK-012026
Width: 10mm

AK-012027
Width: 15mm

AK-012028
Width: 20mm

AK-012029
Width: 25mm

AK-012030
Width: 30mm

OSTEOTOMES, CHISELS & GOUGES

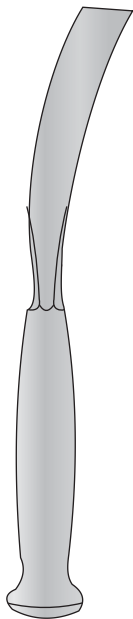

**SMITH-PETERSON
OSTEOTOME**
200mm (8")
Curved

AK-012031
Width: 10mm

AK-012032
Width: 15mm

AK-012033
Width: 20mm

AK-012034
Width: 25mm

AK-012035
Width: 30mm



CAPENER OSTEOTOME
255mm (10")
With Tufnal Handle
Straight

AK-012036
Width: 10mm

AK-012037
Width: 12mm

AK-012038
Width: 15mm

AK-012039
Width: 20mm

AK-012040
Width: 25mm

AK-012041
Width: 30mm



**LAMBOTTE
OSTEOTOME**
245mm (93/4")
Straight

AK-012042
Width: 4mm

AK-012043
Width: 8mm

AK-012044
Width: 10mm

AK-012045
Width: 13mm

AK-012046
Width: 15mm

AK-012047
Width: 18mm

AK-012048
Width: 20mm

AK-012049
Width: 25mm

AK-012050
Width: 30mm

AK-012051
Width: 38mm

AK-012052
Width: 44mm

AK-012053
Width: 50mm



CAPENER OSTEOTOME
255mm (10")
With Tufnal Handle
Curved

AK-012054
Width: 10mm

AK-012055
Width: 12mm

AK-012056
Width: 15mm

AK-012057
Width: 20mm

AK-012058
Width: 25mm

AK-012059
Width: 30mm



OSTEOTOMES, CHISELS & GOUGES



**HIBBS
OSTEOTOME**
200mm (8")
Straight

AK-012060
Width: 12mm

AK-012061
Width: 15mm

AK-012062
Width: 20mm

AK-012063
Width: 25mm

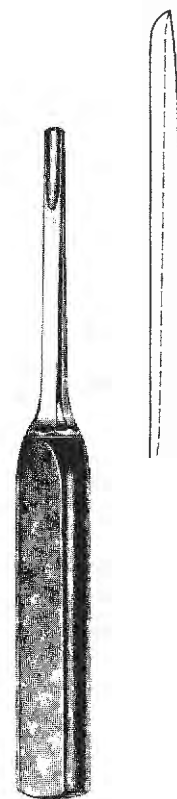

GOUGES
230mm (9")
With Tufnal Handle
Straight

AK-012064
Width: 10mm

AK-012065
Width: 15mm

AK-012066
Width: 20mm

AK-012067
Width: 25mm

OSTEOTOMES, CHISELS & GOUGES

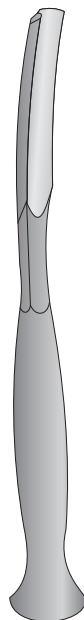
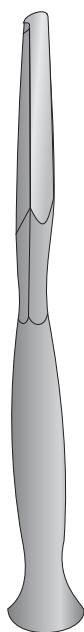

**SMITH-PETERSEN
GOUGES**
200mm (8")
Straight

AK-012068
Width: 10mm

AK-012069
Width: 15mm

AK-012070
Width: 20mm

AK-012071
Width: 25mm

**SMITH-PETERSEN
GOUGES**
200mm (8")
Concave

AK-012072
Width: 10mm

AK-012073
Width: 15mm

AK-012074
Width: 20mm

AK-012075
Width: 25mm



MALLETS

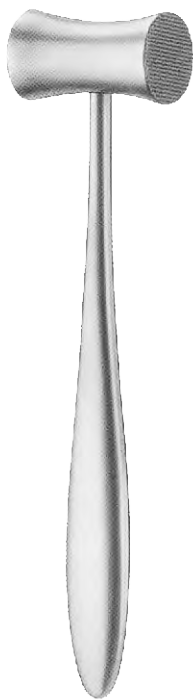

LUCAE

AK-013000
Diameter" 27mm
8 1/2 oz



KELSEY FRY

AK-013001
190mm (7 1/2")
Diameter: 20mm

SPARE DISKS

AK-013002
Spare disks for
Kelsey-Fry Mallet



HEATH

AK-013003
Diameter: 25mm
28 oz

AK-013004
Diameter: 40mm
36 oz

MALLETS



TUFNOL Mallet
250mm (10")

AK-013005
Diameter: 35mm

AK-013006
Diameter: 42mm

AK-013007
Diameter: 50mm



AK-013008
230mm (9")
Diameter: 35mm

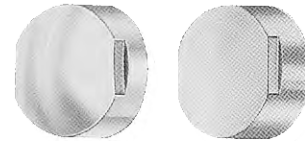

AK-013009
One metal disk, flat
One metal disk, convex



AK-013010
One plastic disk, flat
One Plastic disk, Convex



AK-013011
Wrench



MALLETS

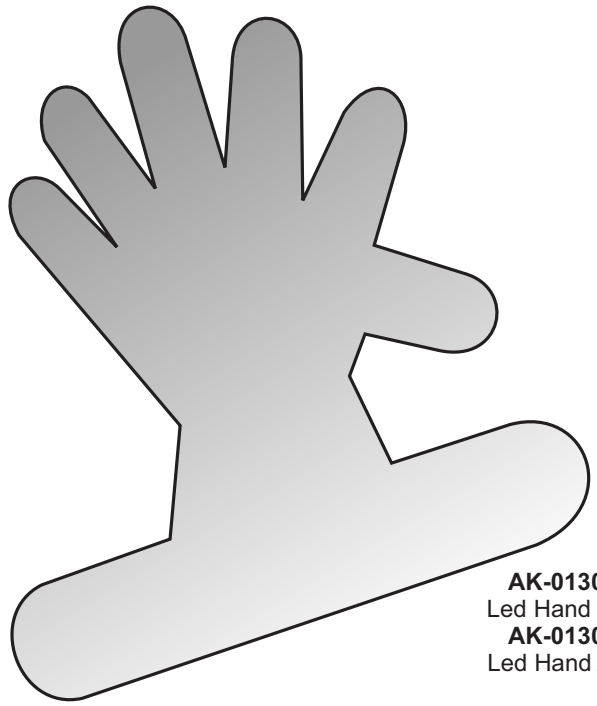

AK-013015
Led Hand Child
AK-013016
Led Hand Adult



FICKLING DENTAL
AK-013012
190mm (7 1/2")
165 gm



HERMANN
AK-013013
195mm (7 3/4")



AK-013014
185mm (7 1/4")
One side flat
One side convex

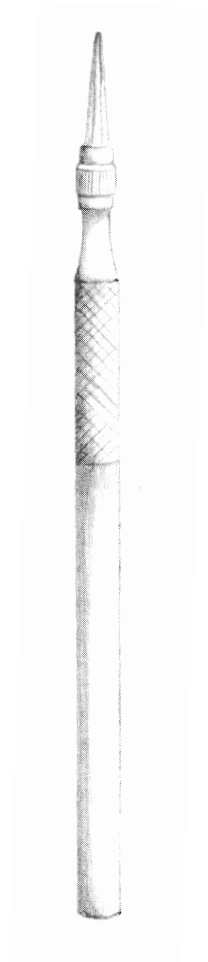

AK-013017
Sommerlad mapping pen
adjustable tip
150mm (6")

BONE HOLDING FORCEPS

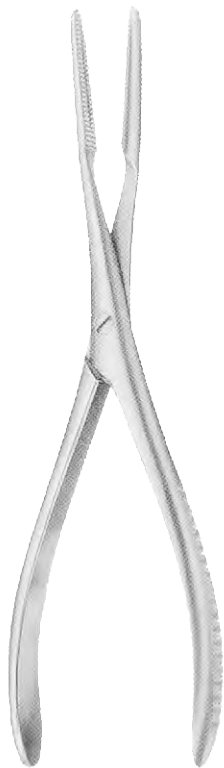

**SEQUESTUM
FORCEPS**

AK-014000
190mm (7 1/2")
Straight



**SEQUESTUM
FORCEPS**

AK-014001
190mm (7 1/2")
Angled



FERGUSSON

AK-014002
200mm (8")



BONE HOLDING FORCEPS

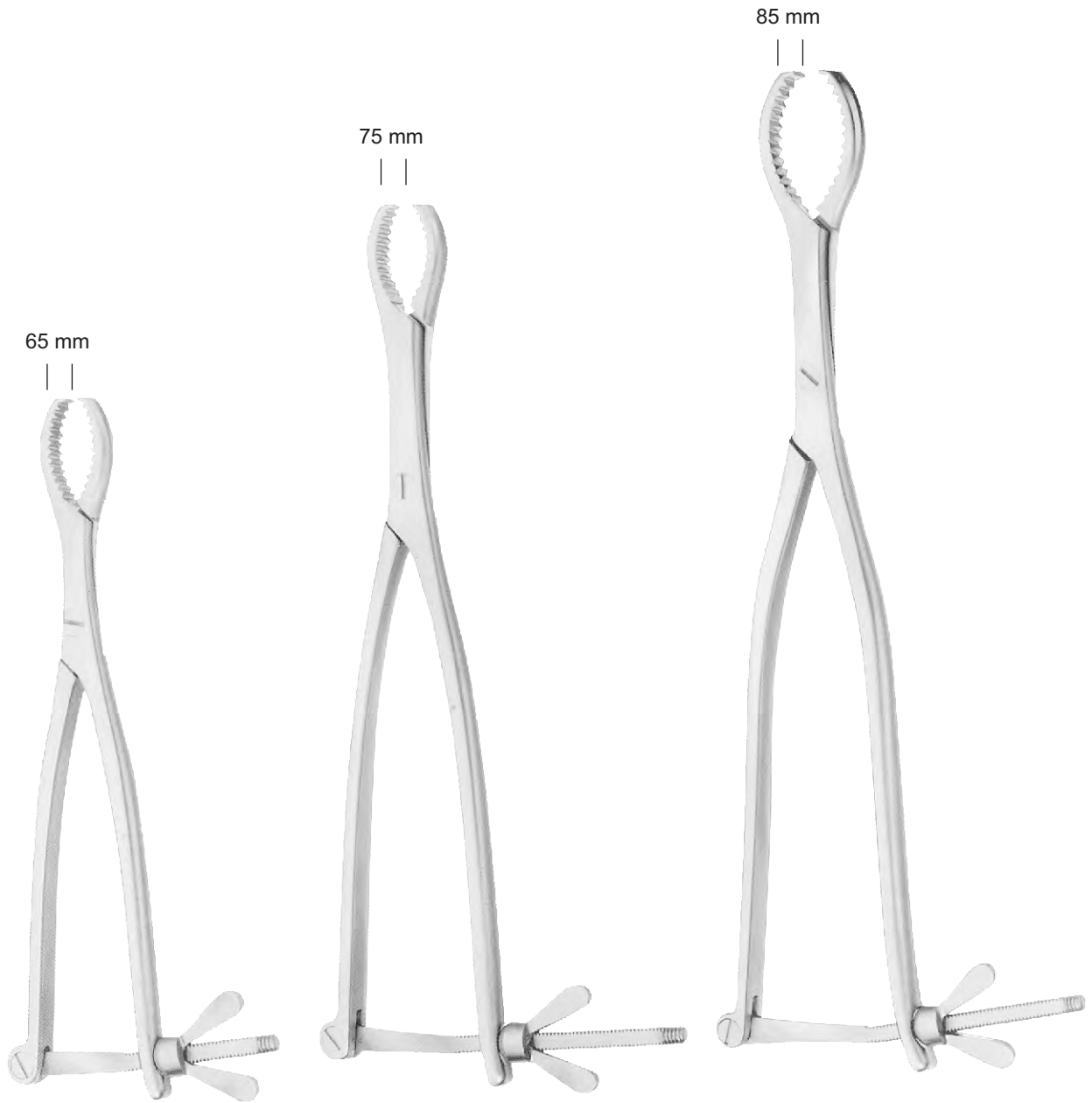

HEY GROVES

AK-014003
200mm (8")

HEY GROVES

AK-014004
255mm (10")

HEY GROVES

AK-014005
305mm (12")

BONE HOLDING FORCEPS

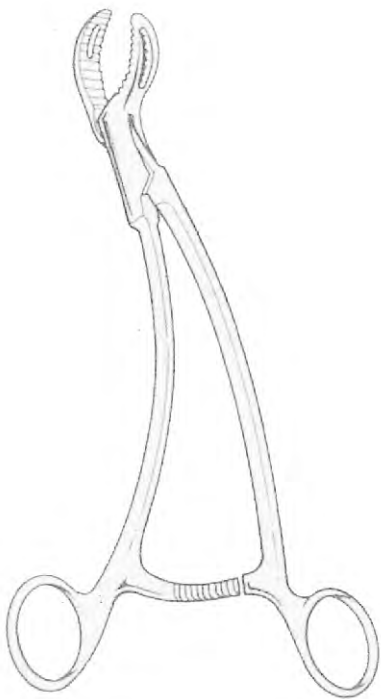

BURNS

AK-014006
185mm (7 1/4")

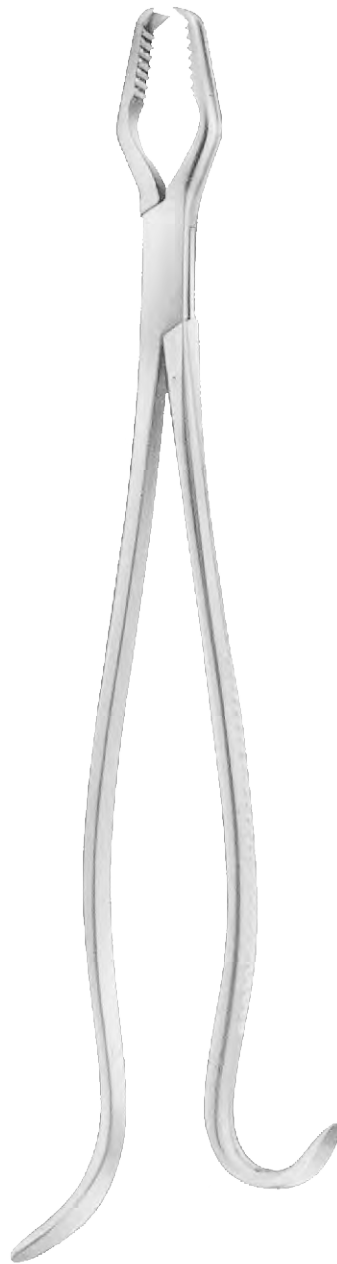

LANE

AK-014007
320mm (12 1/2")



LOWMAN

AK-014008
125mm (5")

AK-014009
175mm (6 3/4")



BONE HOLDING FORCEPS



AK-014010
250mm (93/4")



AK-014011
255mm (10")



VERBRUGGE

AK-014013
175mm (7")



VERBRUGGE



AK-014012
265mm (10 1/2")



LEWIN

AK-014014
135mm (5 1/4")

BONE HOLDING FORCEPS



LEWIN
AK-014015
205mm (8")



AK-014017
190mm (7 1/2")
Light pattern

AK-014018
190mm (7 1/2")
Heavy pattern



LEWIN
AK-014016
95mm (3 3/4")



8mm

SEMB
AK-014019
190mm (7 1/2")



75mm

KERN-MINI
AK-014020
155mm (6")



BONE HOLDING FORCEPS



KERN - LANE
AK-014021
240mm (9 1/2")



LANE
AK-014022
320mm (12 3/4")



BONE RONGEURS



BEYER

AK-015000
150mm (6")
5mm bite

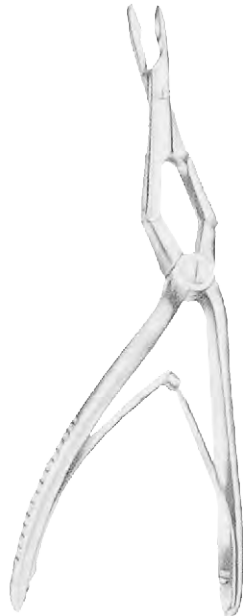

**JANSEN-MIDDLETON
SEPTUM FORCEPS**

AK-015001
200mm (8") Spoon shaped
4mm bite

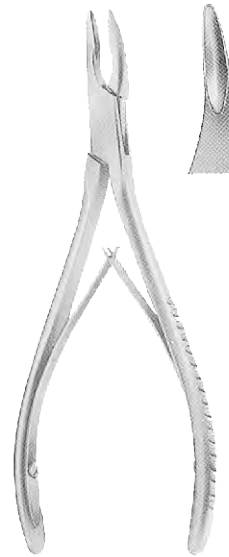

CAIRNS

AK-015002
140mm (5 1/2")
4mm bite



CAIRNS

AK-015003
140mm (5 1/2")
4mm bite



LUER

AK-015004
155mm (6")



RUSKIN

AK-015005
190mm (7 1/2")
6mm bite



BONE RONGEURS

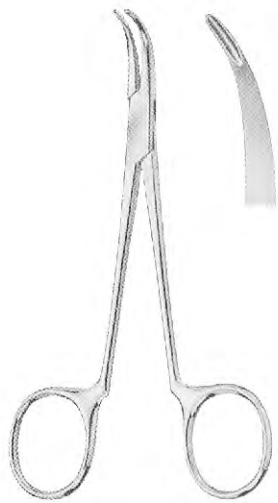

SYNOVECTOMY RONGEUR
AK-015006
 130mm (5 1/8") Jaw width 2mm

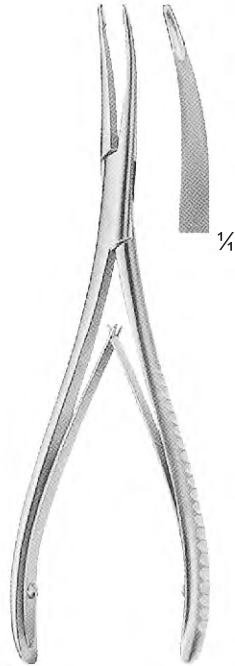

SYNOVECTOMY RONGEUR
AK-015007
 175mm (7")



JANSEN
AK-015008
 150mm (6")

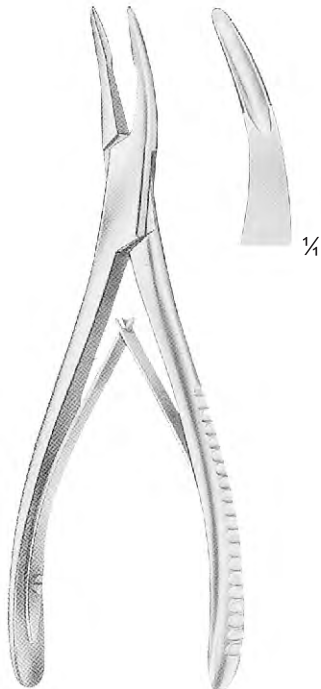

HARTMANN
AK-015009
 180mm (7")



MEAD
AK-015010
 165mm (6 1/2")



NORTHFIELD
AK-015011
 200mm (8")
 10mm bite



BONE RONGEURS



PENNYBACKER

AK-015012
200mm (8")
4mm bite



WILMS

AK-015013
200mm (8")
4mm bite



HEANLEY

AK-015014
175mm (7")
4mm bite



TROTTER

AK-015015
200mm (8")
10mm bite



KILLEARN

AK-015016
197mm (73/4")
3mm bite

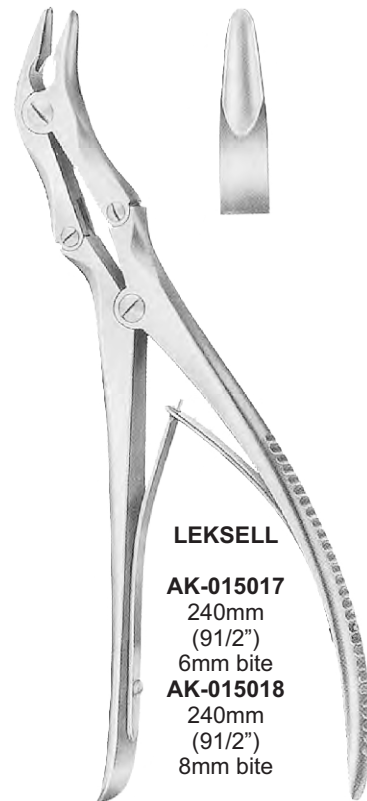

LEKSELL

AK-015017
240mm
(91/2")
6mm bite
AK-015018
240mm
(91/2")
8mm bite



BONE RONGEURS

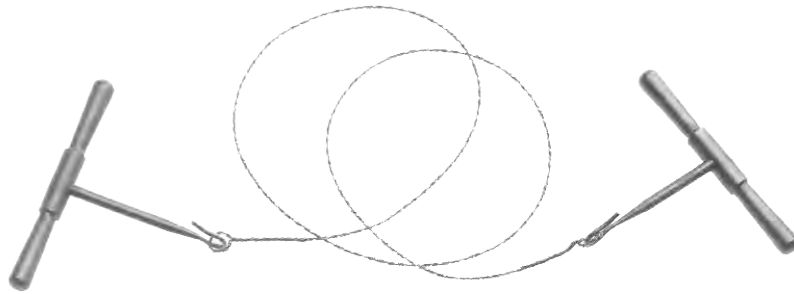

GIGLI SAW WITH HANDLE

AK-015022
500mm (20")

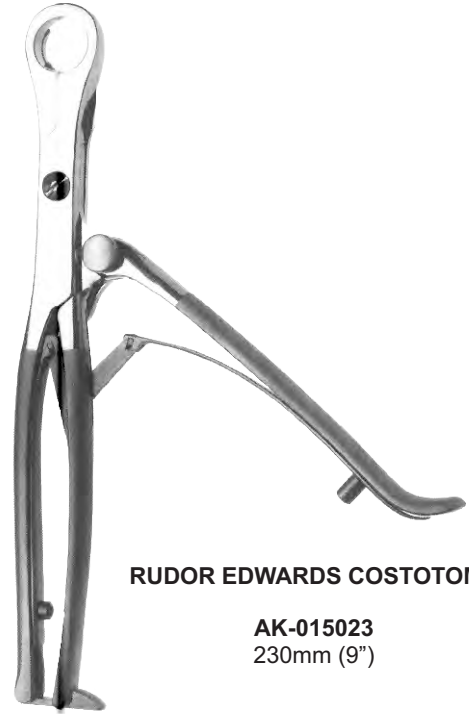

RUDOR EDWARDS COSTOTOME

AK-015023
230mm (9")

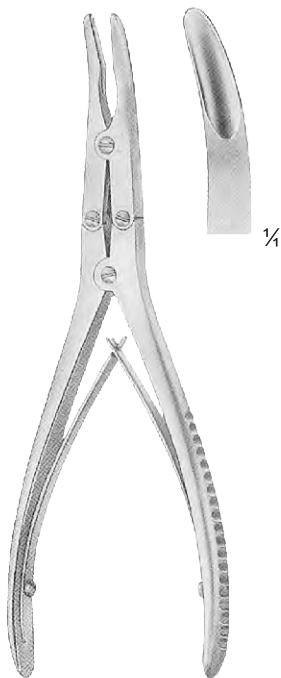

LUER-JANSEN

AK-015019
170mm (63/4") 4mm bite



BEYER

AK-015020
180mm (7")



BEYER

AK-015021
200mm (8")



BONE RONGEURS



ZAUFAL-JANSEN

AK-015024
240mm (9 1/2")



ECHLIN

AK-015025
240mm (9 1/2")

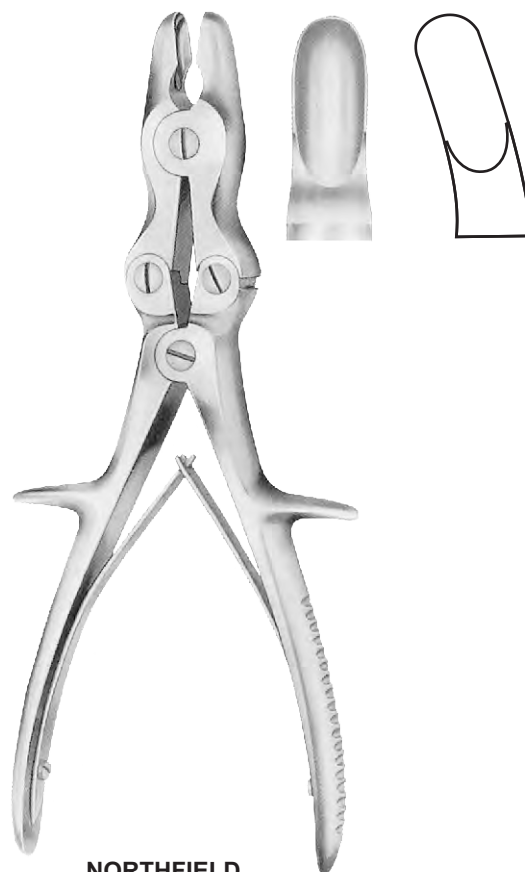

NORTHFIELD

AK-015026
225mm (9")
10mm bite



BONE RONGEURS

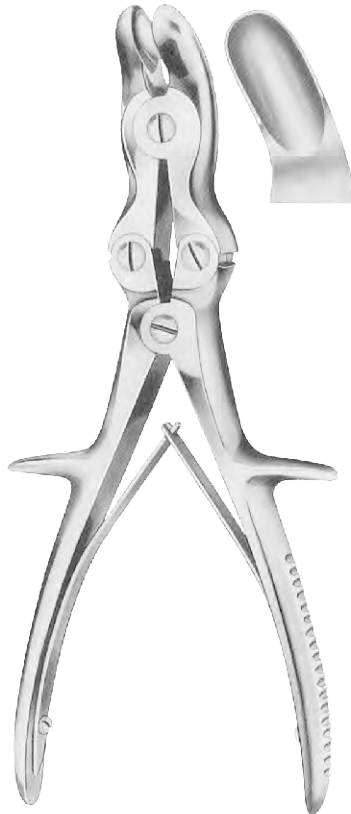

SARGENT (VAN HAVRE)

AK-015027
220mm (8 3/4")
10mm bite



OLIVECRONA

AK-015028
230mm (9")
6mm bite



STILLE-RUSKIN

AK-015029
240mm (9 1/2")



BONE RONGEURS

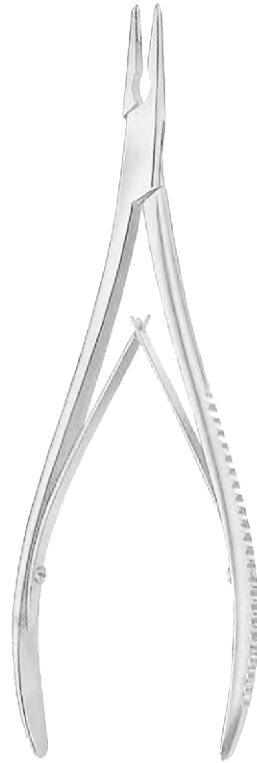

LEMPERT
190mm (7 1/2")
3mm bite

AK-015030 - Straight
AK-015031 - Curved



JANSEN - STRUYCKEN
SEPTUM FORCEPS

AK-015032
210mm (8 1/4")





DISC RONGEURS

BECK RONGEUR

AK-015033
Shaft: 130mm (5 1/8")
2mm bite



CUSHING (CAIRNS) RONGEUR

Shaft: 130mm (5 1/8")

AK-015034
4mm bite

Q17-15035
5mm bite

Q17-15036
7mm bite



CUSHING RONGEURS

Shaft: 130mm (5 1/8")

AK-015037
3mm bite

Q17-15038
4mm bite

Q17-15039
5mm bite



CUSHING RONGEURS

Shaft 130mm (5 1/8")

AK-015040
3mm bite

AK-015041
4mm bite





DISC RONGEURS

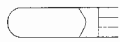
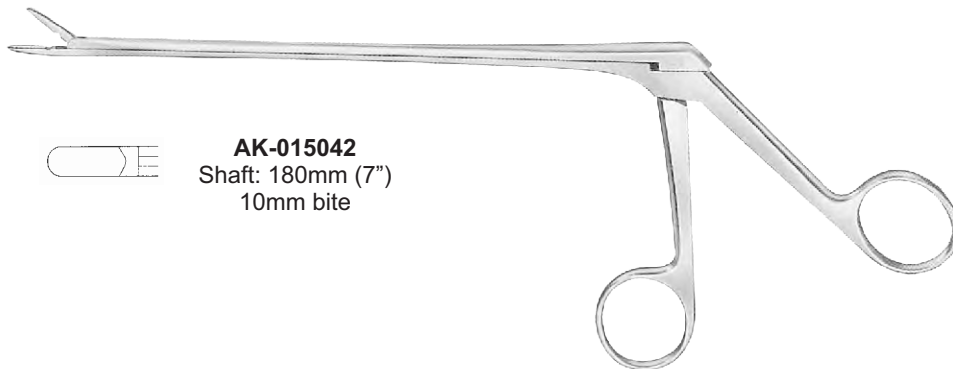

AK-015042
Shaft: 180mm (7")
10mm bite

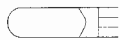

AK-015043
Shaft: 180mm (7")
10mm bite

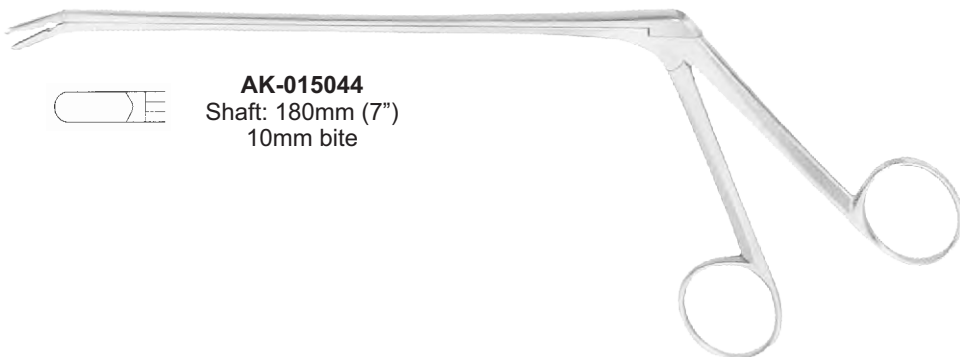

AK-015044
Shaft: 180mm (7")
10mm bite



BONE CUTTING FORCEPS



LISTON
Straight



AK-016000
140mm (5 1/2")



AK-016001
170mm (6 3/4")



AK-016002
200mm (8")



AK-016003
220mm (8 3/4")



LISTON
Curved on flat

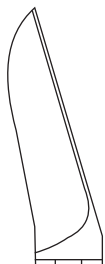

AK-016004
170mm (6 3/4")

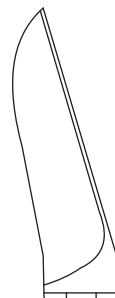

AK-016005
200mm (8")

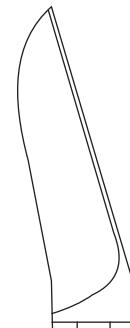

AK-016006
220mm (8 3/4")

BONE CUTTING FORCEPS

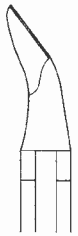

STAMM

AK-016007
150mm (6")



**HORSLEY
LISTON**

AK-016008
255mm (10")
Straight

AK-016009
255mm (10")
Curved on flat



MCINDOE

AK-016010
170mm (6 3/4")



BONE CUTTING FORCEPS

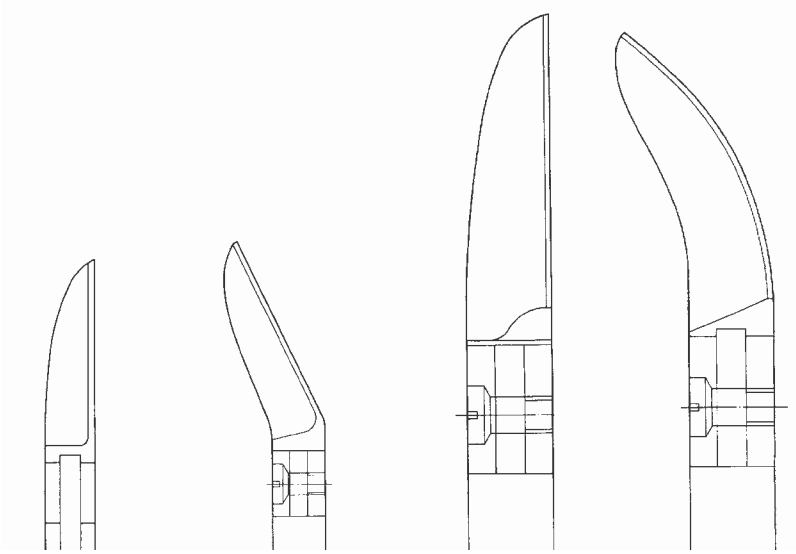

AK-016015
150mm (6")



RUSKIN - LISTON

AK-016011
190mm (7 1/2")
Straight

AK-016012
190mm (7 1/2")
Angled on flat



STILLE LISTON

AK-016013
280mm (11")
Straight

AK-016014
275mm (10 3/4")
Curved on flat



AK-016016
145mm (5 3/4")

INSTRUMENTS

BONE CUTTING FORCEPS



WARD

AK-016017
170mm (63/4")

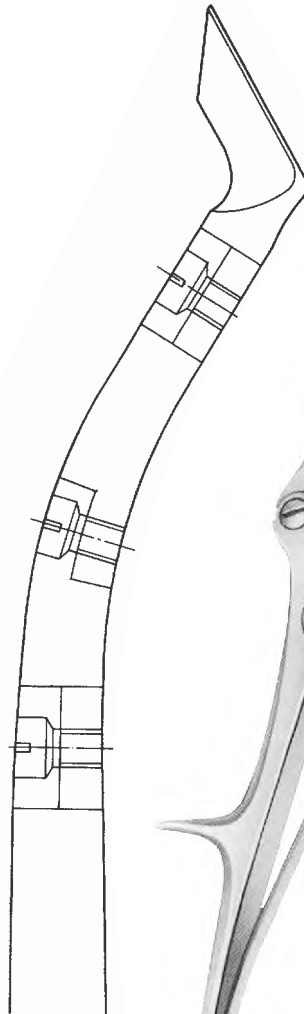

DE VILBISS

AK-016018
210mm (81/4")



LISTON (TUDOR EDWARDS)

AK-016019
265mm (101/2")



PLASTER CAST REMOVAL INSTRUMENTS



PLASTER KNIFE

AK-017000
180mm (7")



CAST BENDING FORCEPS

AK-017001
180mm (7")
AK-017002
240mm (9 1/2")



**HENNIG
PLASTER SPREADER**

AK-017003
270mm (10 3/4")



**GUY'S (BOHLER)
PLASTER SHEARS**

AK-017004
240mm (9 1/2")
Flattened probe end

PLASTER CAST REMOVAL INSTRUMENTS



PLASTER SHEARS

AK-017005
160mm (6 1/4")



PLASTER SHEARS

AK-017006
200mm (8")

AK-017007
230mm (9")



PLASTER SHEARS

AK-017008
235mm (9 1/4")



BONE & RIB SHEARS



AK-018001
230mm (9")



AK-018002
220mm(83/4")

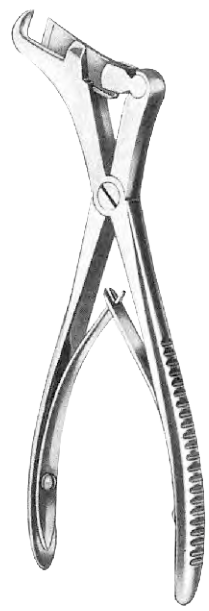

AK-018003
170mm (63/4")



GLUCK
AK-018004
220mm (83/4")

With eccentric sliding blade



STILLE
AK-018005
210mm (81/4")

INSTRUMENTS

BONE & RIB SHEARS



SAUERBRUCH

AK-018006
260mm (10 1/4")



GIERTZ STILLE

AK-018007
270mm (10 1/2")

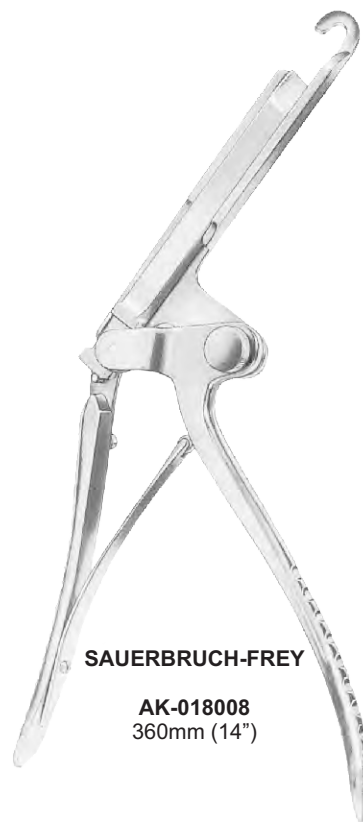

SAUERBRUCH-FREY

AK-018008
360mm (14")



LEBSCHER

AK-018009
250mm (10")

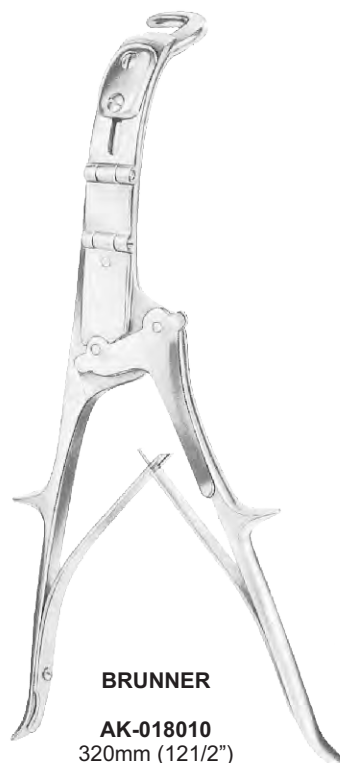

BRUNNER

AK-018010
320mm (12 1/2")



LEBSCHER

AK-018011
245mm (9 3/4")



RIB SPREADERS

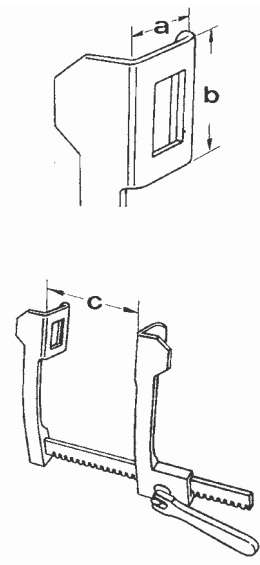

COOLEY
AK-018012
 For new borns

A	B	C
12 mm	16 mm	95 mm



COOLEY
AK-018013
 Pediatric size

A	B	C
15 mm	30 mm	140 mm
21 mm	44 mm	150 mm



COOLEY
AK-018014
 For adults

A	B	C
35 mm	50 mm	200 mm

INSTRUMENTS

RIB SPREADERS

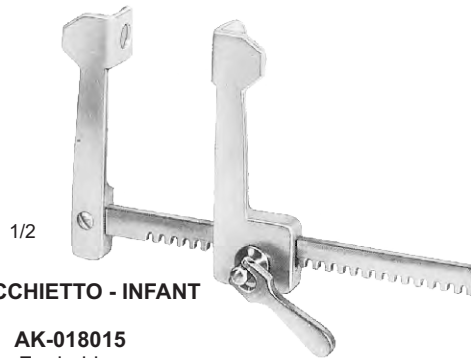
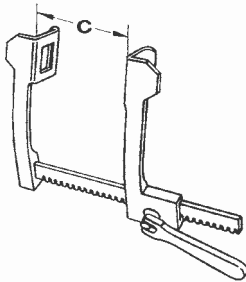
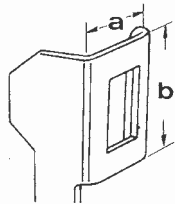

FINOCCHIETTO - INFANT

AK-018015
For babies

a	b	c
15mm	15mm	75mm



FINOCCHIETTO-BABY

AK-018016
Child size

a	b	c
31mm	31mm	100mm

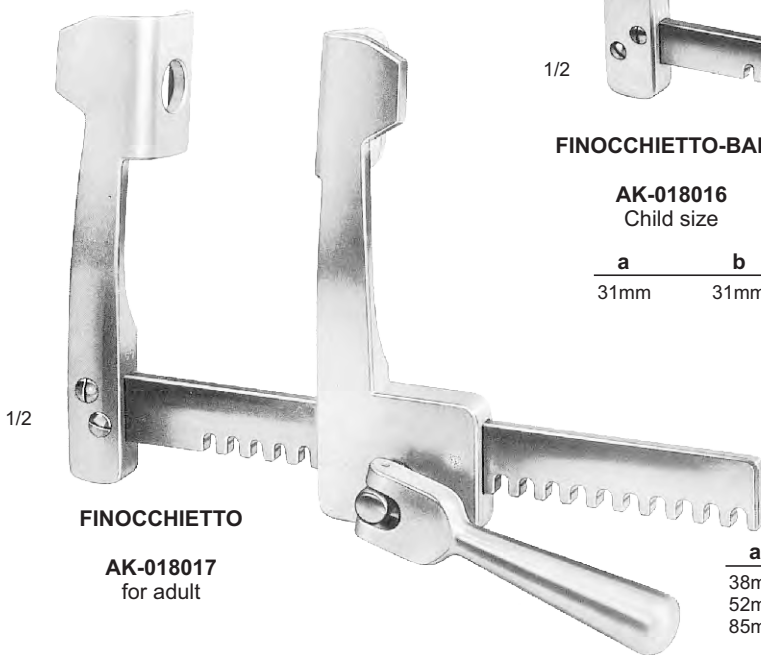

FINOCCHIETTO

AK-018017
for adult

a	b	c
38mm	44mm	135mm
52mm	62mm	175mm
85mm	65mm	175mm



RIB SPREADERS

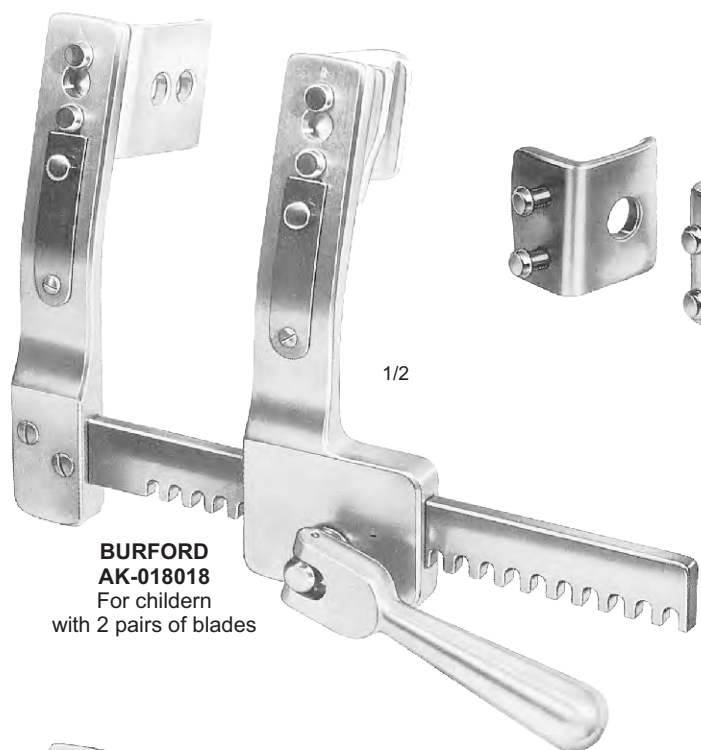

1/2

**BURFORD
AK-018018**
For children
with 2 pairs of blades

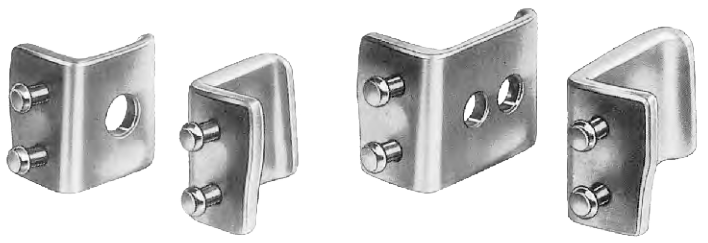

a	b	c
48mm	42mm	135mm
34mm	42mm	135mm

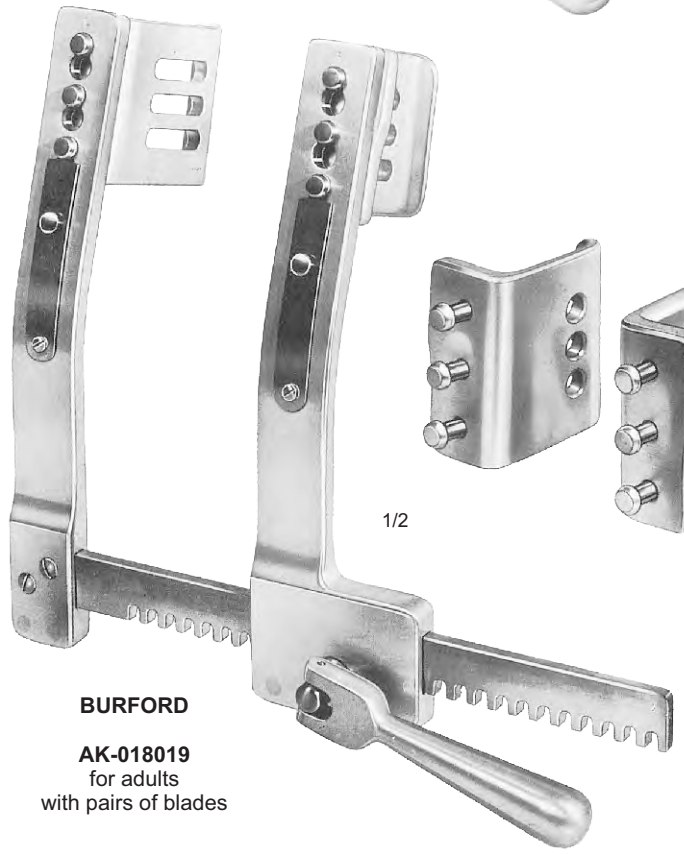

1/2

**BURFORD
AK-018019**
for adults
with pairs of blades

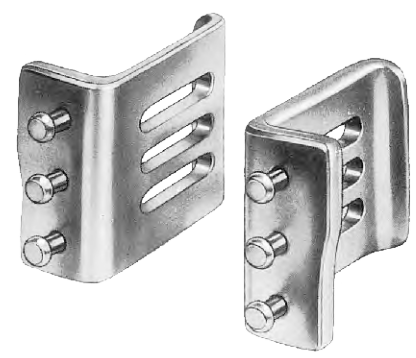

a	b	c
64mm	62mm	180mm
47mm	62mm	
65mm	62mm	260mm
47mm	62mm	
65mm	62mm	300mm
47mm	62mm	

INSTRUMENTS

RIB SPREADERS

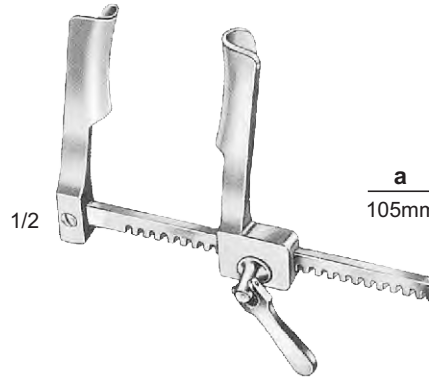
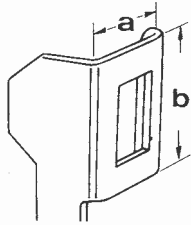

CASTANEDA

AK-018020

a	b	c
105mm	32mm	65mm

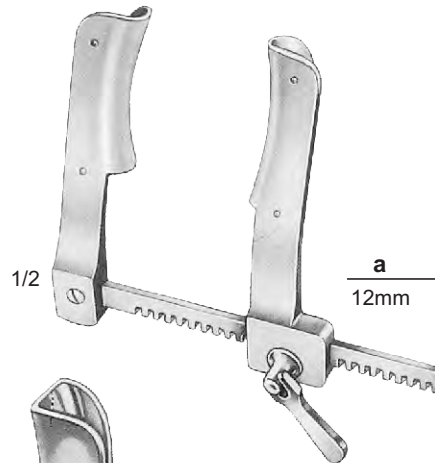
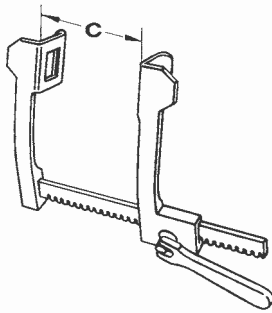

CASTANEDA

AK-018021

a	b	c
12mm	45mm	70mm

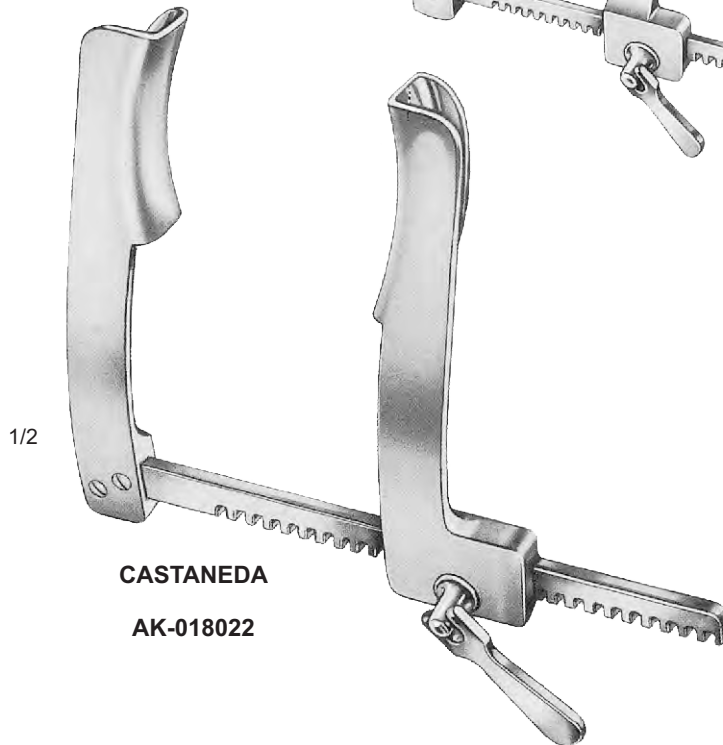

CASTANEDA

AK-018022



RIB SPREADERS

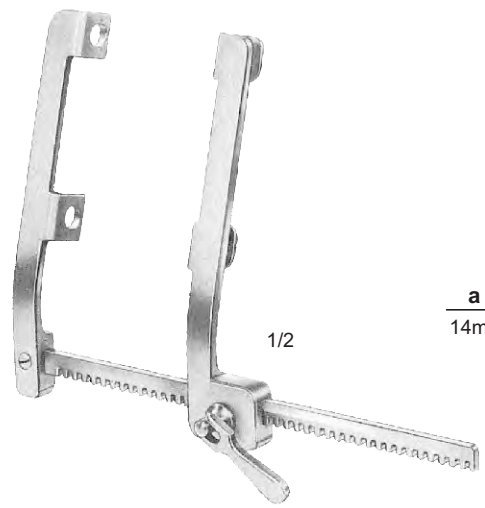

FINOCCHIETTO (Modif)
AK-018023

a	b	c	d
14mm	14mm	120mm	110mm

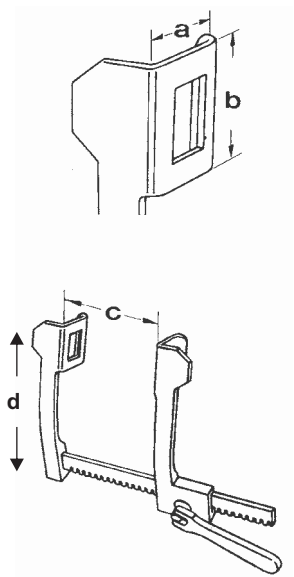

HAIGHT
AK-018024

a	b	c
30mm	30mm	90mm

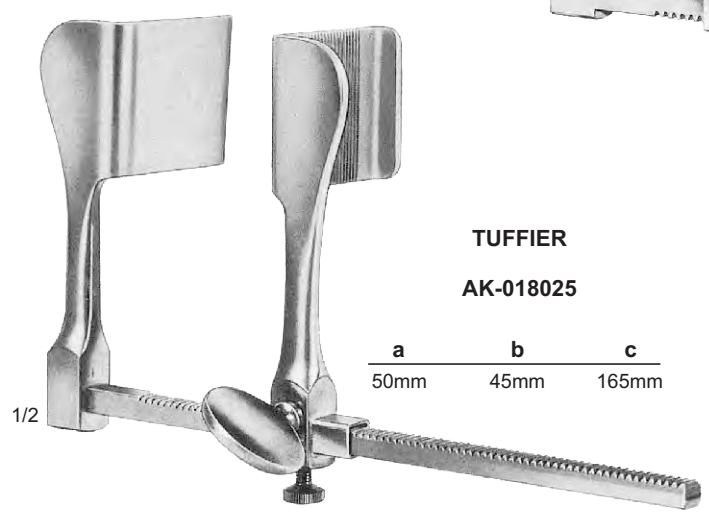
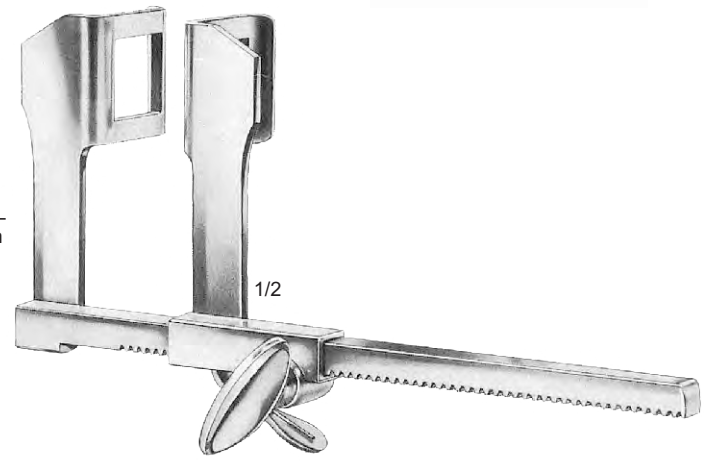

TUFFIER
AK-018025

a	b	c
50mm	45mm	165mm

INSTRUMENTS

RIB SPREADERS

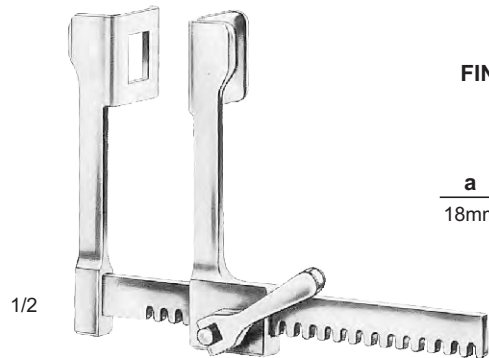
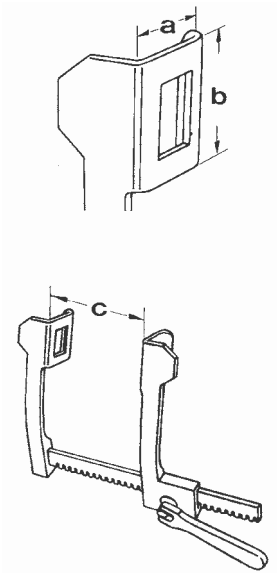

FINOCCHIETTO - BABY

AK-018026

a	b	c
18mm	20mm	75mm

FINOCCHIETTO

AK-018027

Small pattern

- a: 40mm
- b: 40mm
- c: 165mm

Medium pattern

- a: 45mm
- b: 65mm
- c: 200mm

Large pattern

- a: 70mm
- b: 65mm
- c: 250mm





RIB SPREADERS

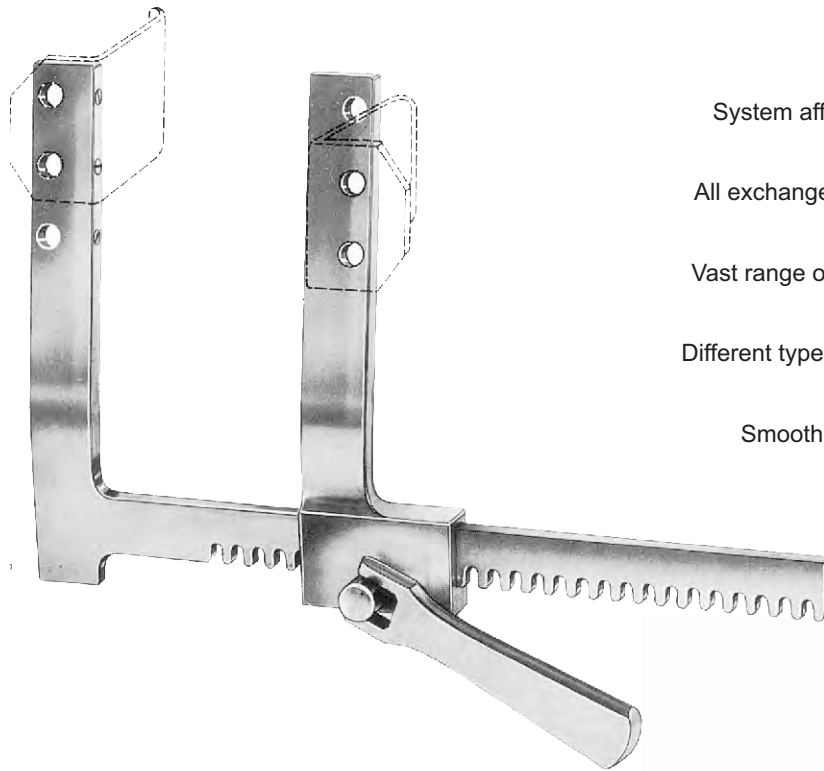

Advantages:

- System affording quick and problem free exchange of blades
- All exchangeable blades with instant locking plug-in system
- Vast range of fix and adapting exchangeable blades
- Different types of exchangeable blades can be fixed to either side
- Smooth surfaces, Sutures stay free
- Easy cleaning

FINOCCHIETTO

AK-018028
Retractor, Small size
with 3 pair of exchangeable blades

AK-018029
Retractor, Small size only

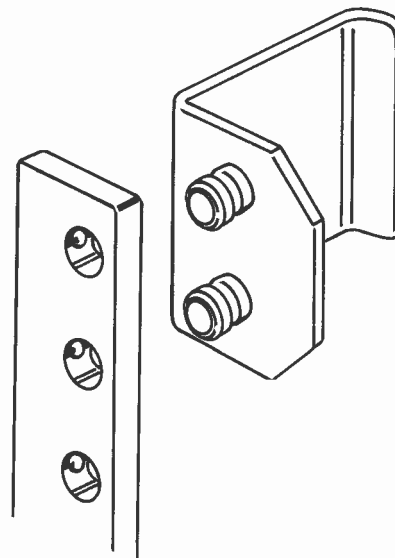

RIB SPREADERS

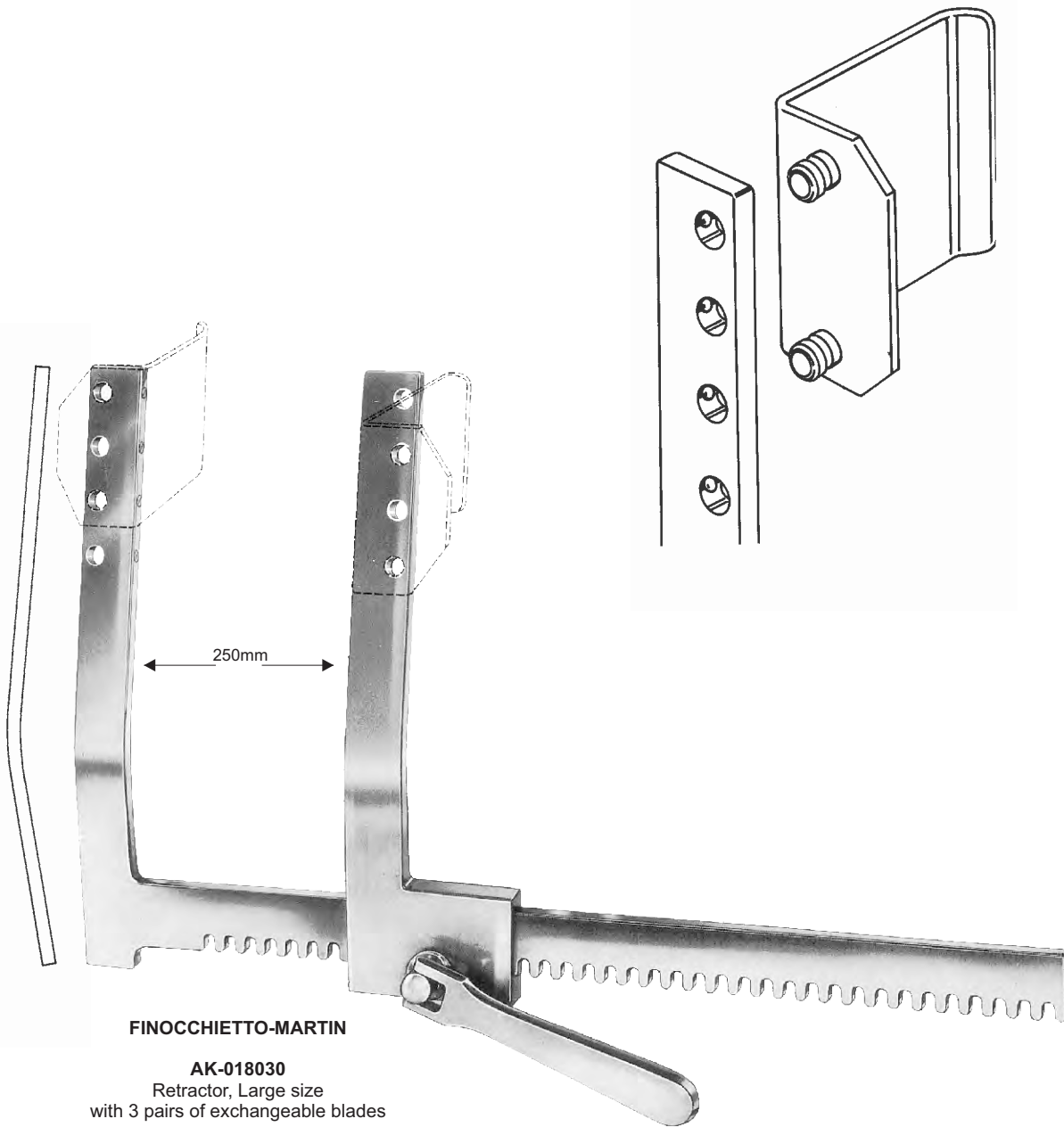

FINOCCHIETTO-MARTIN

AK-018030

Retractor, Large size
with 3 pairs of exchangeable blades

AK-018031

Retractor, Large size only



RIB SPREADERS



QUERVAIN
AK-018032

a	b	c
35mm	50mm	180mm



RIB SPREADERS

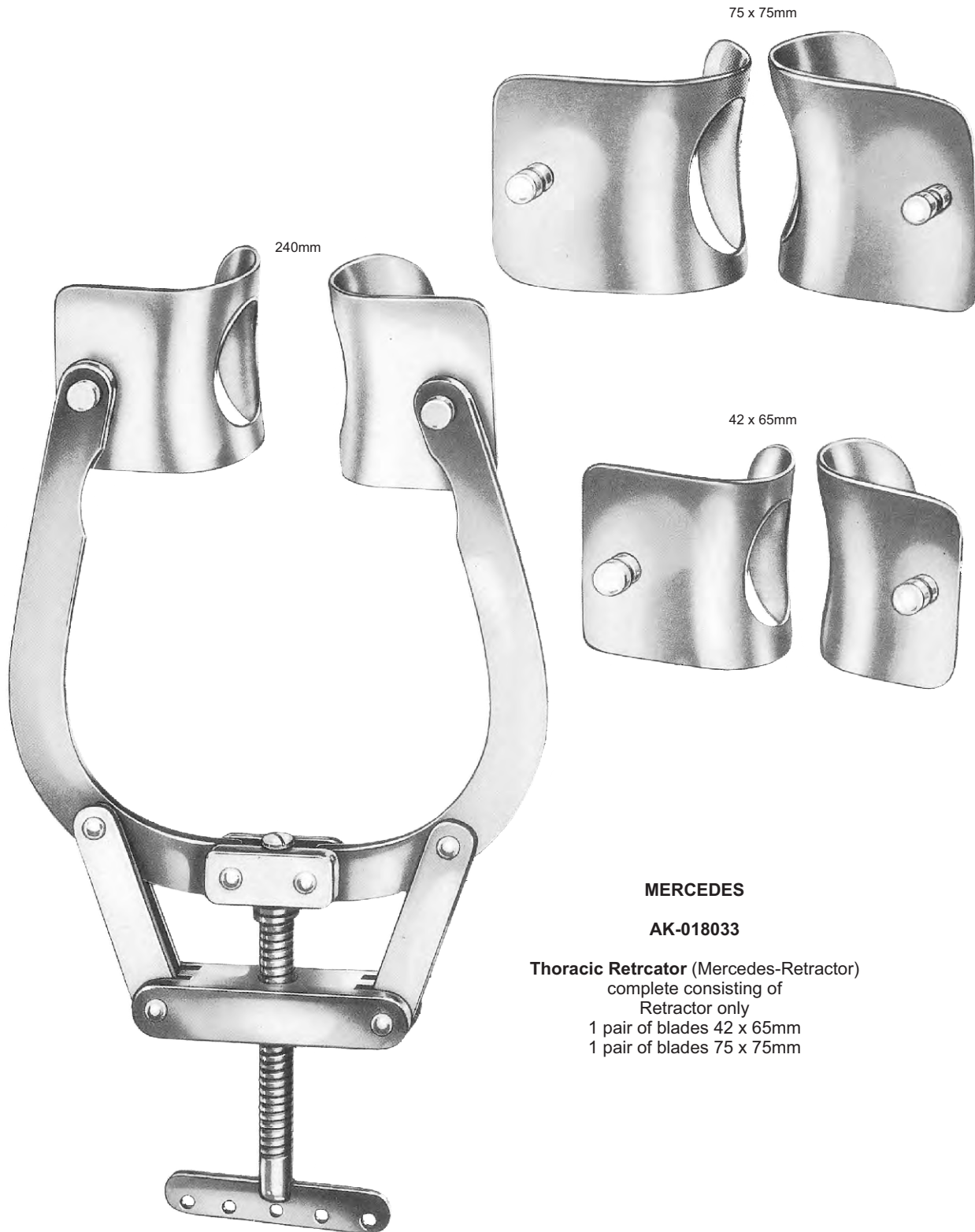

MERCEDES

AK-018033

Thoracic Retractor (Mercedes-Retractor)
complete consisting of
Retractor only
1 pair of blades 42 x 65mm
1 pair of blades 75 x 75mm



RIB SPREADERS



AK-018034
190mm (7 1/2")

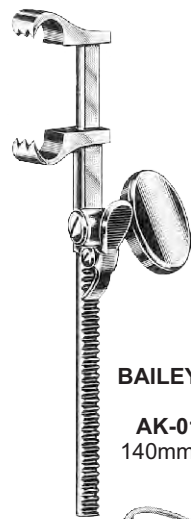

BAILEY-BABY
AK-018035
140mm (5 1/2")

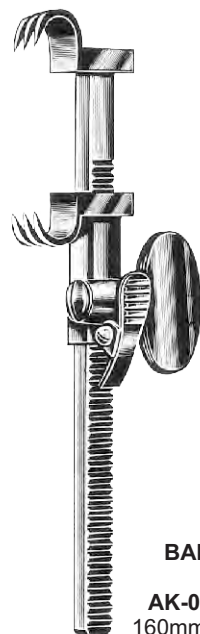

BAILEY
AK-018036
160mm (6 1/4")

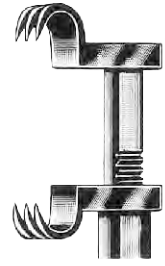

BAILEY GIBBON
AK-018037
160mm (6 1/4")



ALLISON
AK-018038
300mm (12")
AK-018039
320mm (12 1/2")



ALLISON
AK-018040
260mm (10 1/4")

INSTRUMENTS

BRONCHUS FORCEPS LIGATURE FORCEPS

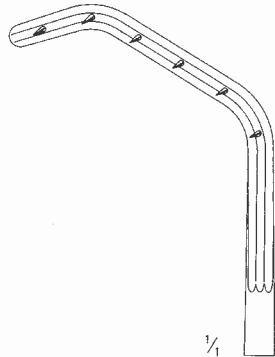
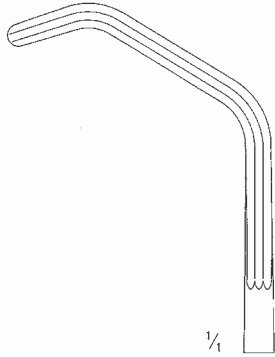

S14-18042



S14-18043

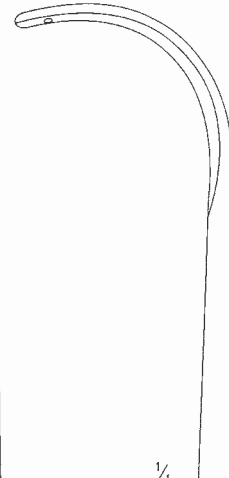

S14-18044



PRICE-THOMAS

AJ-018041
220mm (8 3/4")

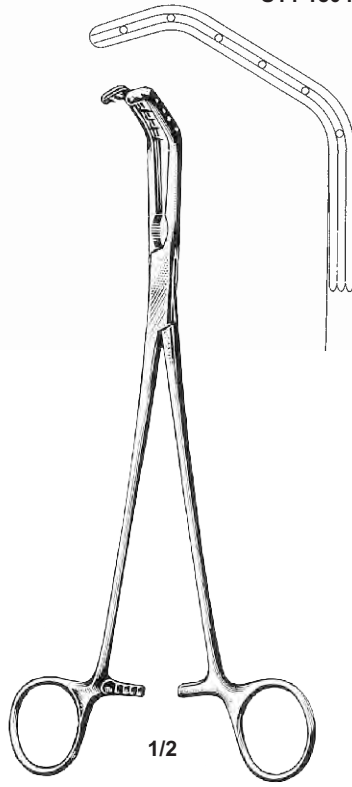

PRICE-THOMAS

AJ-018042
220mm (8 3/4")



SEMB

AJ-018043
240mm (9 1/2")



TISSUE AND ORGAN HOLDING FORCEPS

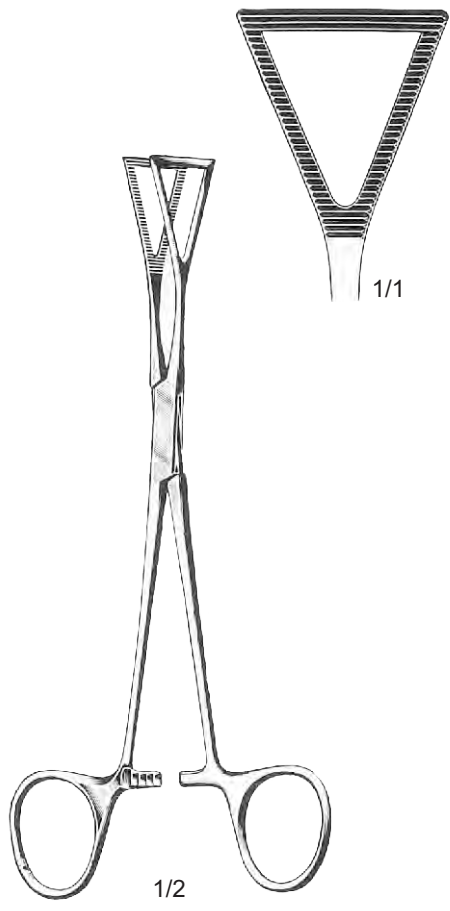

1/2

LOVELACE
Straight

AJ-018045
200mm (8")

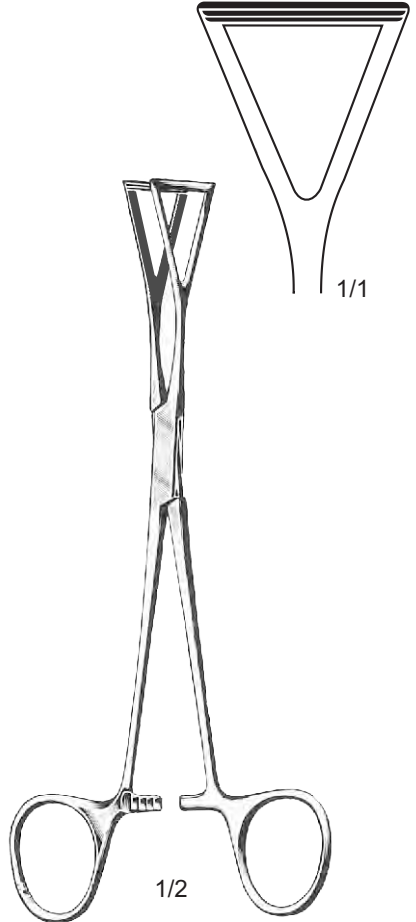

1/2

LOVELACE

AJ-018046
200mm (8")

INSTRUMENTS

ATRAUMA BULLDOG CLAMPS

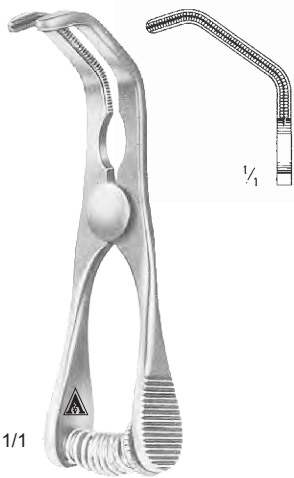

1/1

DE-BAKEY SATINSKY

AJ-018047
70mm (23/4")



1/1

DE BAKEY-CAROTIS

AJ-018048
90mm (31/2")

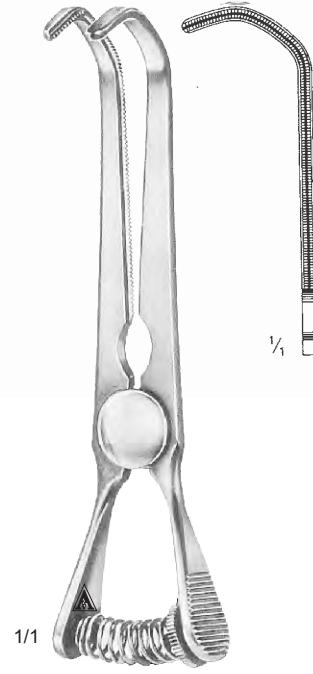

1/1

DE BAKEY SATINSKY

AJ-018049
100mm (4")

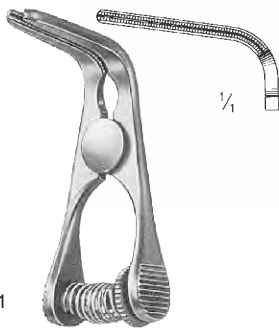

1/1

GLOVER

AJ-018050
50mm (2")

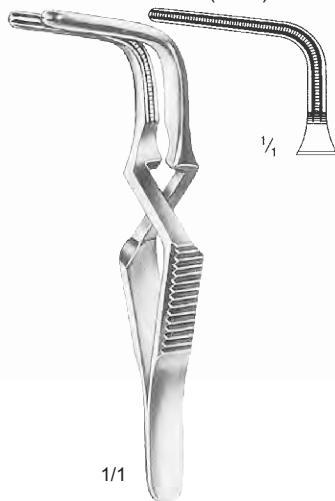

1/1

SANTULLI

AJ-018051
70mm (23/4")

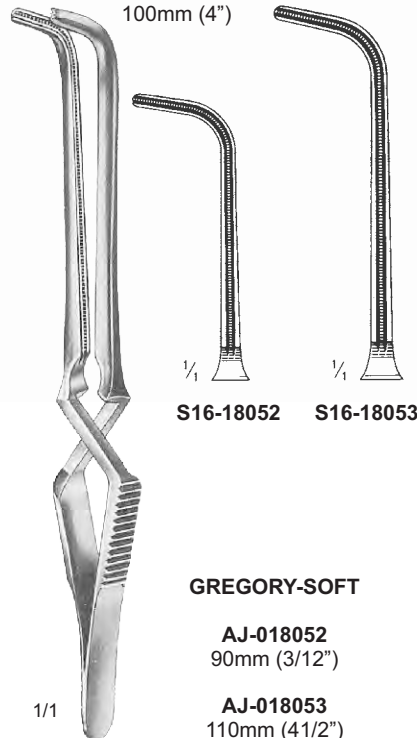

1/1

GREGORY-SOFT

AJ-018052
90mm (31/2")

AJ-018053
110mm (41/2")



ATRAUMA HEMOSTATIC FORCEPS

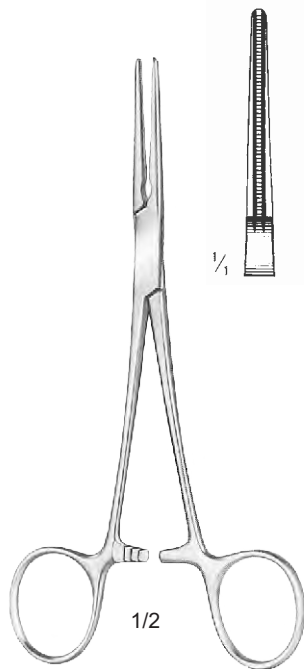

DE BAKHEY-RANKIN
S17-18054
Straight
160mm (6 1/4")

AJ-018055
Curved
160mm (6 1/4")

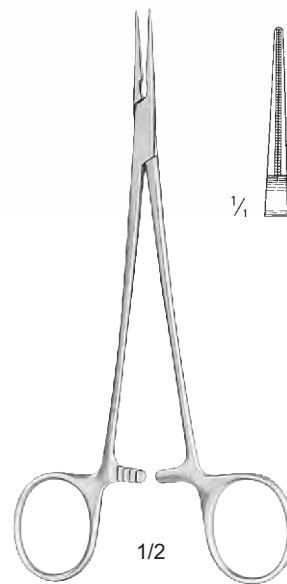
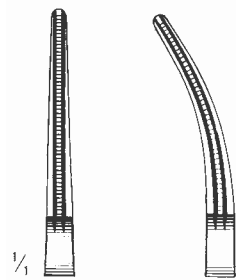

DE BAKHEY-MOSQUITO
AJ-018056
Straight
150mm (6")

Curved
150mm (6")

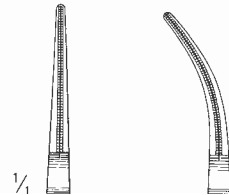

ATRAUMA CARDIOVASCULAR FORCEPS



1/2

OCHSNER

AJ-018057
235mm (9 1/4")



1/1



1/2

DIETRICH

AJ-018058
210mm (8 1/4")



1/1



ATRAUMA CARDIOVASCULAR FORCEPS

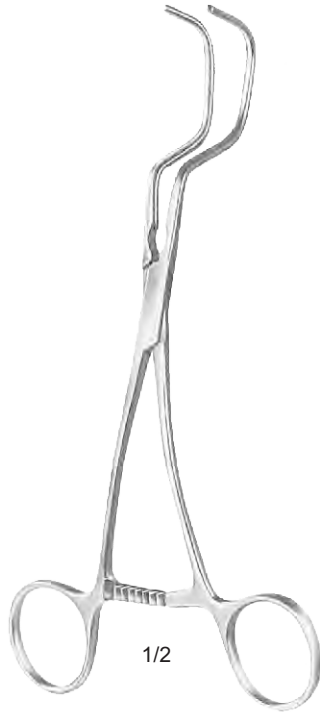

1/2

DALE

AJ-018059
185mm (7")

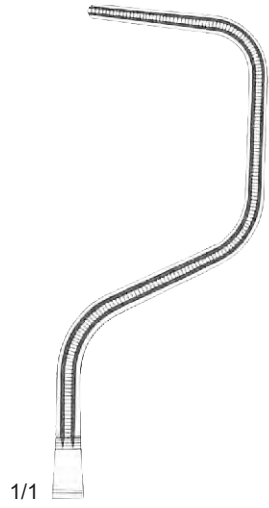

1/1



1/2

DALE

AJ-018060
170mm (6 1/2")

1/1

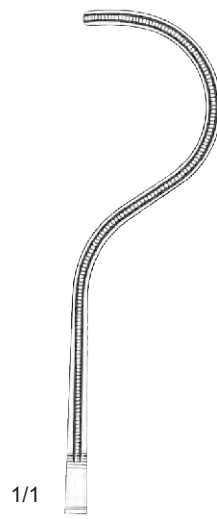

1/1

AJ-018061
175mm (7")

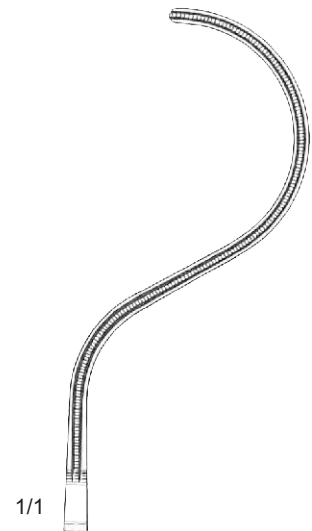

1/1

AJ-018062
185mm (7 1/4")

INSTRUMENTS

ATRAUMA CARDIOVASCULAR FORCEPS

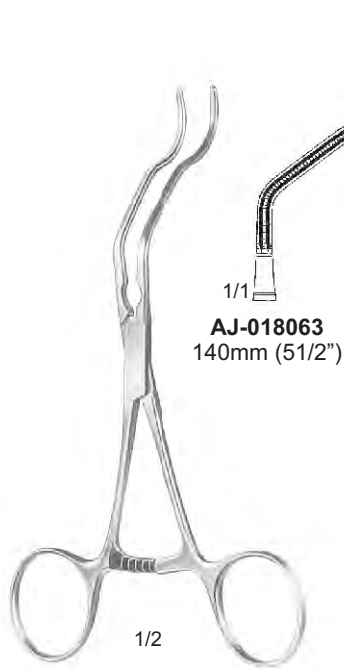

AJ-018063
140mm (5 1/2")

GREGORY



AJ-018064
160mm (6 1/4")

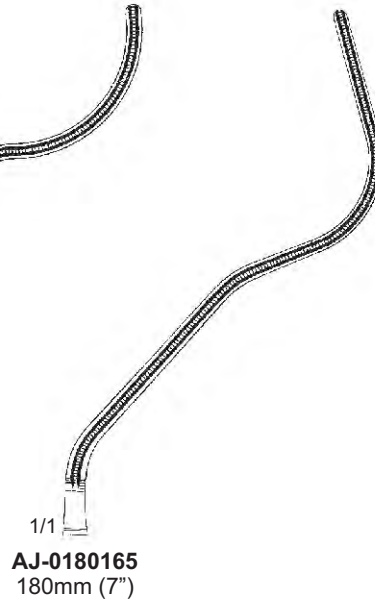

AJ-0180165
180mm (7")

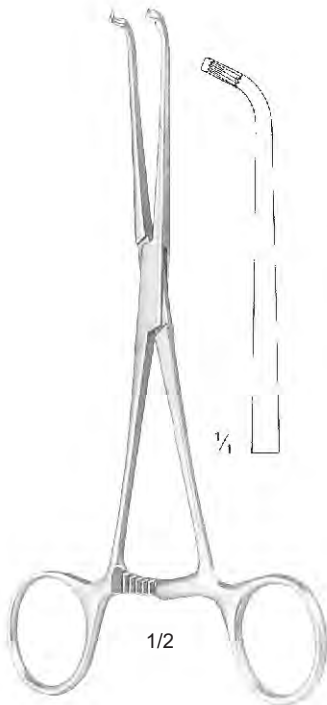

AJ-018066
180mm (7")

JAVID

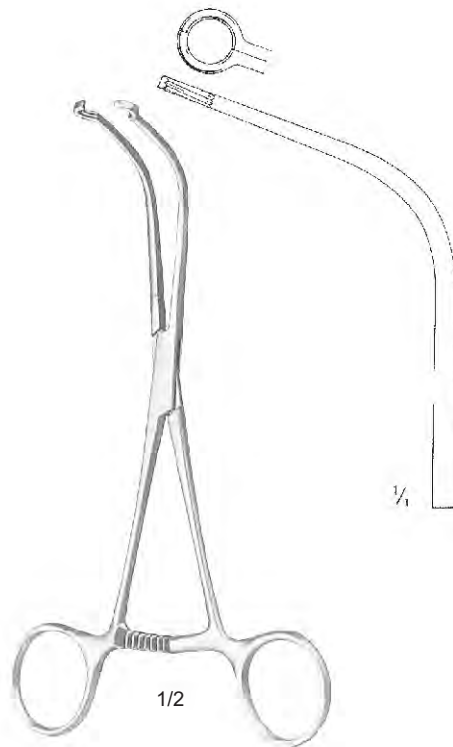

AJ-018067
190mm (7 1/2")

JAVID



ATRAUMA CARDIOVASCULAR FORCEPS

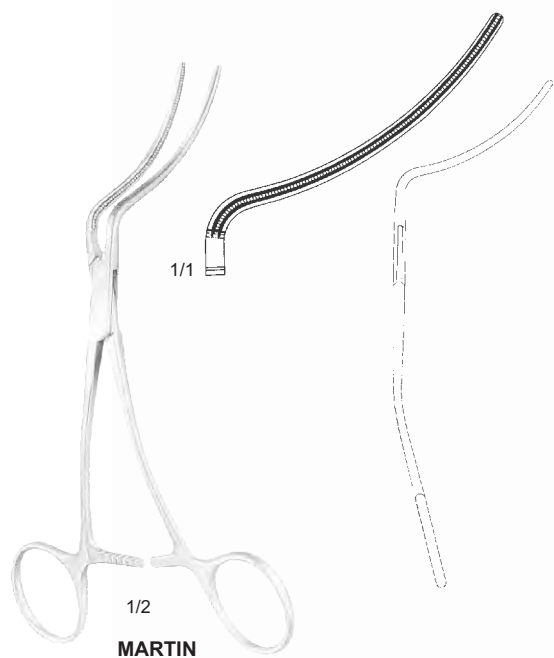

MARTIN
AJ-018068
160mm (6 1/4")

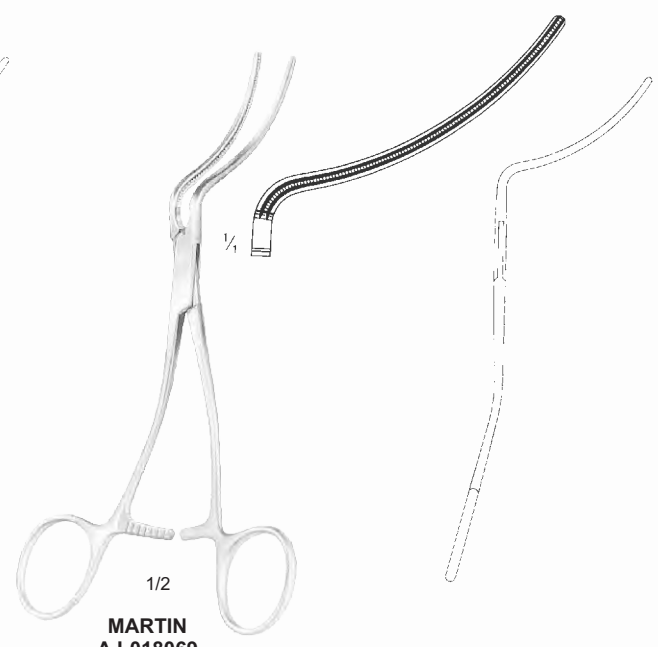

MARTIN
AJ-018069
170mm (6 1/2")

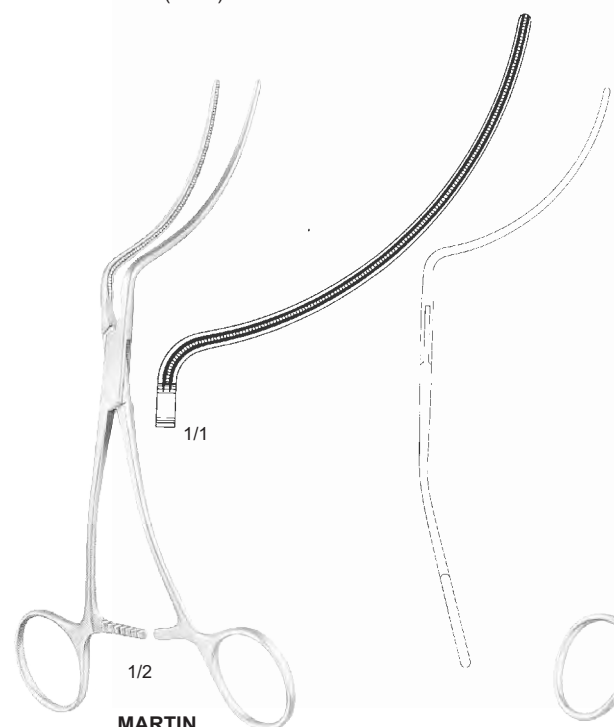

MARTIN
AJ-018070
180mm (7")

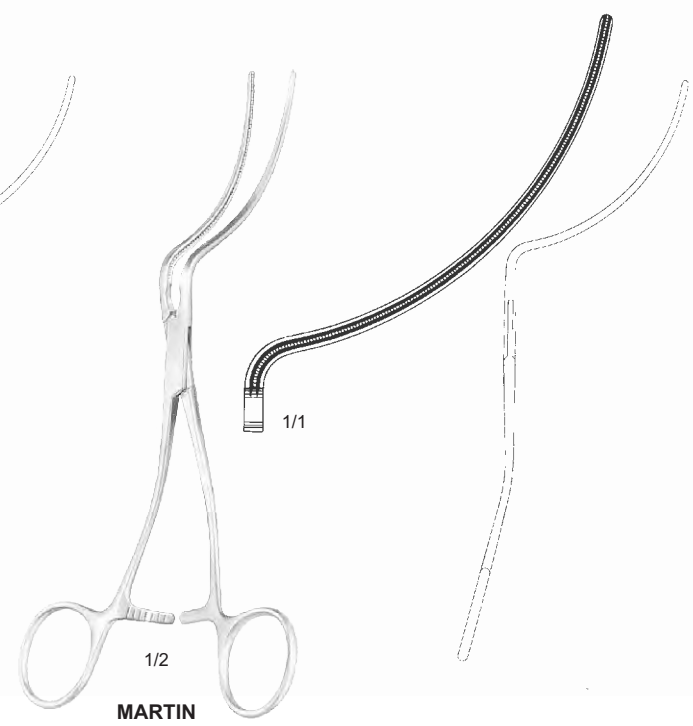

MARTIN
AJ-018071
200mm (8")

INSTRUMENTS

VASCULAR MEASURING DEVICE

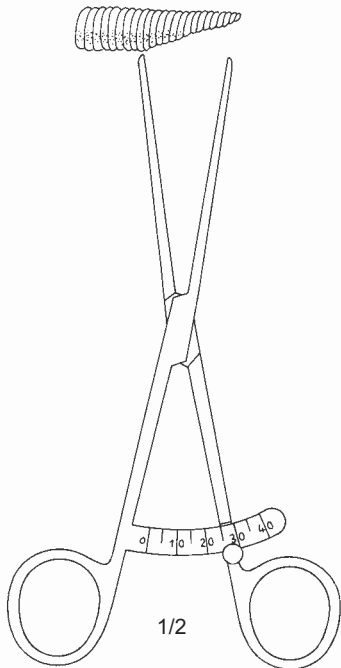
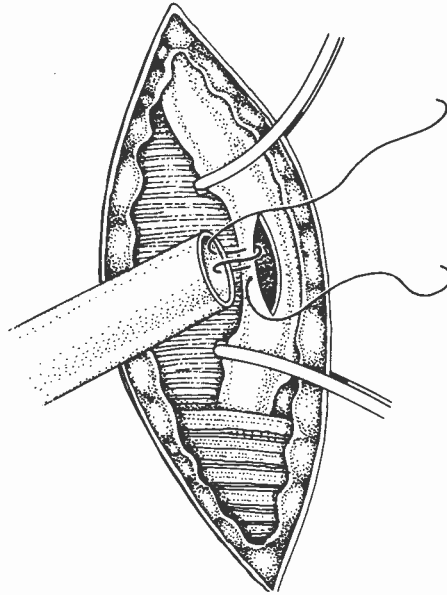

MEASURING FORCEPS

AJ-018072
Straight - 180mm (7")

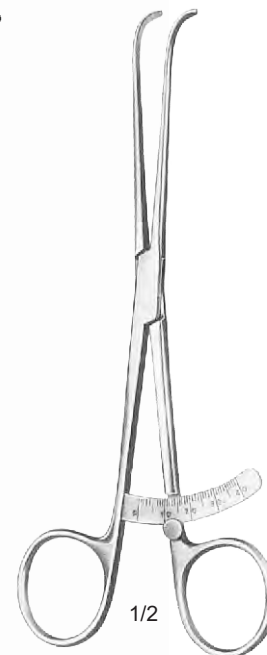
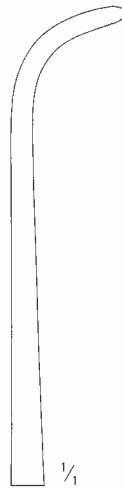

MEASURING FORCEPS

AJ-018073
Straight - 180mm (7")



ATRAUMA CARDIOVASCULAR FORCEPS

Cooley type caval occlusion used during cardiopulmonary By-Pass for occluding The vena caval The tips of the instrument permit flow indwelling cannula

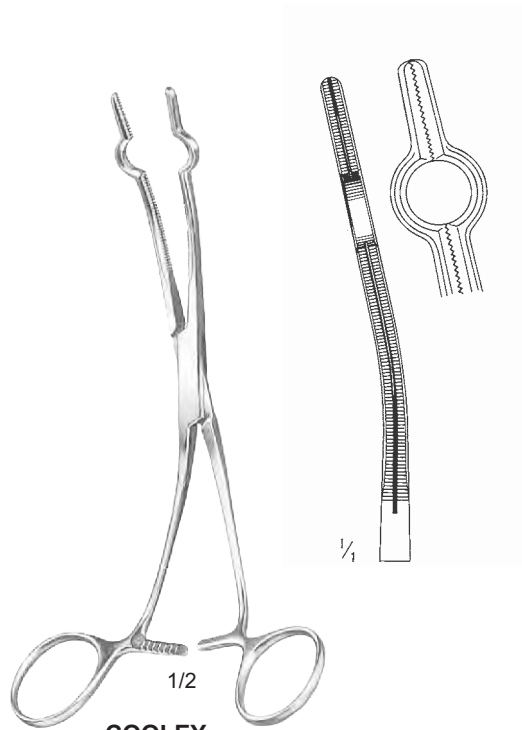

COOLEY

AJ-018074
child

AJ-018075
adult

ATRAUMA TISSUE FORCEPS

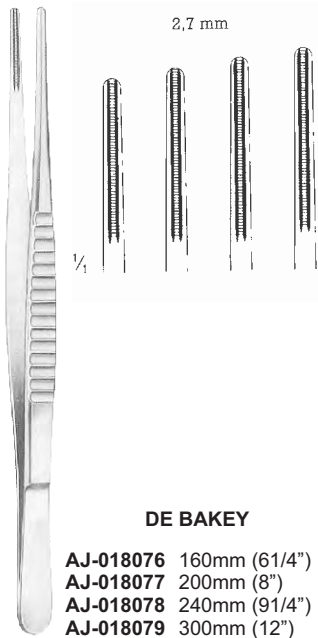

DE BAKEY

- AJ-018076** 160mm (6 1/4")
- AJ-018077** 200mm (8")
- AJ-018078** 240mm (9 1/4")
- AJ-018079** 300mm (12")

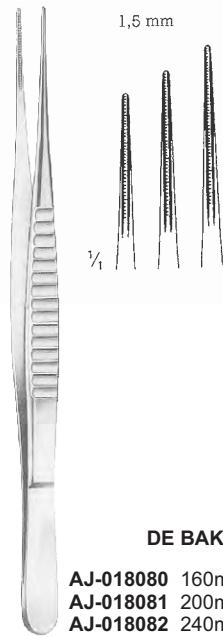

DE BAKEY

- AJ-018080** 160mm (6 1/4")
- AJ-018081** 200mm (8")
- AJ-018082** 240mm (9 1/4")

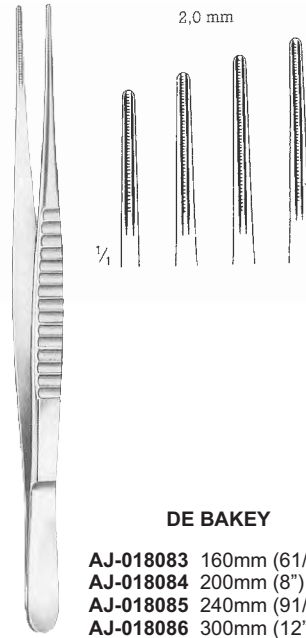

DE BAKEY

- AJ-018083** 160mm (6 1/4")
- AJ-018084** 200mm (8")
- AJ-018085** 240mm (9 1/4")
- AJ-018086** 300mm (12")

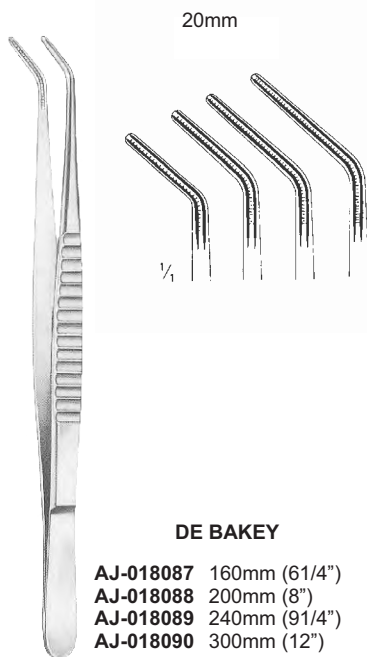

DE BAKEY

- AJ-018087** 160mm (6 1/4")
- AJ-018088** 200mm (8")
- AJ-018089** 240mm (9 1/4")
- AJ-018090** 300mm (12")

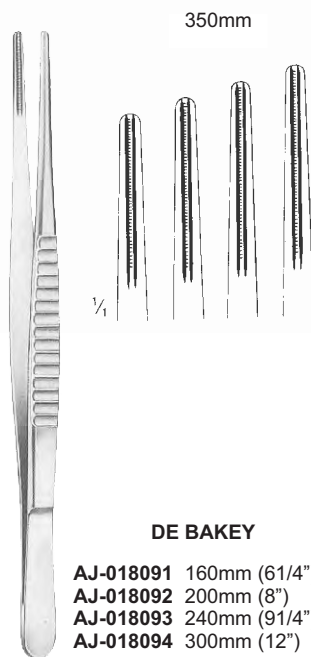

DE BAKEY

- AJ-018091** 160mm (6 1/4")
- AJ-018092** 200mm (8")
- AJ-018093** 240mm (9 1/4")
- AJ-018094** 300mm (12")



COOLEY

- AJ-018095** 160mm (6 1/4")
- AJ-018096** 200mm (8")







ATRAUMA BULLDOG CLAMPS



1/1





DEBAKEY BULLDOG CLAMPS

- 
 1/1
AJ-018097
 75mm (3")
- 
 1/1
AJ-018098
 85mm (3 1/2")
- 
 1/1
AJ-018099
 105mm (4 1/4")
- 
 1/1
AJ-018100
 120mm (4 3/4")



1/1

DEBAKEY BULLDOG CLAMPS

- 
 1/1
AJ-018101
 70mm (2 3/4")
- 
 1/1
AJ-018102
 80mm (3 1/4")
- 
 1/1
AJ-018103
 100mm (4")
- 
 1/1
AJ-018104
 115mm (4 3/4")

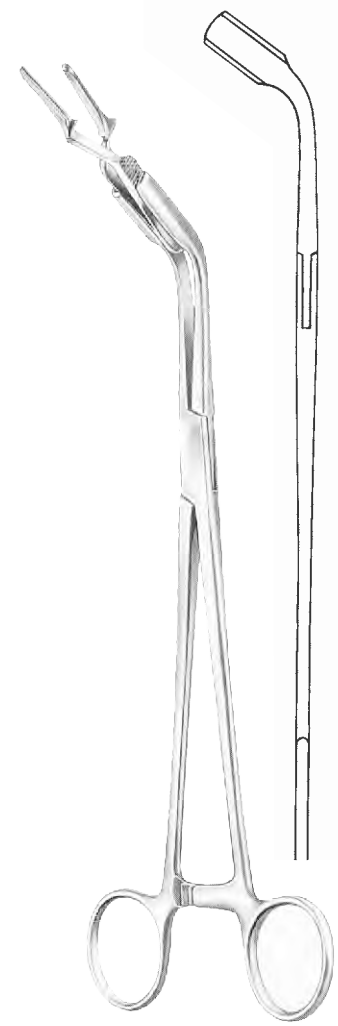

APPLYING FORCEPS
S25-18105
 230mm (9")

INSTRUMENTS

ATRAUMA CARDIOVASCULAR FORCEPS

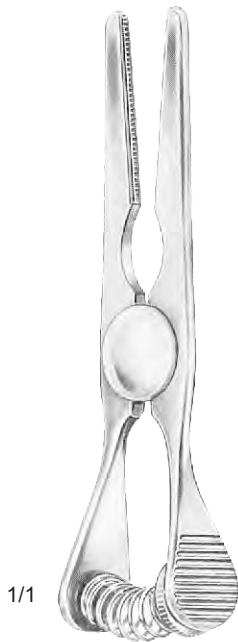

1/1

GLOVER



1/1

AJ-018106
70mm (23/4")



1/1

AJ-018107
80mm (31/4")



1/1

AJ-018108
90mm (31/2")



1/1

AJ-018109
110mm (41/2")

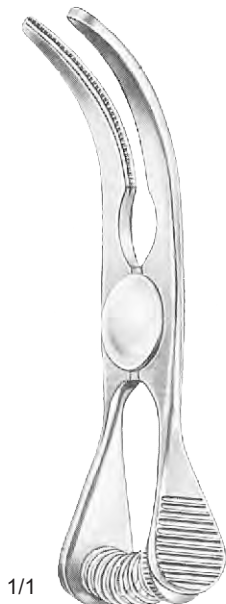

1/1

GLOVER



1/1

AJ-018110
60mm (21/2")



1/1

AJ-018111
75mm (3")



1/1

AJ-018112
85mm (31/2")



1/1

AJ-018113
105mm (41/2")



ATRAUMA CARDIOVASCULAR FORCEPS



AJ-018114
210mm (8 1/4")

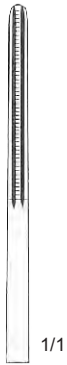

AJ-018115
220mm (8 3/4")



AJ-018116
210mm (8 1/4")

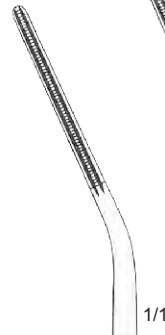

AJ-018117
220mm (8 3/4")

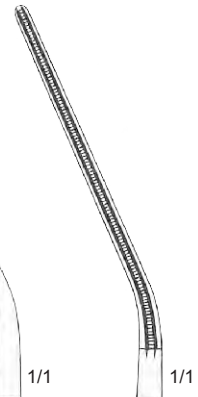

AJ-018118
210mm (8 1/4")



AJ-018119
220mm (8 3/4")



ATRAUMA CARDIOVASCULAR FORCEPS



AJ-018120
220mm (83/4")

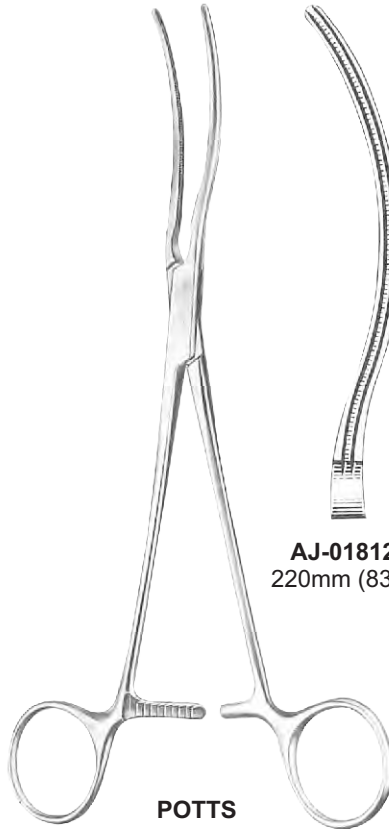

AJ-018121
220mm (83/4")



AJ-018122
190mm (71/2")



AJ-018123
230mm (9")



ATRAUMA CARDIOVASCULAR FORCEPS

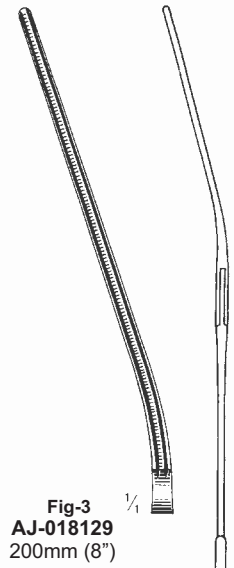
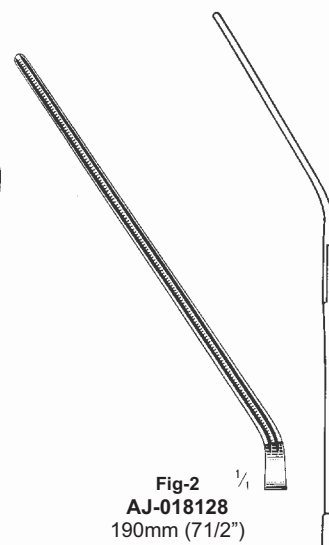
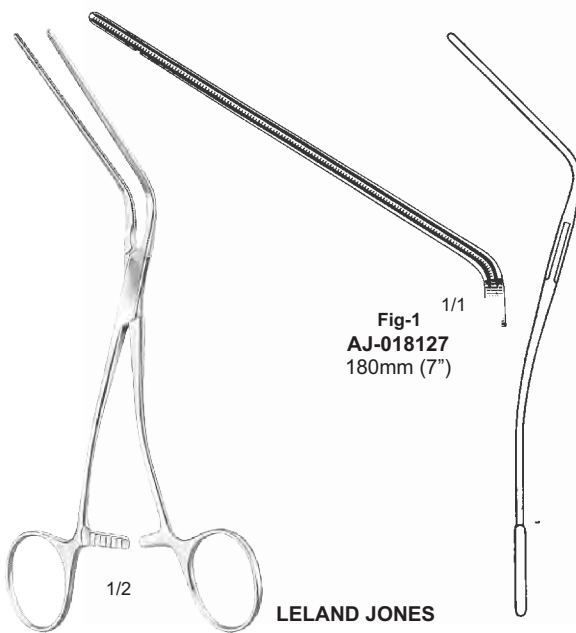
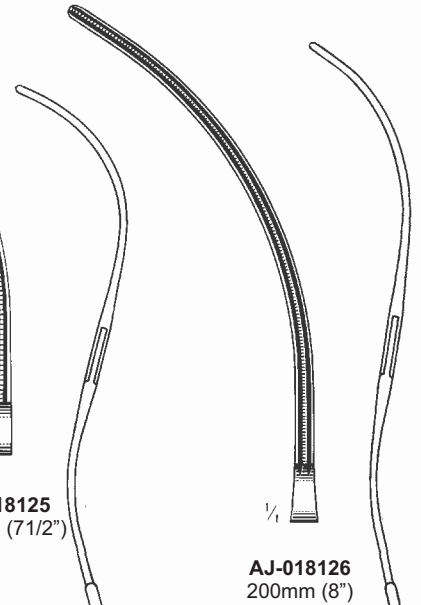
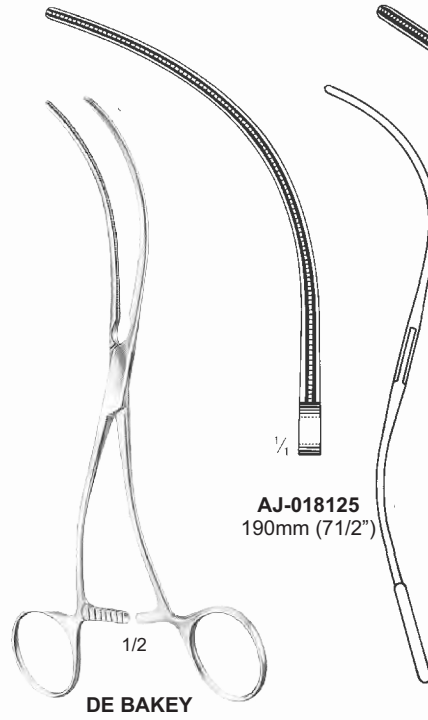
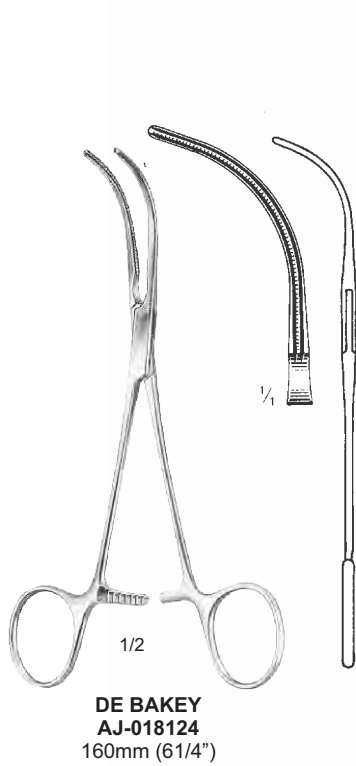

ATRAUMA CARDIOVASCULAR FORCEPS



1/2

BAINBRIDGE



1/1

AJ-018130
150mm (6")



1/1

AJ-018131
180mm (7")



1/2

BAINBRIDGE



1/1

AJ-018132
150mm (6")



1/1

AJ-018133
180mm (7")

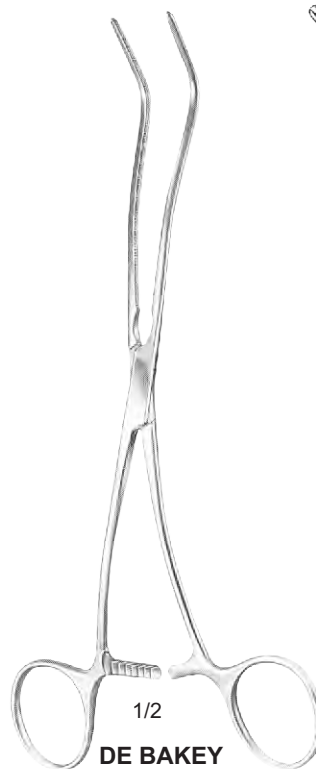

1/2

DE BAKEY
AJ-018134
200mm (8")



1/1



ATRAUMA CARDIOVASCULAR FORCEPS



1/2

ANEURYSM CLAMP

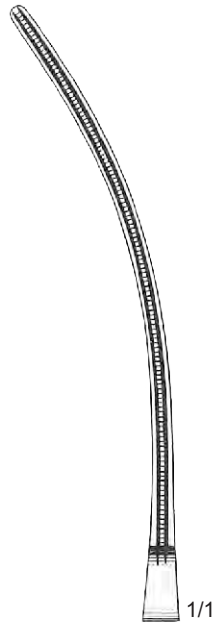

1/1

AJ-018135
260mm (10 1/4")

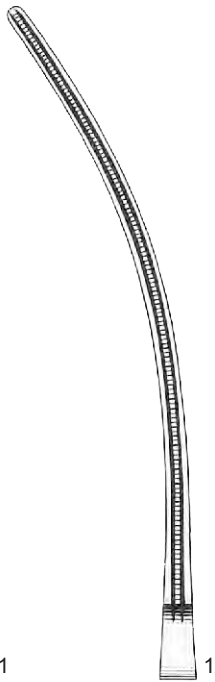

1/1

AJ-018136
270mm (10 1/2")

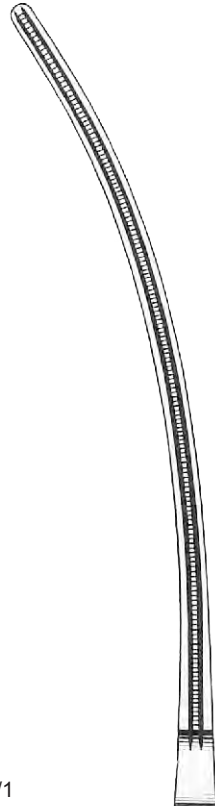

1/1

AJ-018137
310mm (12 1/4")

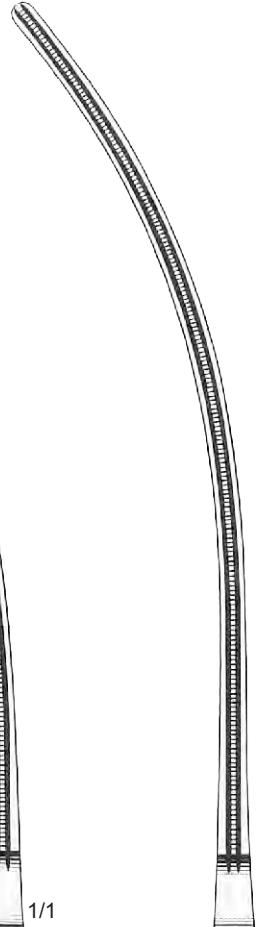

1/1

AJ-018138
330mm (13")

ATRAUMA CARDIOVASCULAR FORCEPS



DE BAKEY
AJ-018139
280mm (11")

DE BAKEY
AJ-018140
300mm (11 3/4")



ATRAUMA CARDIOVASCULAR FORCEPS



1/2
DE BAKEY
AJ-018141
27cm (10 1/2")

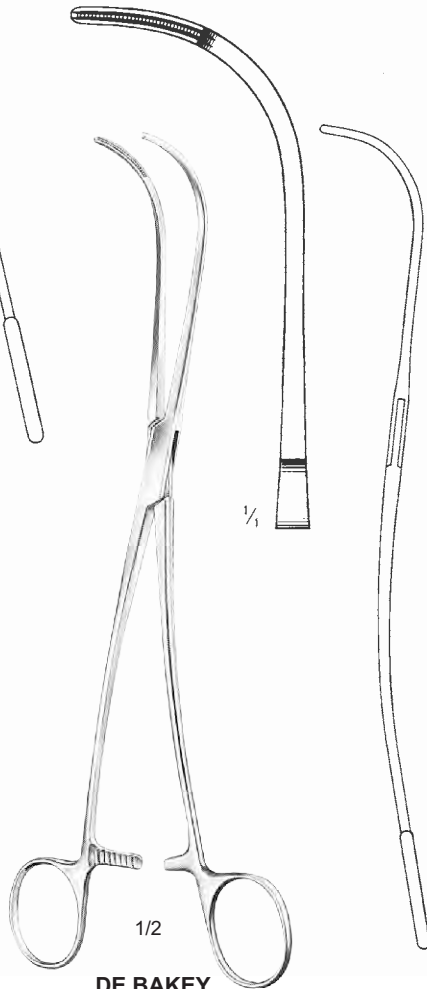
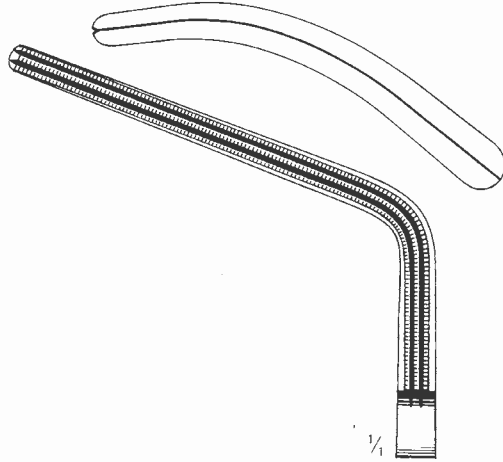

1/2
DE BAKEY
AJ-018142
240mm (9 1/2")

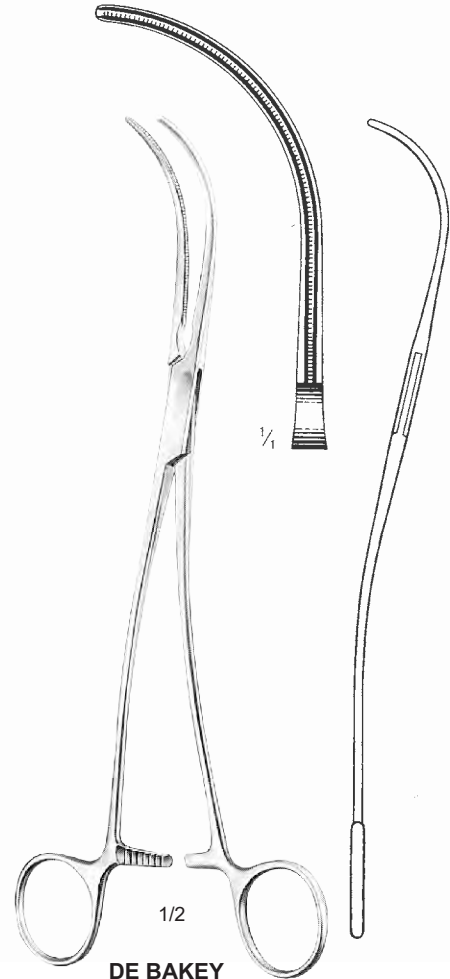

1/2
DE BAKEY
AJ-018143
240mm (9 1/2")

ATRAUMA CARDIOVASCULAR FORCEPS



DE BAKEY
AJ-018144
260mm (10")



DE BEKAY
AJ-018145
250mm (10")



ATRAUMA CARDIOVASCULAR FORCEPS

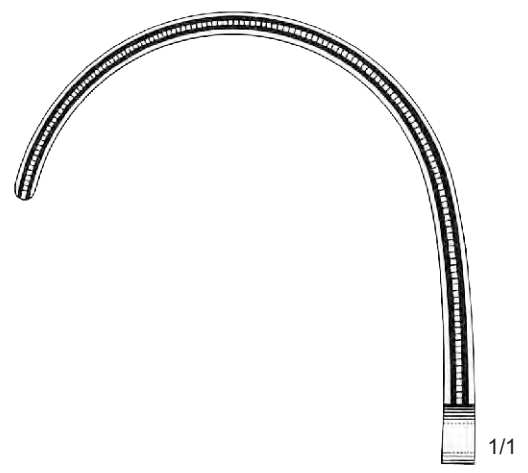
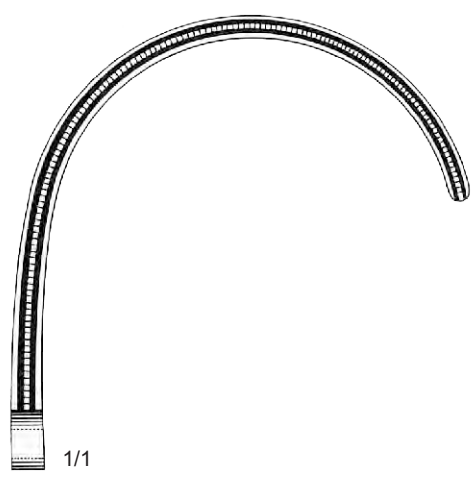

1/2
**WEBER
AJ-018146**
260mm (10 1/4")
Left



1/2
**WEBER
AJ-018147**
260mm (10 1/4")
Right

INSTRUMENTS

ATRAUMA CARDIOVASCULAR FORCEPS

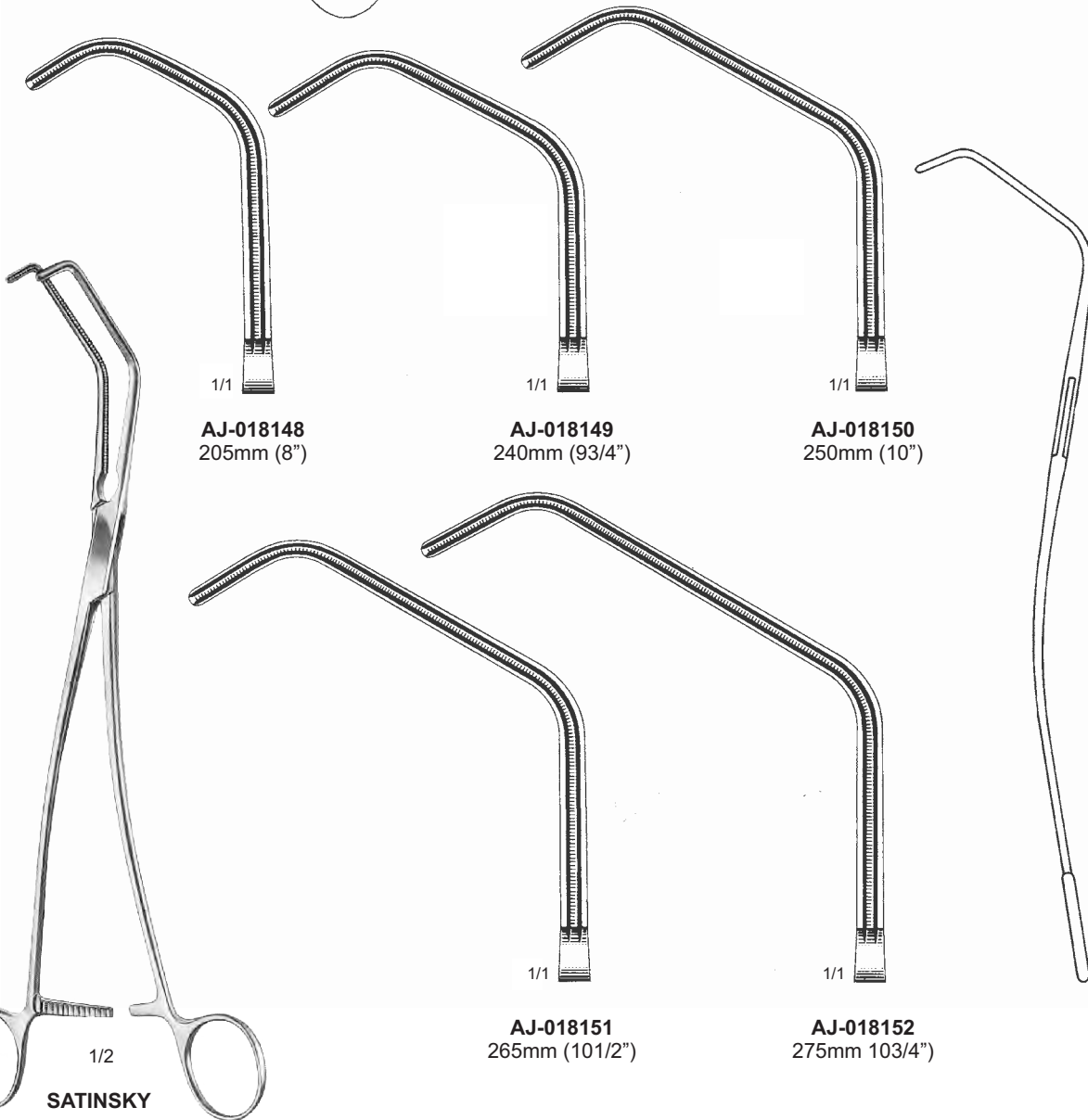
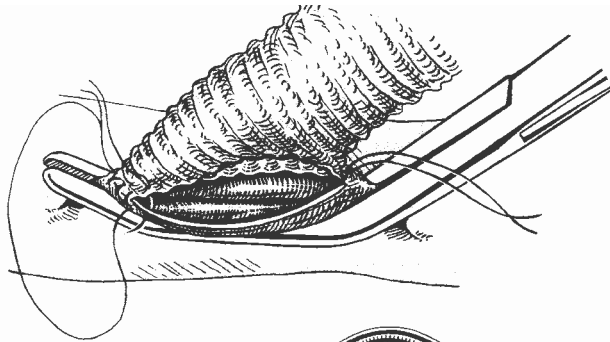

1/1
AJ-018148
205mm (8")

1/1
AJ-018149
240mm (93/4")

1/1
AJ-018150
250mm (10")

1/1
AJ-018151
265mm (101/2")

1/1
AJ-018152
275mm (103/4")



1/2
SATINSKY



ATRAUMA CARDIOVASCULAR FORCEPS



1/2
HARKEN

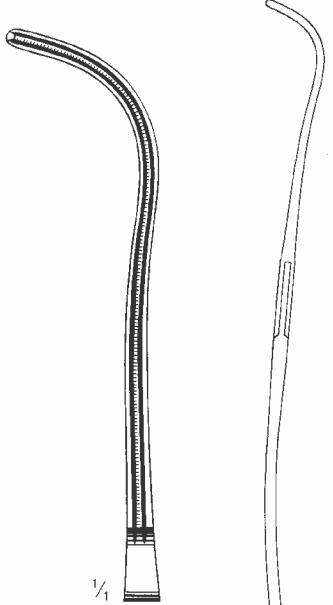

1/4
AJ-018153
240mm (9 1/2")

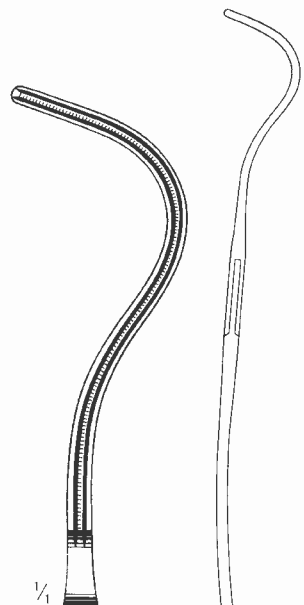

1/4
AJ-018154
240mm (9 1/2")

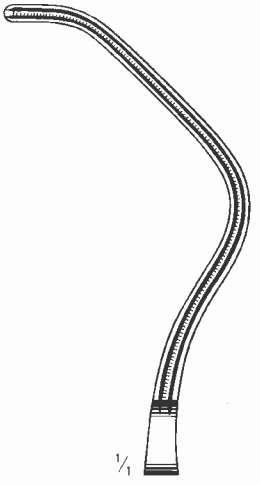

1/4
AJ-018155
240mm (9 1/2")



1/4
AJ-018156
240mm (9 1/2")

ATRAUMA CARDIOVASCULAR FORCEPS

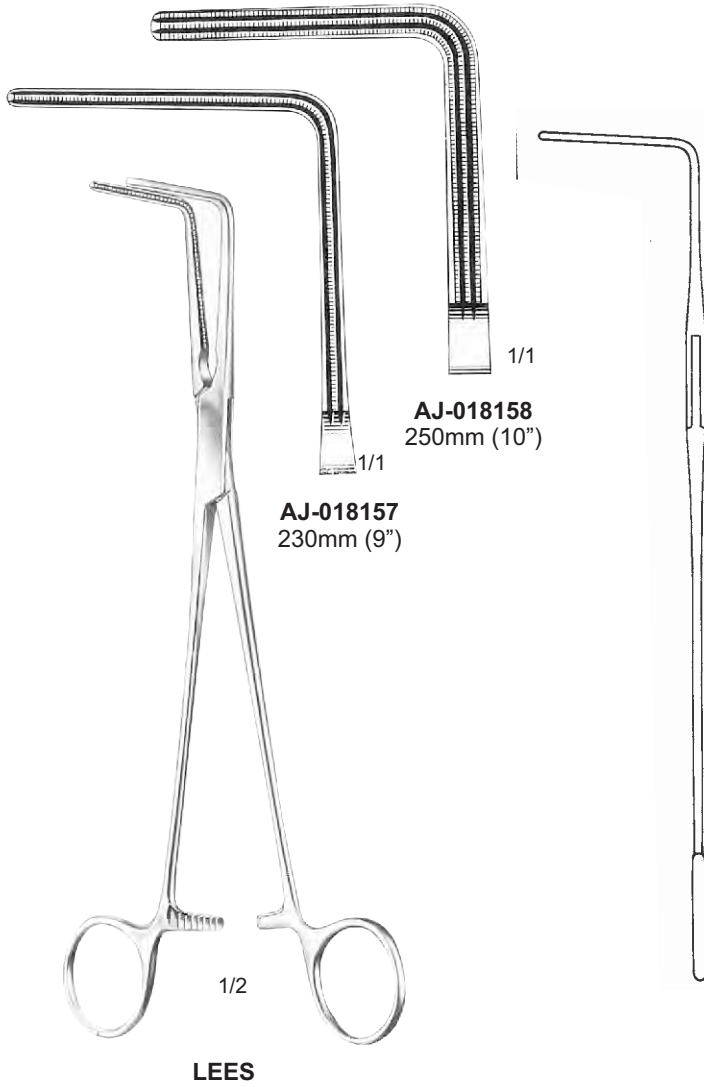

AJ-018158
250mm (10")

AJ-018157
230mm (9")

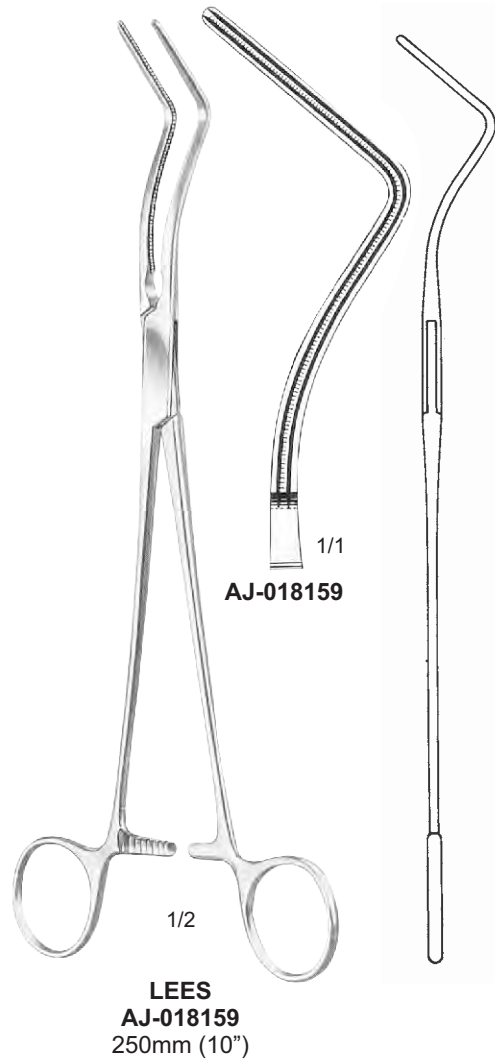

LEES
AJ-018159
250mm (10")



ATRAUMA CARDIOVASCULAR FORCEPS



1/2

LAMBERT - KAY

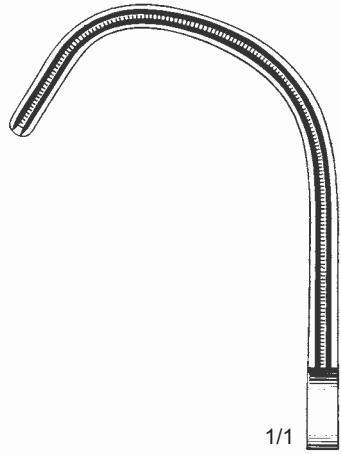

1/1

AJ-018160

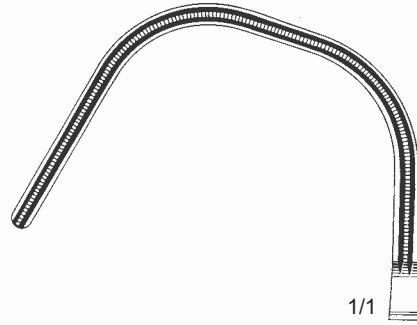

1/1

AJ-018161

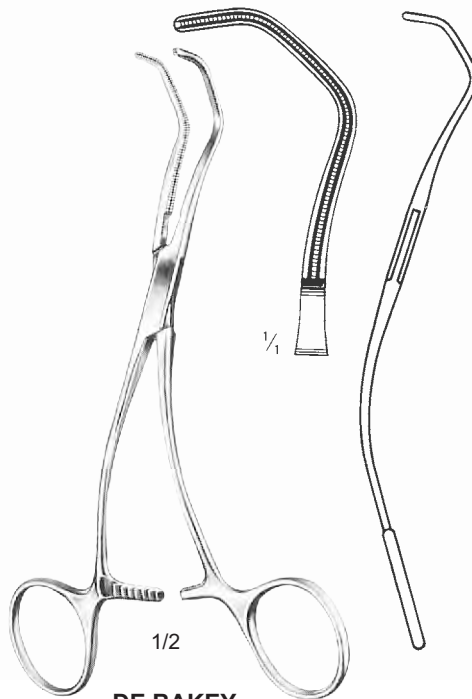
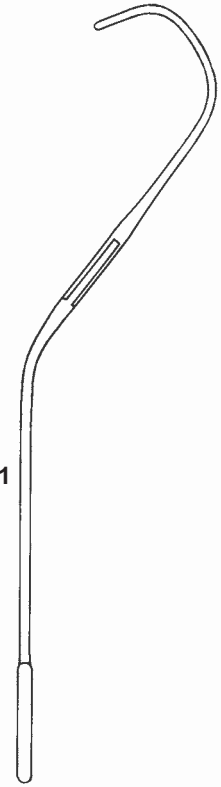

1/2

DE BAKEY
AJ-018162
170mm (63/4")

ATRAUMA CARDIOVASCULAR FORCEPS

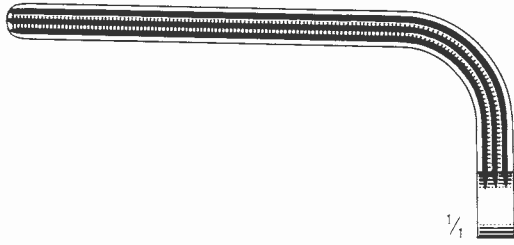

AJ-018163
180mm (7")

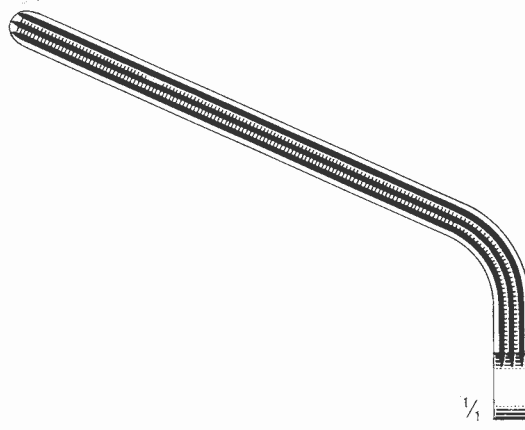

AJ-018164
200mm (8")

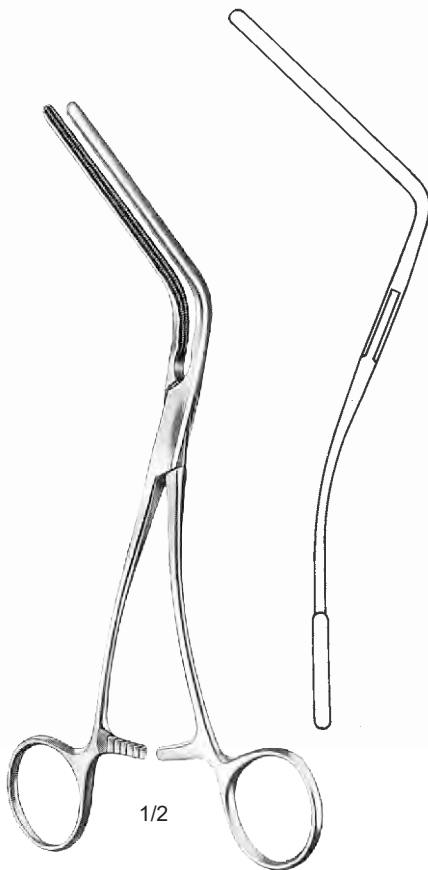

MORRIS DE BAKEY

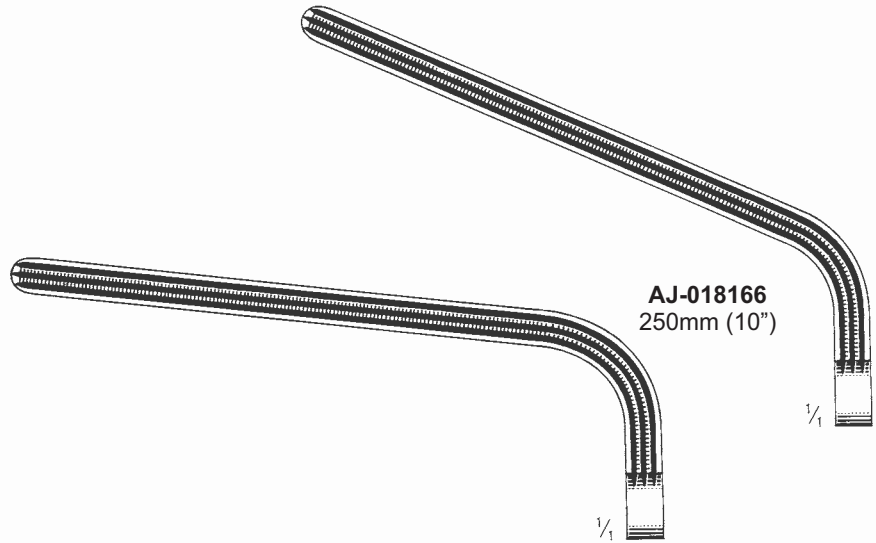

AJ-018165
230mm (9")

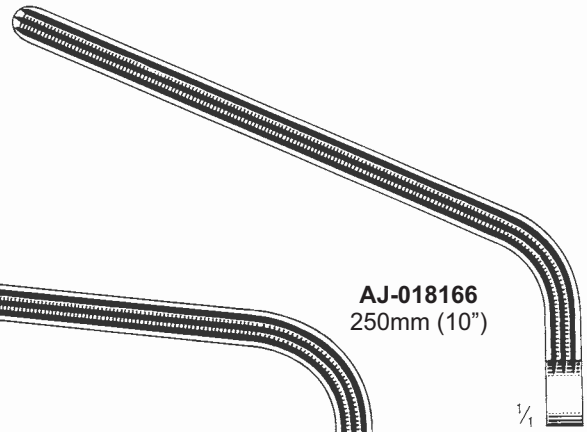

AJ-018166
250mm (10")



ATRAUMA CARDIOVASCULAR FORCEPS



DE BAKEY BAHNSON

1/2

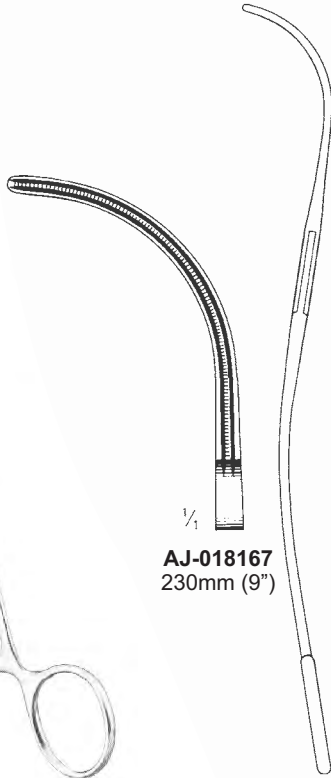

1/4

AJ-018167
230mm (9")

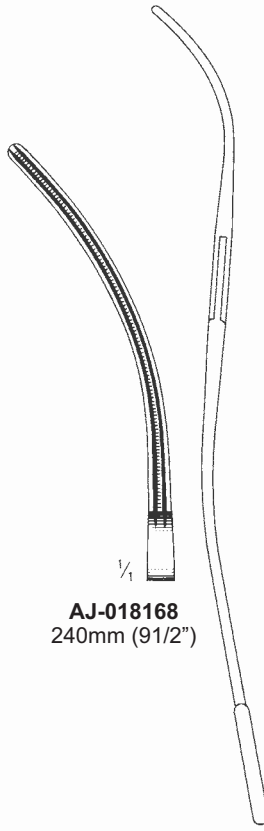

1/4

AJ-018168
240mm (9 1/2")

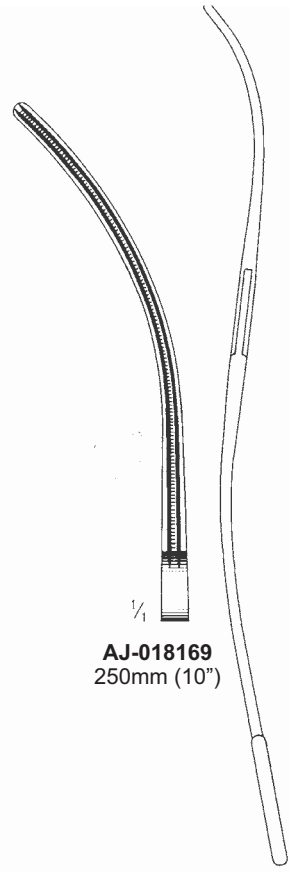

1/4

AJ-018169
250mm (10")

ATRAUMA CARDIOVASCULAR FORCEPS



AJ-018170
215mm (8 1/2")



AJ-018171
230mm (9")



AJ-018172
270mm (10 1/2")

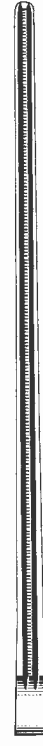

AJ-018173
315mm (12 1/2")



AJ-018174
215mm (8 1/2")



AJ-018175
230mm (9")



AJ-018176
270mm (10 1/2")



AJ-018177
315mm (12 1/2")



ATRAUMA CARDIOVASCULAR FORCEPS

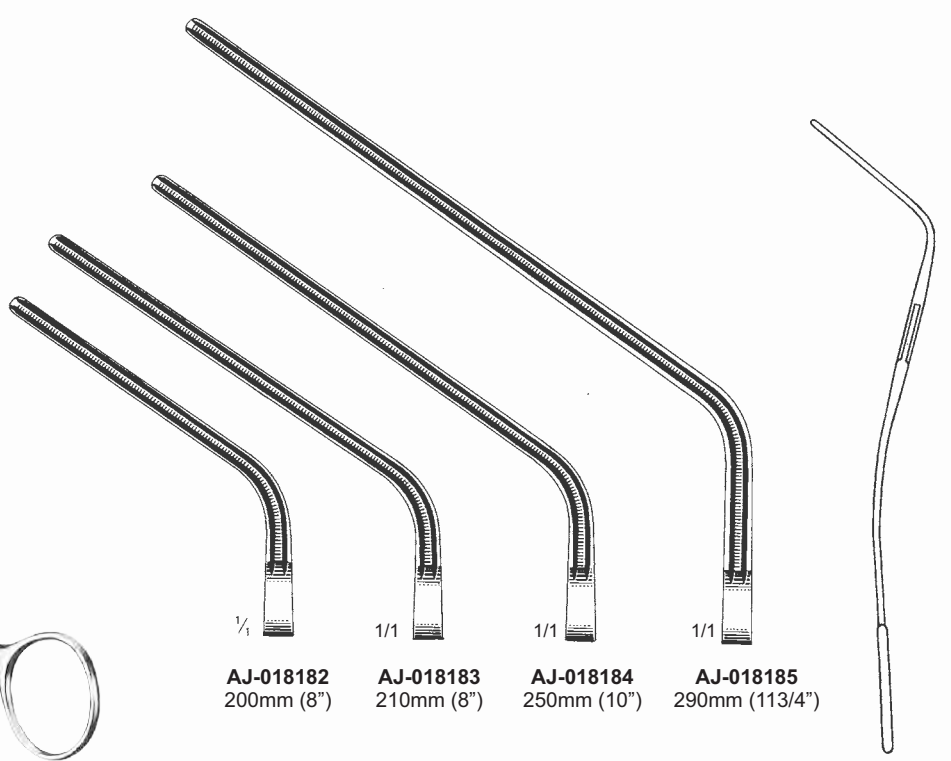
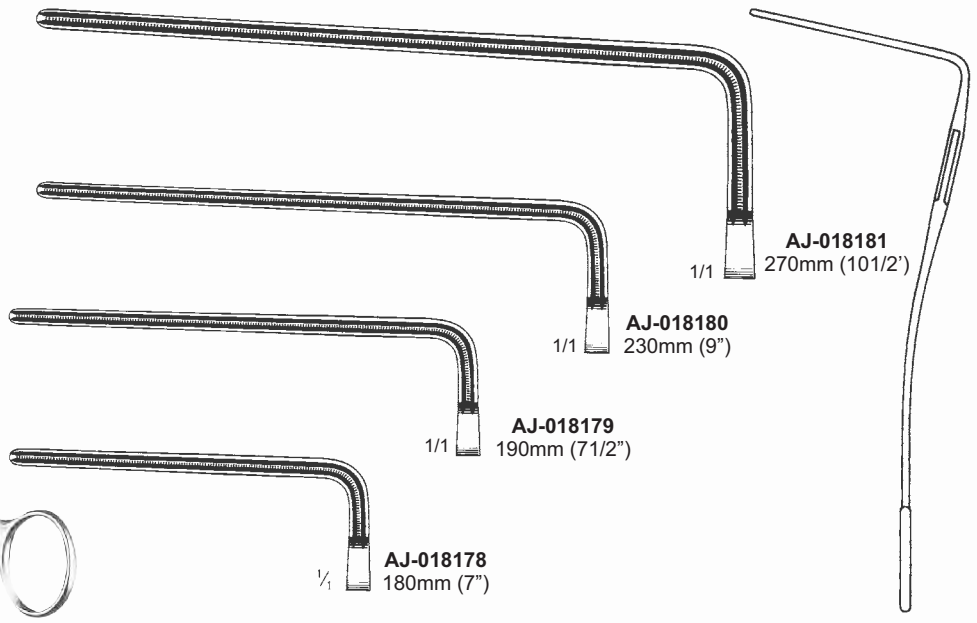

INSTRUMENTS

ATRAUMA HEMOSTATIC FORCEPS

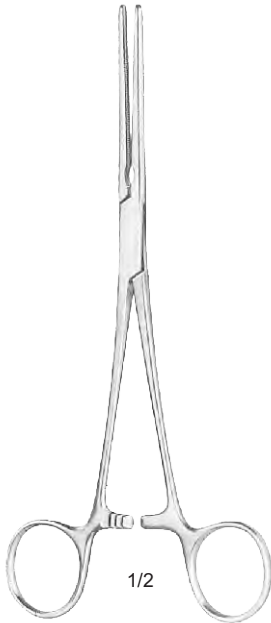

DE BAKEY PEAN

DE - BAKEY PEAN
AJ-018186
120mm (4 3/4")

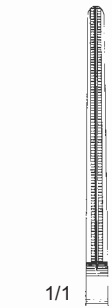

AJ-018187
140mm (5 1/2")

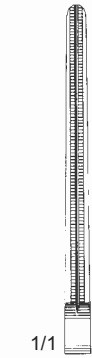

AJ-018188
160mm (6 1/4")

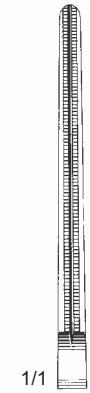

AJ-018189
180mm (7")



AJ-018190
200mm (8")

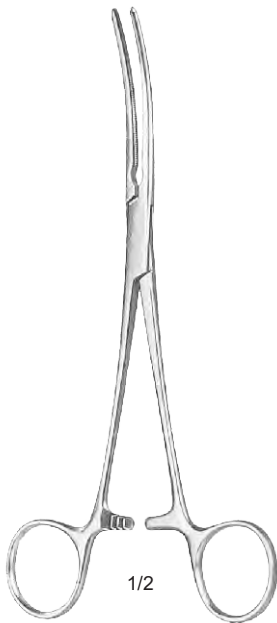

DE BAKEY PEAN

DE - BAKEY PEAN
AJ-018191
120mm (4 3/4")

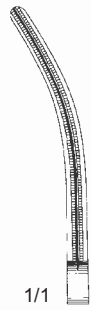

AJ-018192
140mm (5 1/2")

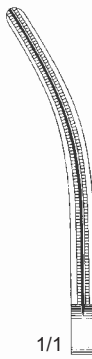

AJ-018193
160mm (6 1/4")



AJ-018194
180mm (7")

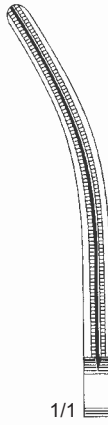

AJ-018195
200mm (8")



ATRAUMA CARDIOVASCULAR FORCEPS

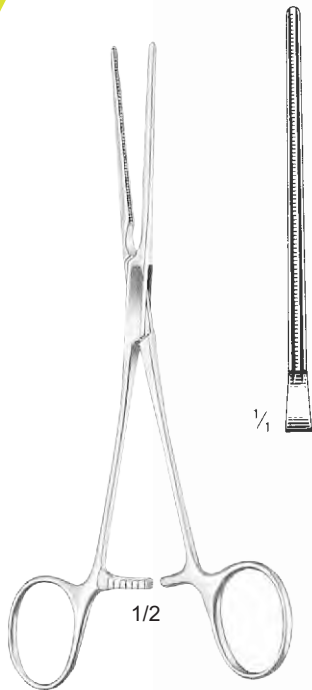

DE BAKEY
AJ-018196
170mm (6 1/4")

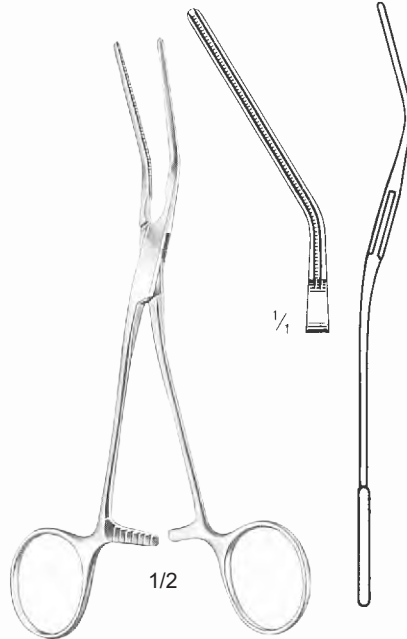

DE BAKEY
AJ-018197
160mm (6")



DE BAKEY
AJ-018198
150mm (6")

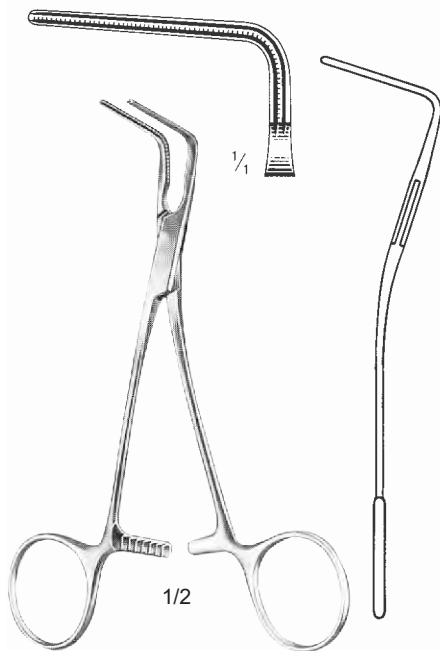

DE BAKEY
AJ-018199
150mm (6")

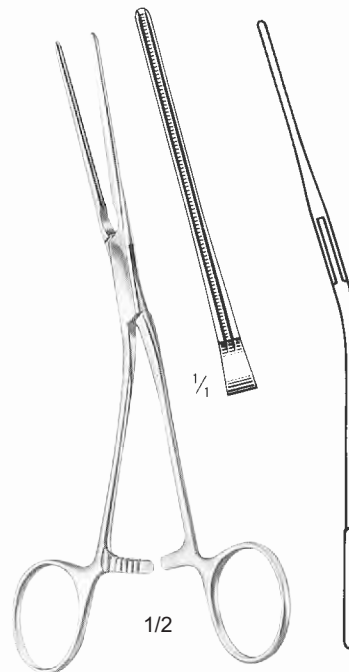

DE BAKEY
AJ-018200
170mm (6 1/4")

ATRAUMA CARDIOVASCULAR FORCEPS

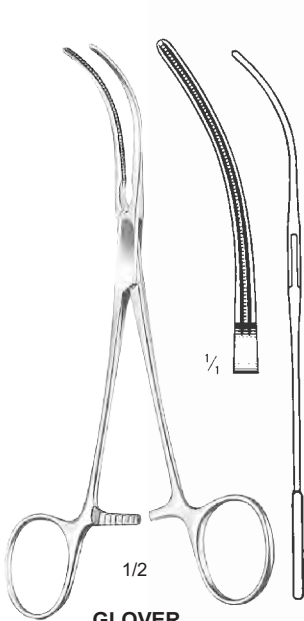

GLOVER
AJ-018201
170mm (63/4")

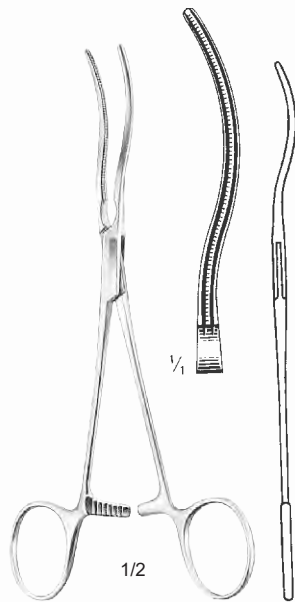

AJ-018202
170mm (63/4")

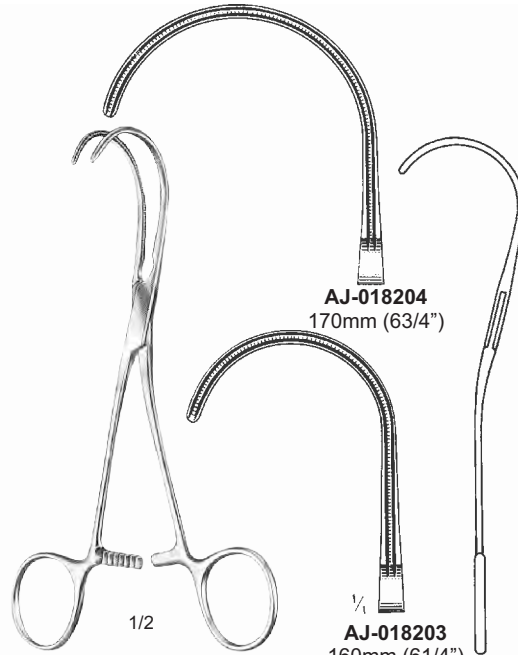

AJ-018204
170mm (63/4")

AJ-018203
160mm (61/4")

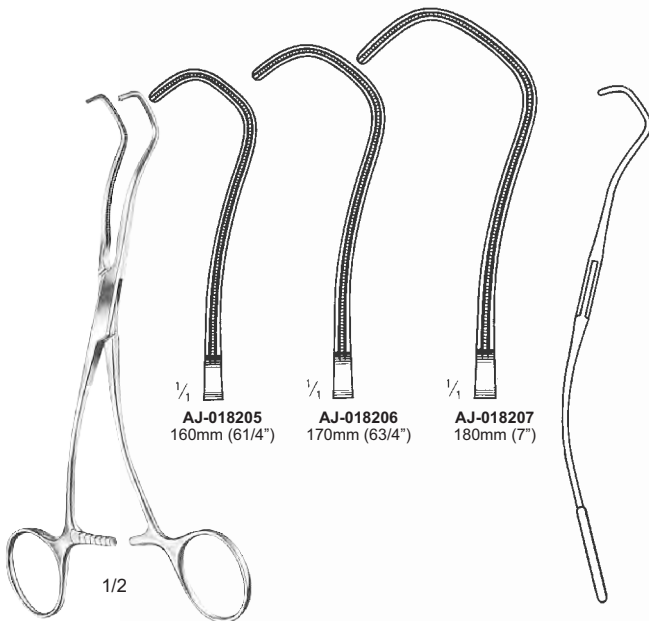

DERRA

AJ-018205
160mm (61/4")

AJ-018206
170mm (63/4")

AJ-018207
180mm (7")

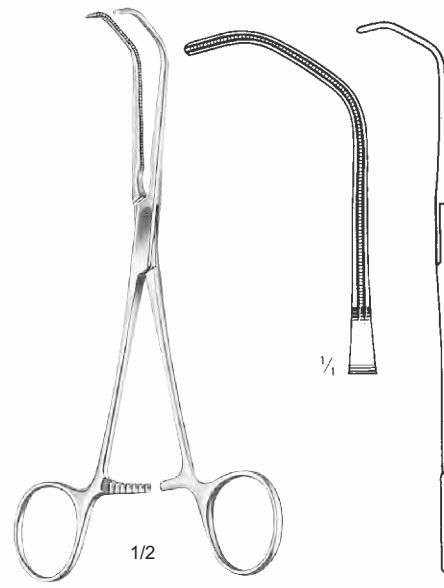

BECK
AJ-018208
170mm (63/4")



ATRAUMA CARDIOVASCULAR FORCEPS



DE BAKEY
AJ-018209
100mm (4")

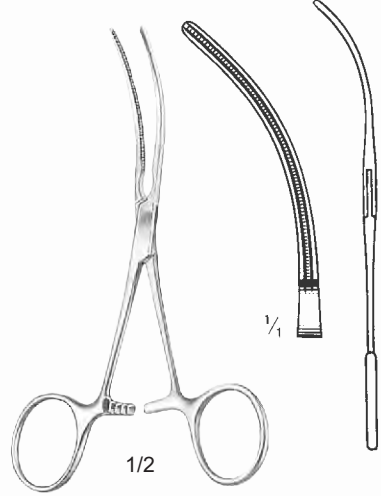

DE BAKEY
AJ-018210
110mm (4 1/4")

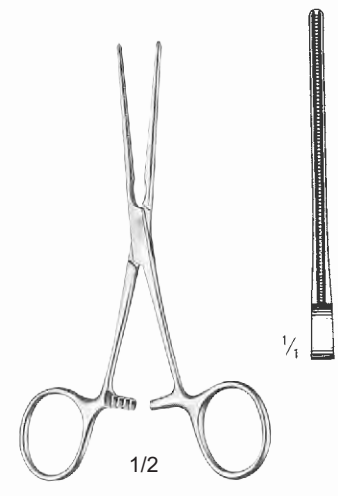

DE BAKEY
AJ-018211
120mm (4 3/4")

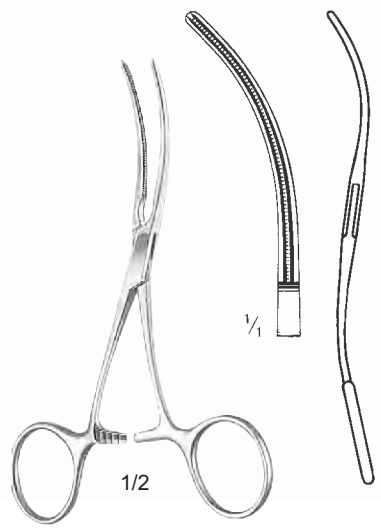

DE BAKEY
AJ-018212
120mm (4 3/4")

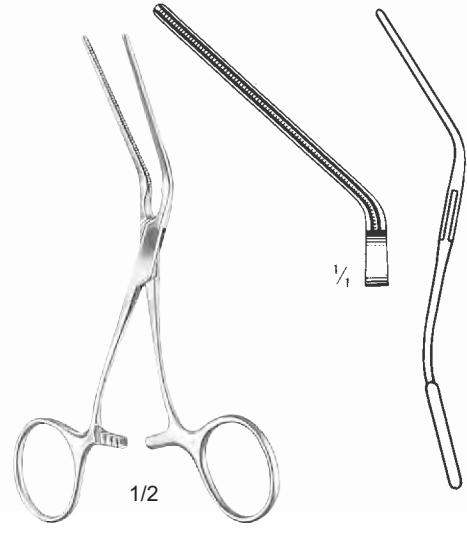

DE BAKEY
AJ-018213
130mm (5 1/4")

INSTRUMENTS

ATRAUMA CARDIOVASCULAR FORCEPS

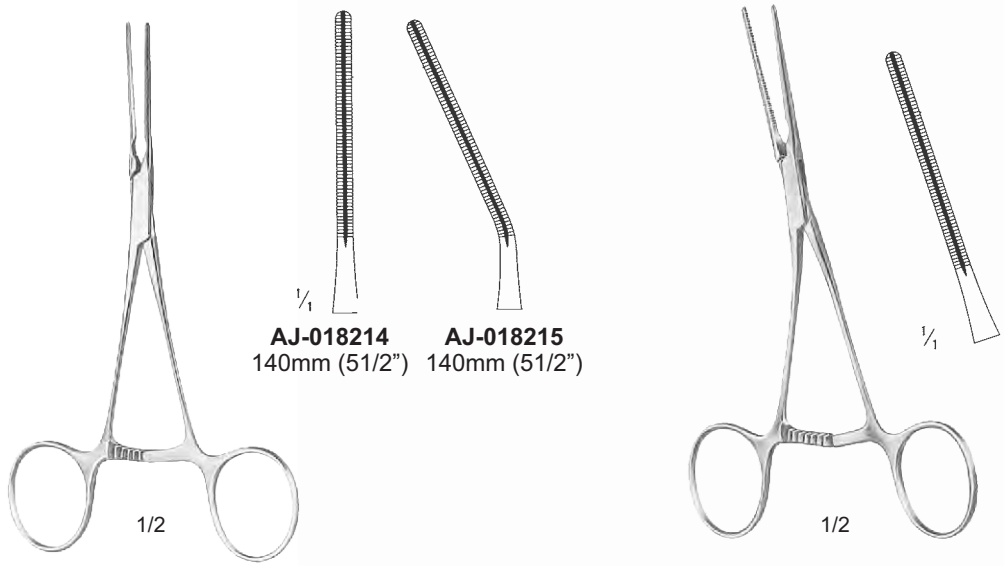

AJ-018214 140mm (5 1/2")
AJ-018215 140mm (5 1/2")

COOLEY
Very delicate pattern

COOLEY
Very delicate pattern
AJ-018216
140mm (5 1/2")

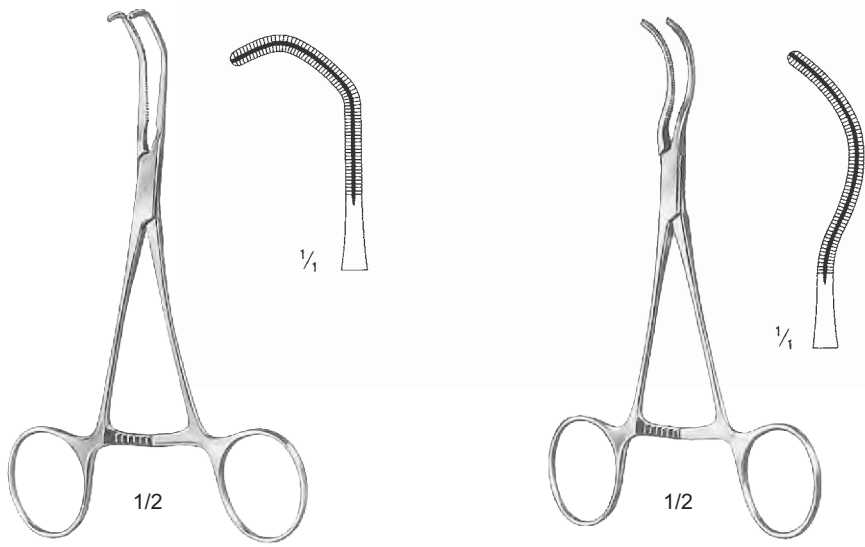

COOLEY
Very delicate pattern
AJ-018217
140mm (5 1/2")

COOLEY
Very delicate pattern
AJ-018218
140mm (5 1/2")



ATRAUMA CARDIOVASCULAR FORCEPS

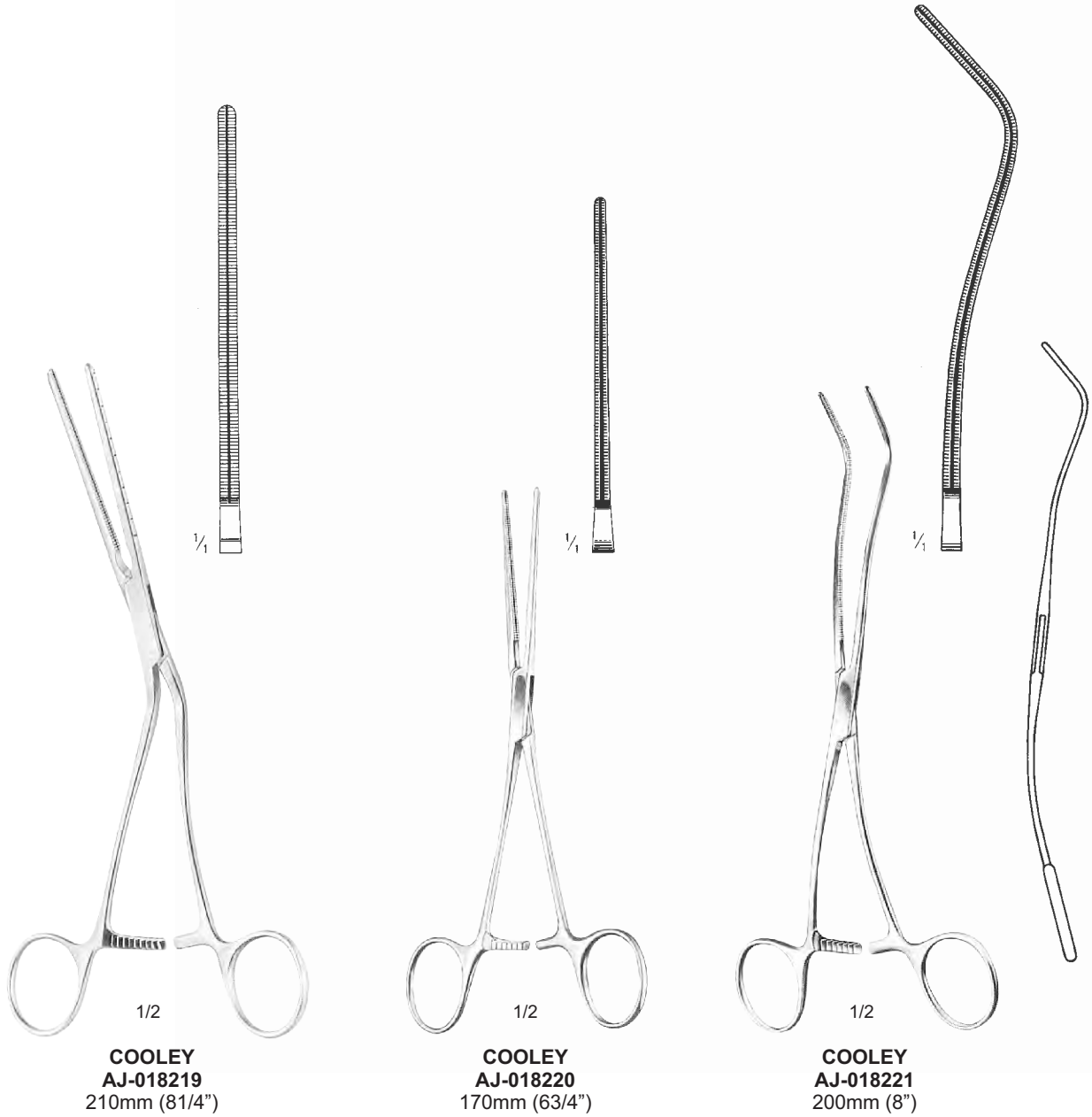

COOLEY
AJ-018219
210mm (8 1/4")

COOLEY
AJ-018220
170mm (6 3/4")

COOLEY
AJ-018221
200mm (8")

ATRAUMA CARDIOVASCULAR FORCEPS

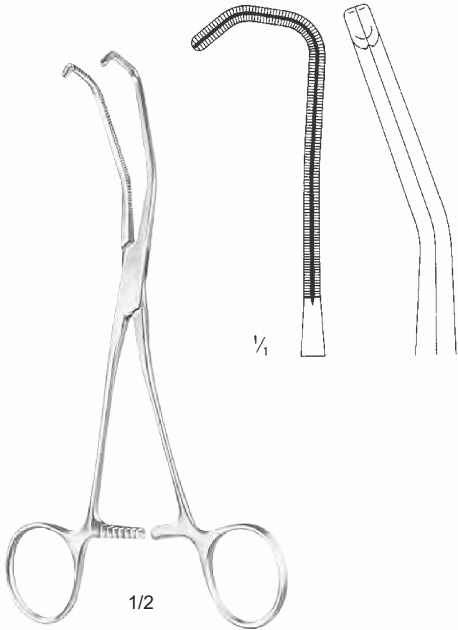

**COOLEY
AJ-018222**
170mm (63/4")

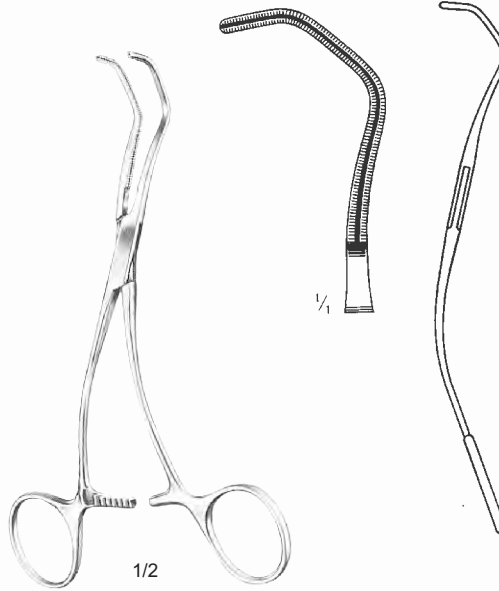

**COOLEY
AJ-018223**
160mm (61/4")

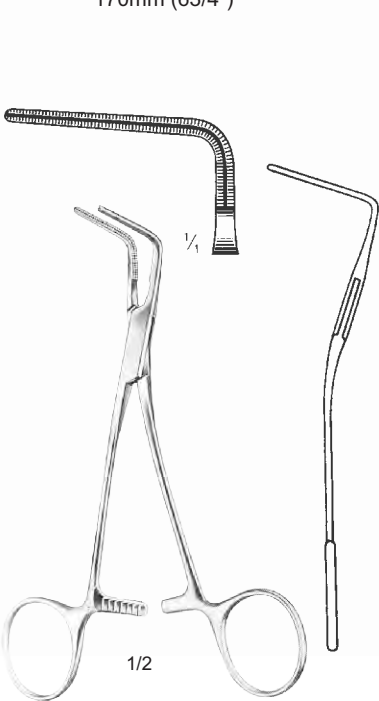

**COOLEY
AJ-018224**
150mm (6")



**COOLEY
AJ-018225**
155mm (61/4")

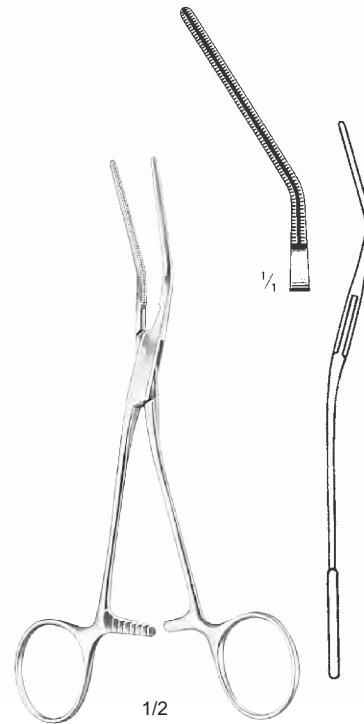

**COOLEY
AJ-018226**
170mm (63/4")



ATRAUMA CARDIOVASCULAR FORCEPS

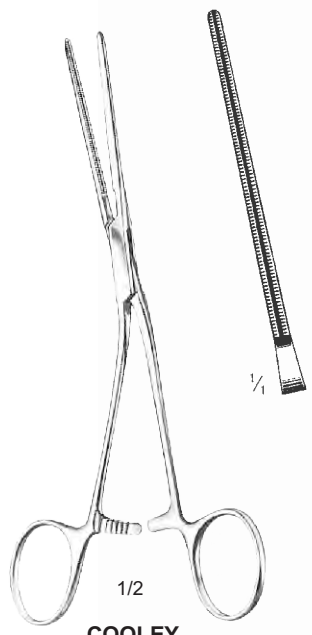

1/2
**COOLEY
AJ-018227**
170mm (63/4")

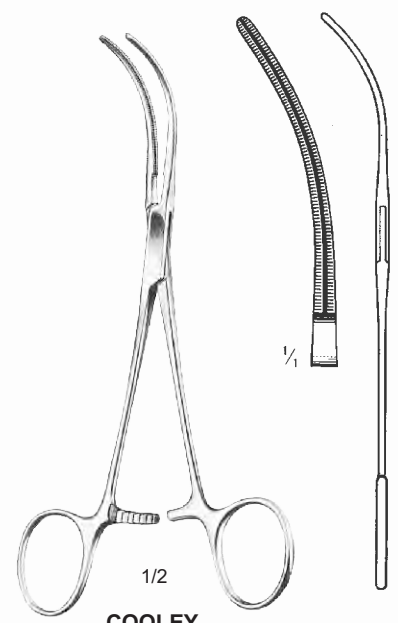

1/2
**COOLEY
AJ-018228**
170mm (63/4")

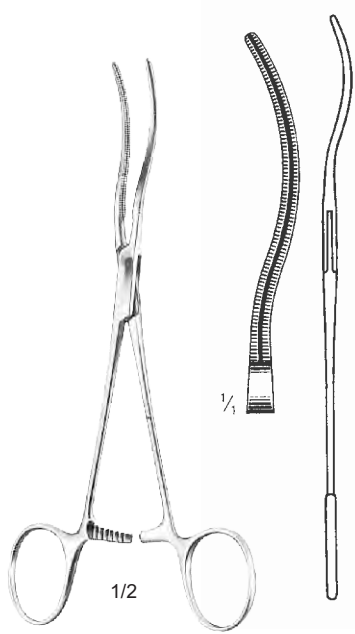

1/2
**COOLEY
AJ-018229**
170mm (63/4")

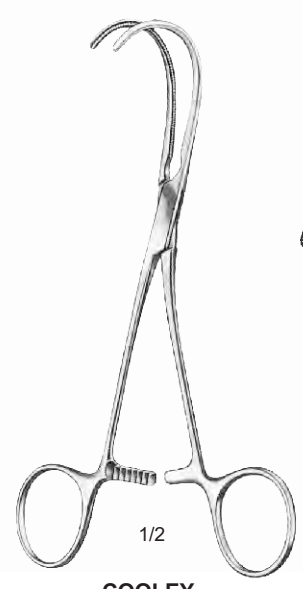

1/2
COOLEY

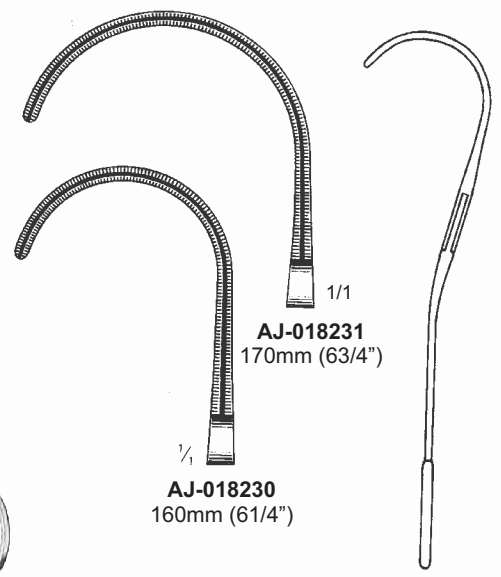

1/4
AJ-018231
170mm (63/4")
1/4
AJ-018230
160mm (61/4")

INSTRUMENTS

DILATORS

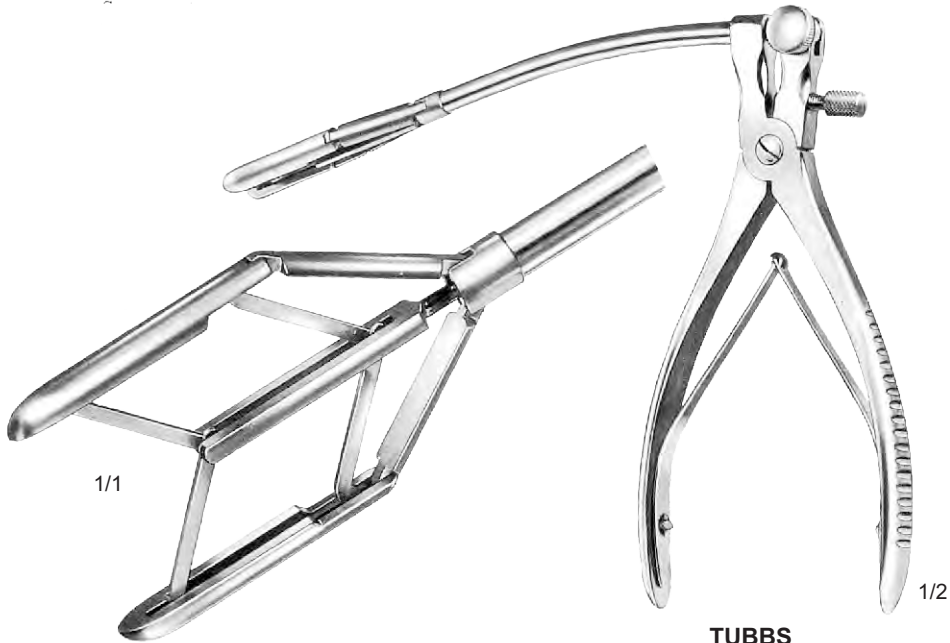

1/1

1/2

TUBBS
AJ-018232
Blade opening from 8 to 42mm

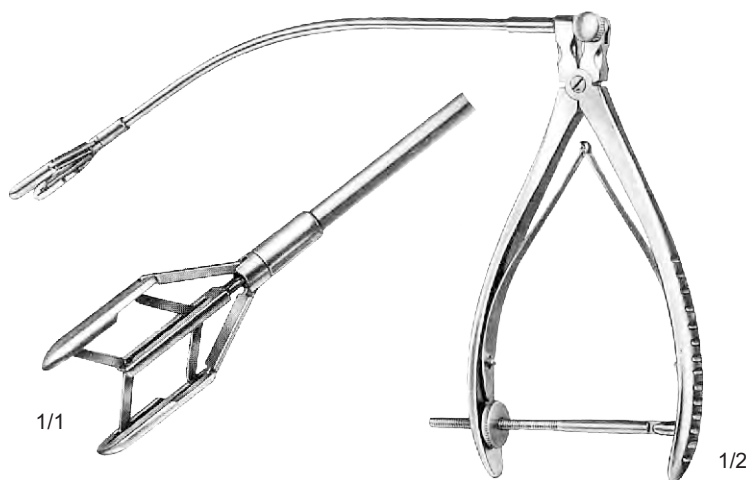

1/1

1/2

COOLEY
AJ-018233
Blade opening from 8 to 15mm



VASCULAR DILATORS

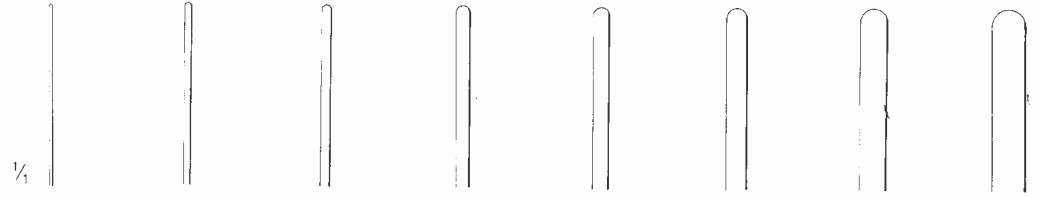

- AJ-018234
05mm Ø
- AJ-018235
10 mm Ø
- AJ-018236
15 mm Ø
- AJ-018237
20 mm Ø
- AJ-018238
25 mm Ø
- AJ-018239
30 mm Ø
- AJ-018240
40 mm Ø
- AJ-018241
50 mm Ø

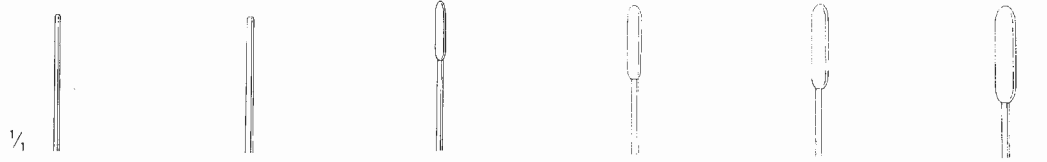

- AJ-018242
05mm Ø
- AJ-018243
10 mm Ø
- AJ-018244
15 mm Ø
- AJ-018245
20 mm Ø
- AJ-018246
25 mm Ø
- AJ-018247
30 mm Ø

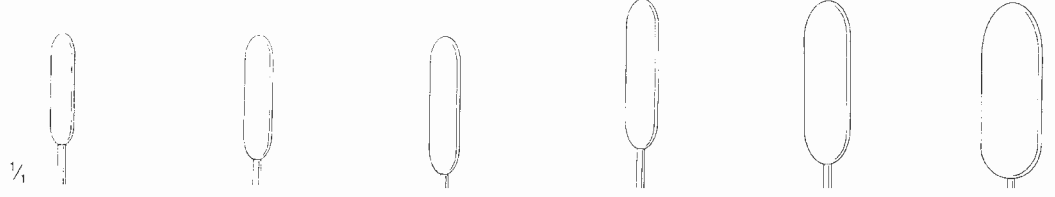

- AJ-018248
35 mm Ø
- AJ-018249
40 mm Ø
- AJ-018250
45 mm Ø
- AJ-018251
50 mm Ø
- AJ-018252
70 mm Ø
- AJ-018253
90 mm Ø

INSTRUMENTS

TUNNELING INSTRUMENT

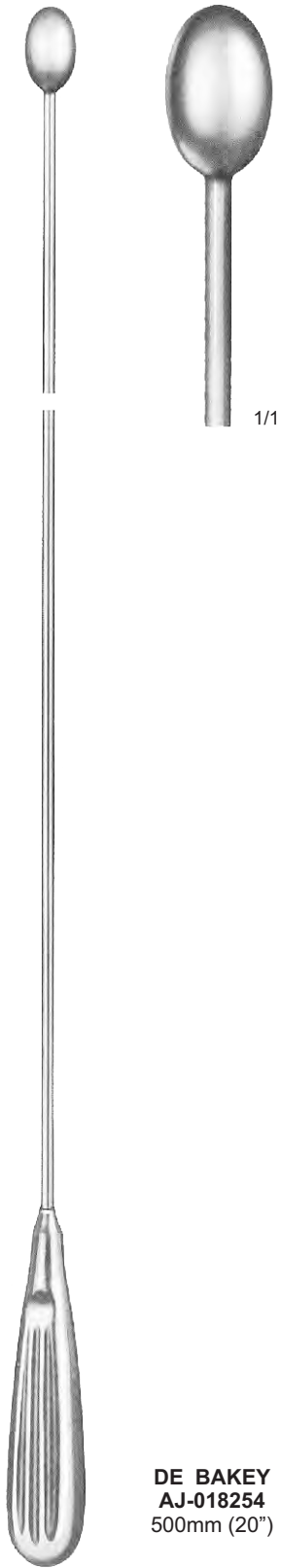

1/1

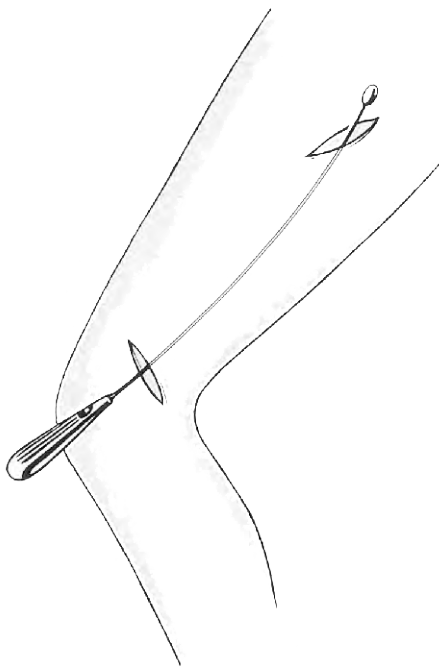

DE BAKEY
AJ-018254
500mm (20")



TUNNELING SET



AJ-018255
Complete Set



AJ-018256 6 mm **AJ-018257** 8mm **AJ-018258** 10mm **AJ-018259** 12mm



AJ-018260 **AJ-018261**

110mm x 37mm
80 mm x 32mm
80 mm x 24mm

- AJ-018255** Tunneling set complete
- AJ-018262** Universal Handle (2x)
- AJ-018263** Tunneling shaft, curved, 225mm
- AJ-018264** Tunneling shaft, straight, 225mm
- AJ-018264** Tunneling shaft, curved, 540mm
- AJ-018265** Bullet tip 6mm (2 x)
- AJ-018256** Bullet tip 8mm (2 x)
- AJ-018257** Bullet tip 10mm (2 x)
- AJ-018258** Bullet tip 12mm (2 x)
- AJ-018259** Vein tip
- AJ-018259** Luer Adaptor
- AJ-018260** Plate for tips only
- AJ-018261** Sterilizing cases 550 x 115 x 35mm

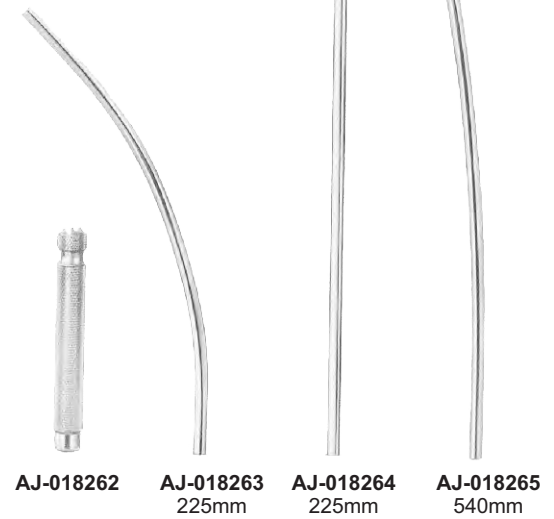

AJ-018262 **AJ-018263** 225mm **AJ-018264** 225mm **AJ-018265** 540mm

INSTRUMENTS

ENDARTERECTOMY

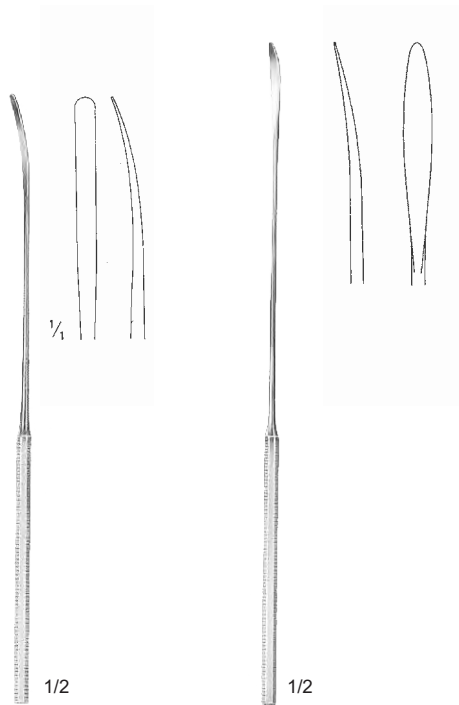

AJ-018266
185mm (7")
Blunt

AJ-018267
140mm (5 1/2")
Blunt

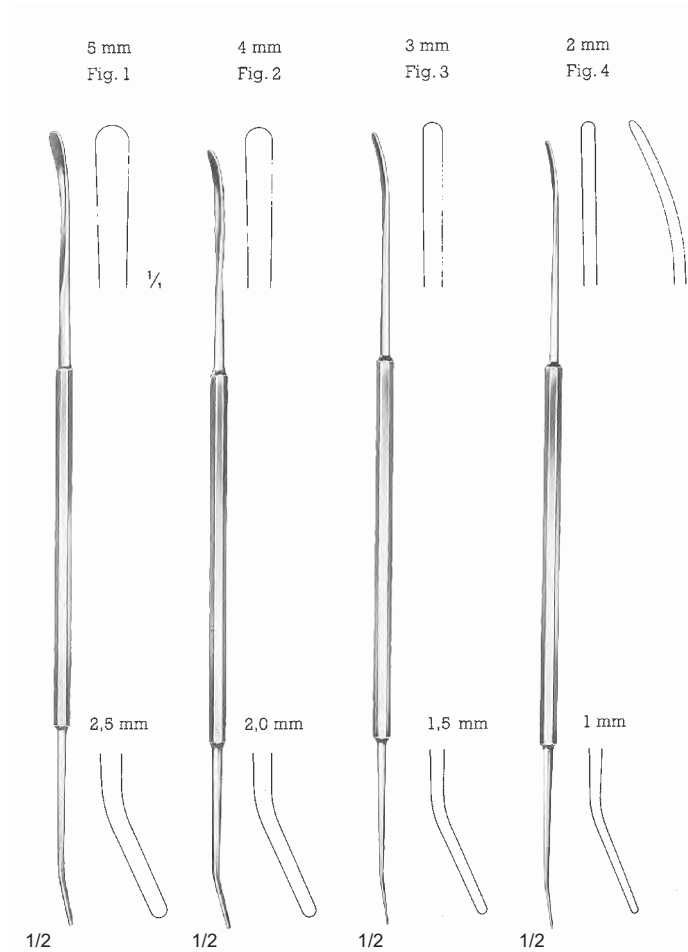

ROBB
AJ-018268
240mm (10")

ROBB
AJ-018269
240mm (10")

ROBB
AJ-018270
240mm (10")

ROBB
AJ-018271
240mm (10")



NERVE HOOKS, TOURNIQUETS



1/2

CRILE
AJ-018272
200mm (8")



1/4

1

1/4

2



1/2

RUMEL-BELMONT
AJ-018273
330mm (13")

NEONATAL & PEDIATRIC CLAMPS



Very delicate pattern

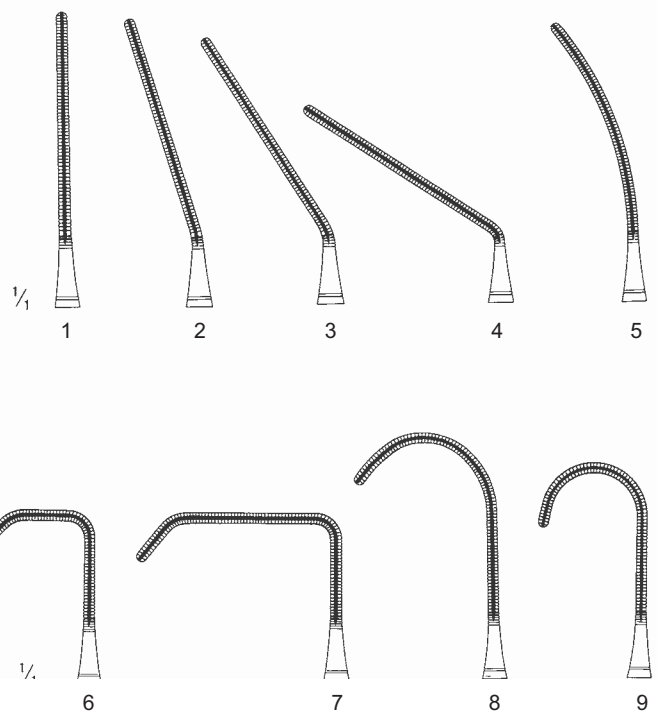

Fig	Straight
1	AJ-018274 145mm (53/4")
2	AJ-018275 145mm (53/4")
3	AJ-018276 145mm (53/4")
4	AJ-018277 135mm (51/4")
5	AJ-018278 140mm (51/2")
6	AJ-018279 135mm (51/4")
7	AJ-018280 135mm (51/4")
8	AJ-018281 140mm (53/4")
9	AJ-018282 135mm (51/4")

Fig	Angled
1	AJ-018283 145mm (53/4")
2	AJ-018284 145mm (53/4")
3	AJ-018285 145mm (53/4")
4	AJ-018286 135mm (51/4")
5	AJ-018287 140mm (51/2")
6	AJ-018288 135mm (51/4")
7	AJ-018289 135mm (51/4")
8	AJ-018290 140mm (53/4")
9	AJ-018291 135mm (51/4")

Fig	Curved
1	AJ-018292 145mm (53/4")
2	AJ-018293 145mm (53/4")
3	AJ-018294 145mm (53/4")
4	AJ-018295 135mm (51/4")
5	AJ-018296 140mm (51/2")
6	AJ-018297 135mm (51/4")
7	AJ-018298 135mm (51/4")
8	AJ-018299 140mm (53/4")
9	AJ-018300 135mm (51/4")



ATRAUMA PEDIATRIC CLAMPS

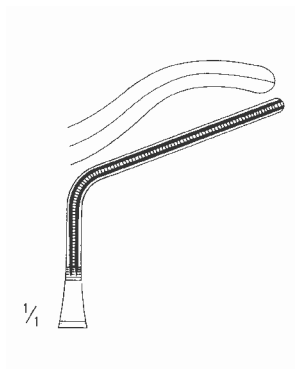
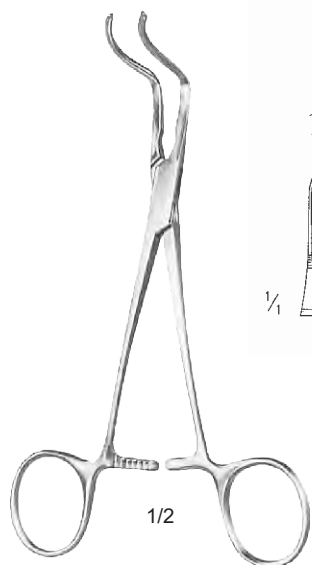

SUBRAMANIAN - MINIATURE
AJ-018301
155mm (6")

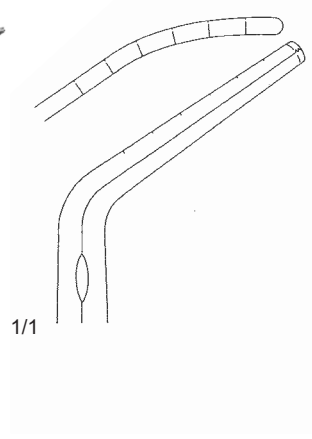

SUBRAMANIAN
AJ-018302
160mm (6 1/4")

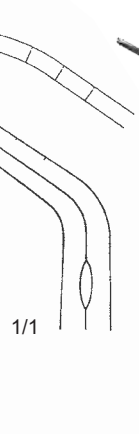
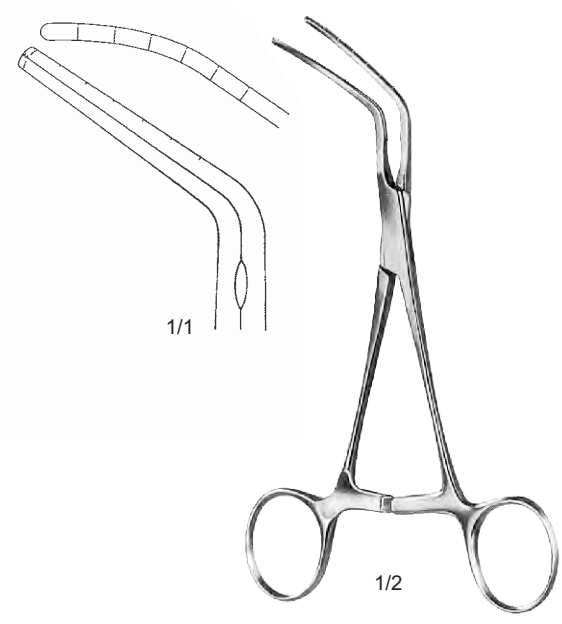

SUBRAMANIAN
AJ-018303
160mm (6 1/4")

INSTRUMENTS

ATRAUMA PEDIATRIC CLAMPS VERY DELICATE PATTERNS

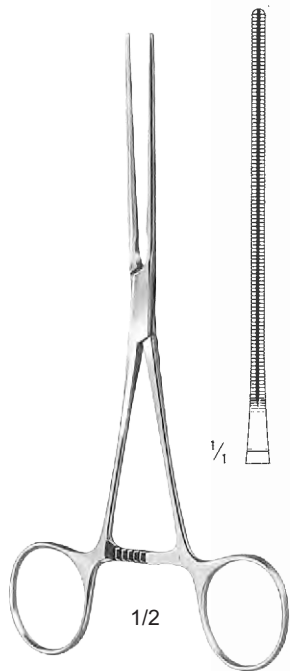

AJ-018304
165mm (6 1/2")

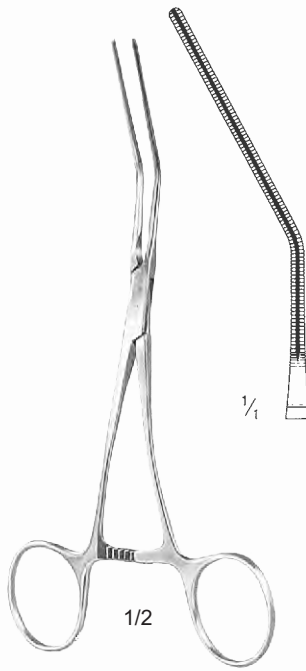

AJ-018305
160mm (6 1/4")

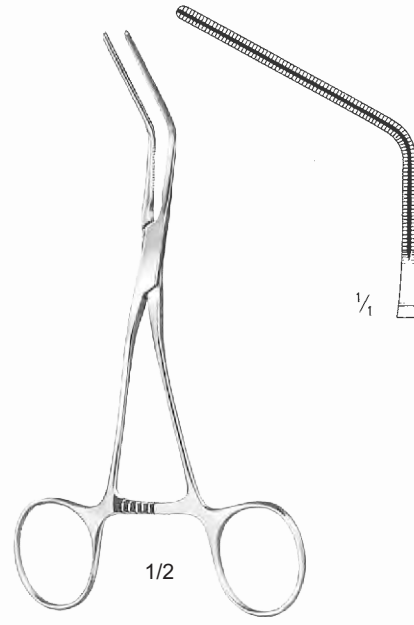

AJ-018306
150mm (6")

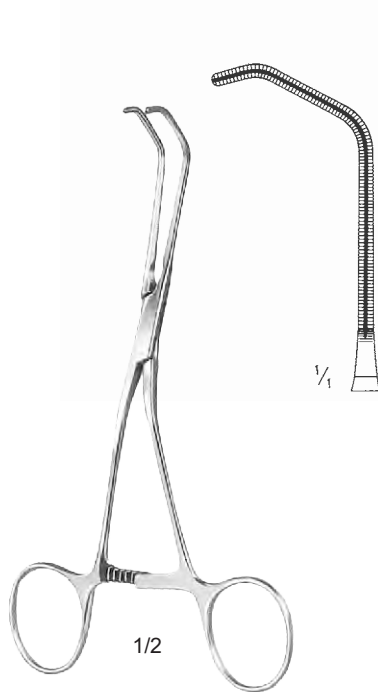

AJ-018307
150mm (6")

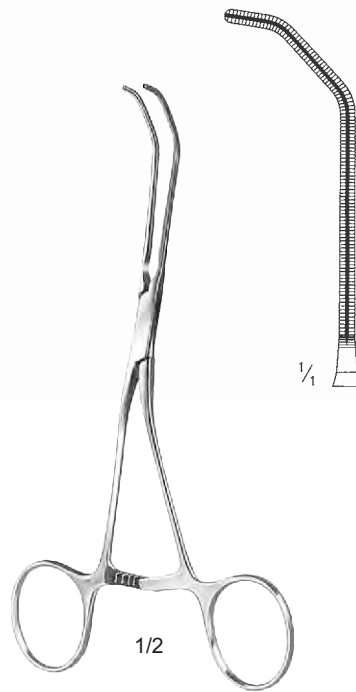

AJ-018308
150mm (6")



NEONATAL CLAMPS VERY DELICATE PATTERNS

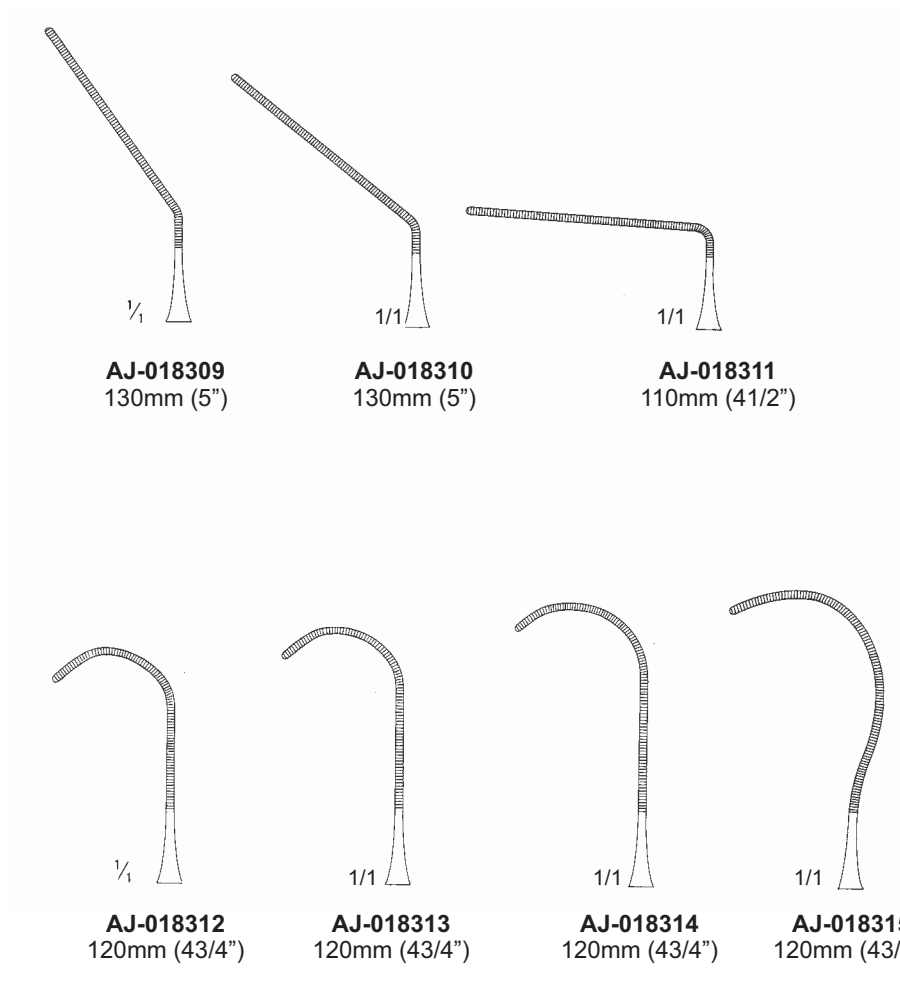

INSTRUMENTS

LIGATURE CARRIERS

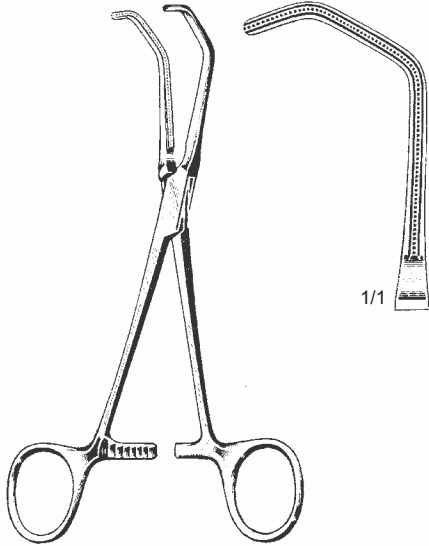

1/1

DE BAKEY-BECK

AJ-018316
165mm (6 1/2")

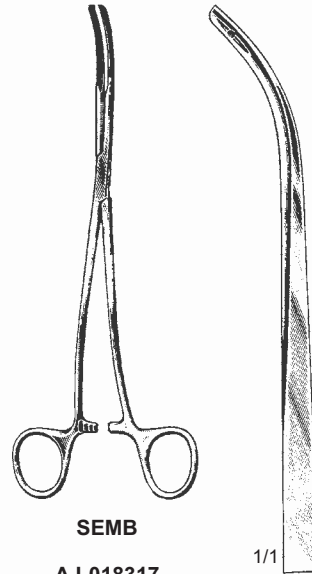

1/1

SEMB

AJ-018317
250mm (10")

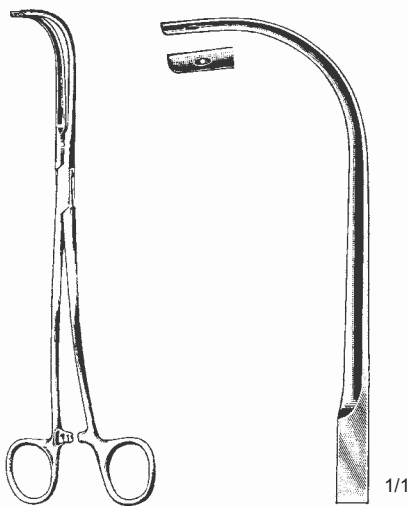

1/1

SEMB

AJ-018318
230mm (9")

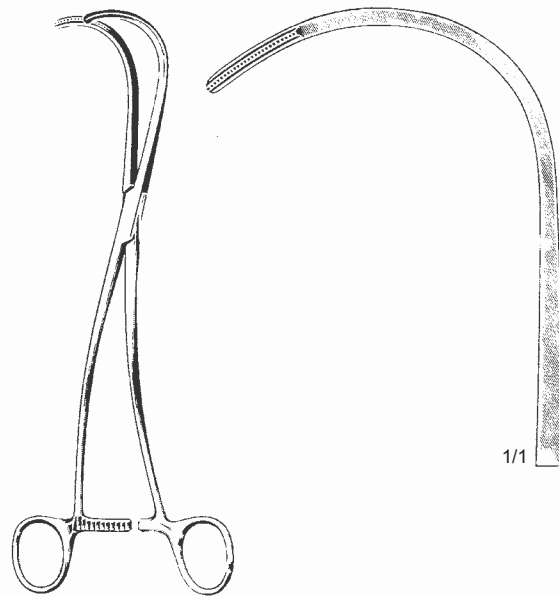

1/1

DE BAKEY

AJ-018319
250mm (10")



CAVAL OCCLUSION CLAMPS



AJ-018320
65mm (2 1/2")

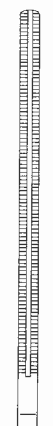
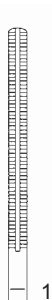

AJ-018321
85mm (3 1/2")



AJ-018322
60mm (2 1/4")

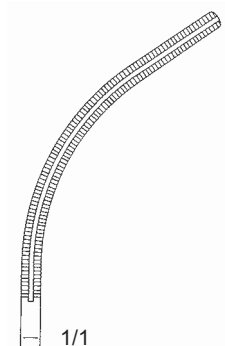
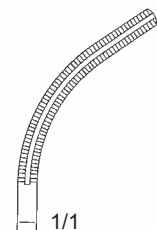

AJ-018323
75mm (3")

MINI COOLEY-GLOVER

MINI COOLEY-GLOVER

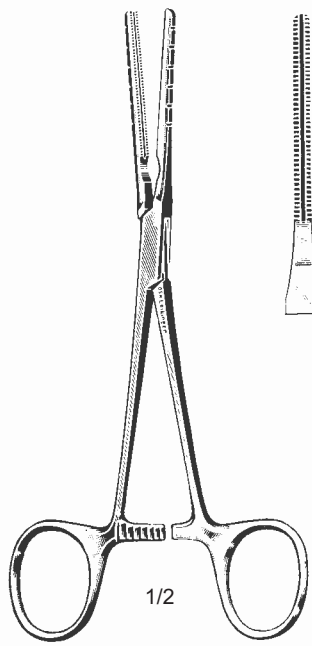

COOLEY
Patent Ducts Clamps

AJ-018324
160mm (6 1/4")

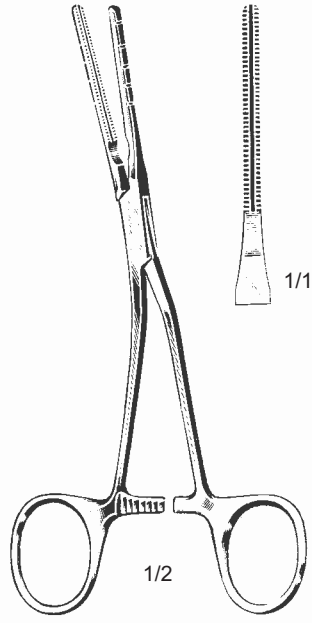
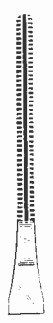

COOLEY
Patent Ducts Clamps

AJ-018325
160mm (6 1/4")

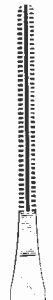

INSTRUMENTS

BULLDOG CLAMPS



1/1

COOLEY



1/1

AJ-018326
70mm (23/8")



1/1

AJ-018327
80mm (31/4")



1/1

AJ-018328
95mm (33/4")



1/1

AJ-018329
115mm (41/2")



1/1

COOLEY



1/1

AJ-018330
65mm (21/2")



1/1

AJ-018331
75mm (3")



1/1

AJ-018332
85mm (31/4")



1/1

AJ-018333
105mm (41/4")



BULLDOG CLAMPS



COOLEY

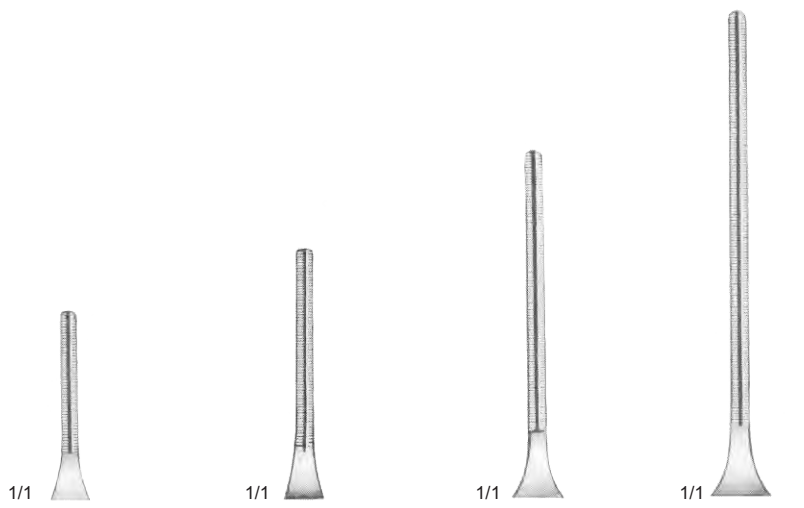

AJ-018334 80mm (3 1/4") **AJ-018335** 90mm (3 1/2") **AJ-018336** 105mm (4 1/4") **AJ-018337** 125mm (5")

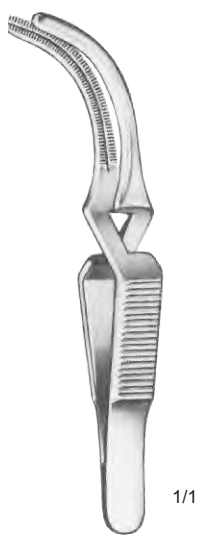

COOLEY

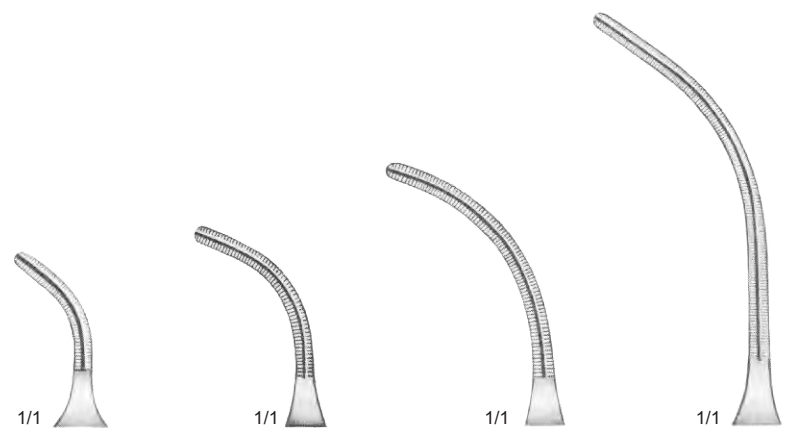

AJ-018338 80mm (3 1/4") **AJ-018339** 85mm (3 1/2") **AJ-018340** 95mm (3 3/4") **AJ-018341** 120mm (4 1/4")

INSTRUMENTS

BULLDOG CLAMPS



AJ-018342
90mm(3 1/2")
AJ-018343
110mm (4 1/4")



AJ-018344
90mm(3 1/2")
AJ-018345
110mm (4 1/4")



AJ-018346
bent to left
110mm (4 1/4")



AJ-018347
bent to right
110mm (4 1/4")



AJ-018348
8mm



AJ-018349
12mm

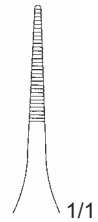

AJ-018350
16mm



AJ-018351
8mm



AJ-018352
12mm

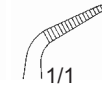

AJ-018353
8mm

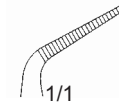

AJ-018354
12mm

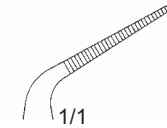

AJ-018355
16mm

MICRO BULLDOG CLAMPS



BULLDOG CLAMPS



APPLYING FORCEPS

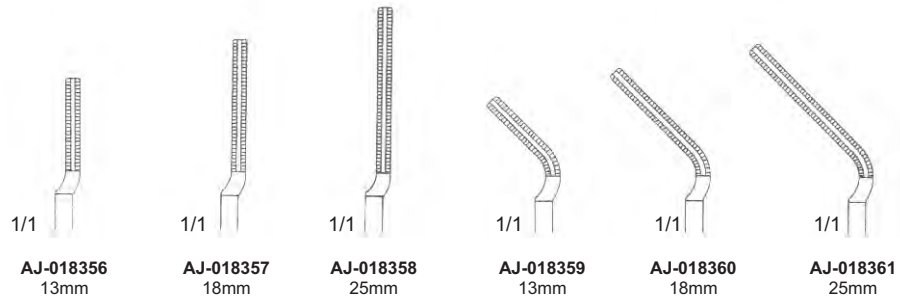

BULLDOG CLAMP



JOHNS HOPKINS

- AJ-018362 38mm
- AJ-018363 51mm
- AJ-018364 57mm
- AJ-018365 63mm
- AJ-018366 70mm
- AJ-018367 75mm
- AJ-018368 90mm

BULLDOG CLAMPS



PERIPHERAL

AJ-018369
180mm (7")



DE BAKEY

AJ-018370 160mm (6 1/4")
AJ-018371 200mm (8")
AJ-018372 240mm (9 1/4")
AJ-018373 300mm (12")

24mm

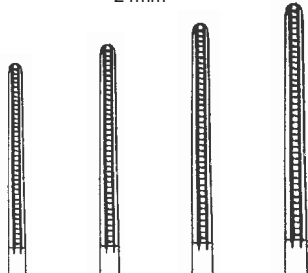

30mm

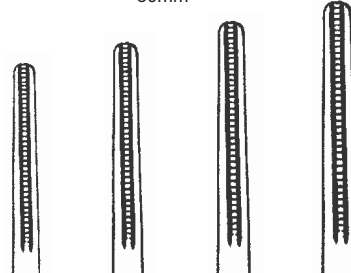

DE BAKEY

AJ-018374 160mm (6 1/4")
AJ-018375 200mm (8")
AJ-018376 240mm (9 1/4")
AJ-018377 300mm (12")



STERILIZATION TRAYS



EDINBURGH TRAYS

- AL-019000** Edinburgh Tray Open Corner with Lips 12"x10"
- AL-019001** Edinburgh Tray Open Corner with Lips 12"x12"
- AL-019002** Edinburgh Tray Open Corner with Lips 12"x18"
- AL-019003** Edinburgh Tray Open Corner with Lips 12"x24"
- AL-019004** Edinburgh Tray Open Corner with Lips 18"x18"
- AL-019005** Edinburgh Tray Open Corner with Lips 18"x24"
- AL-019006** Edinburgh Tray Open Corner with Lips 24"x24"

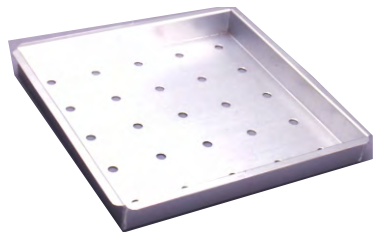

PERFORATED

- AL-019007** Edinburgh Tray Closed Corner with Lips 12"x10"
- AL-019008** Edinburgh Tray Closed Corner with Lips 12"x12"
- AL-019009** Edinburgh Tray Closed Corner with Lips 12"x18"
- AL-019010** Edinburgh Tray Closed Corner with Lips 12"x24"
- AL-019011** Edinburgh Tray Closed Corner with Lips 18"x18"
- AL-019012** Edinburgh Tray Closed Corner with Lips 18"x24"
- AL-019013** Edinburgh Tray Closed Corner with Lips 24"x24"

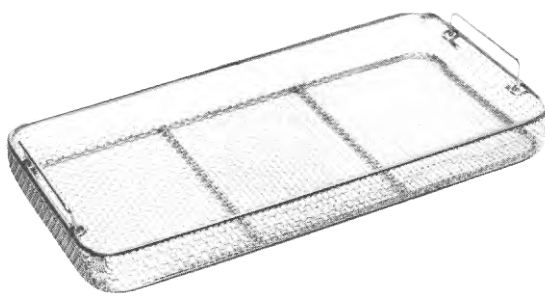

STERILIZATION TRAY

Wire Mesh

- AL-019014**
240 x 250 x 5 mm
- AL-019015**
480 x 250 x 5mm
- AL-019016**
550 x 250 x 5mm

Wire mesh Tray and basket can be made in any size on request



STERILIZATION TRAY

Perforated Steel Mesh

- AL-019017**
26 x 26 x 5mm
- AL-019018**
480 x 250 x 5mm

HOLLOW WEARS



JUG GRADUATED
Stainless Steel

- AL-019019 250 ml
- AL-019020 500 ml
- AL-019021 1000 ml



AL-019022
100 x 20 mm

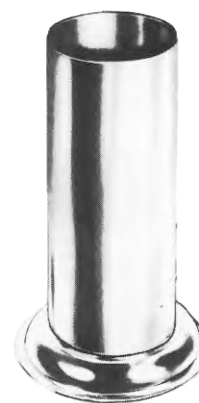

- AL-019023 30 x 90mm
- AL-019024 50 x 100mm
- AL-019025 50 x 130mm
- AL-019026 50 x 175mm
- AL-019027 75 x 100mm
- AL-019028 75 x 130mm
- AL-019029 75 x 175mm
- AL-019030 100 x 175mm
- AL-019031 100 x 200mm



LOTION BOWL

- AL-019032 165 x 60 075
- AL-019033 175 x 70 100
- AL-019034 220 x 80 200
- AL-019035 225 x 90 250
- AL-019036 240 x 110 300
- AL-019037 255 x 115 400
- AL-019038 275 x 115 450
- AL-019039 290 x 125 600
- AL-019040 310 x 120 600
- AL-019041 345 x 125 850
- AL-019042 380 x 130 1100
- AL-019043 415 x 140 1400



KIDNEY DISH

- AL-019044 125mm (5")
- AL-019045 150mm (6")
- AL-019046 180mm (7")
- AL-019047 250mm (10")
- AL-019048 300mm (12")



BUCKET

- AL-019049 Bucket Stainless Steel 10 Liter
- AL-019050 Bucket Stainless Steel 12 Liter
- AL-019051 Bucket Stainless Steel 15 Liter



BIPOLAR FORCEPS



**McPHERSON
AD-020100**
70mm
(23/4")
Straight



**McPHERSON
AD-020101**
70mm
(23/4")
Angled



**JEWELER
FORCEPS
AD-020102**
110 mm
(41/4")
Straight



**JEWELER
FORCEPS
AD-020103**
110 mm
(41/4")
Angled



**JEWELER
FORCEPS
AD-020104**
110 mm
(41/4")
Curved



**BIPOLAR FORCEPS
Straight**
AD-020105 150mm (6")
AD-020106 180mm (7")
AD-020107 200mm (8")
AD-020108 220mm (8 1/2")
AD-020109 240mm (9 1/2")

BIPOLAR FORCEPS



**BIPOLAR FORCEPS
BAYONETT**
AD-020110 180mm (7")
AD-020111 200mm (8")
AD-020112 220mm (8 1/2")
AD-020113 240mm (9 1/2")

BIPOLAR FORCEPS
Angled downward
AD-020114 150mm (6")
AD-020115 180mm (7")
AD-020116 200mm (8")
AD-020117 220mm (8 1/2")
AD-020118 240mm (9 1/2")

BIPOLAR FORCEPS
BAYONETT
Angled Upward
AD-020119 180mm (7")
AD-020120 200mm (8")
AD-020121 220mm (8 1/2")
AD-020122 240mm (9 1/2")

BIPOLAR FORCEPS
BAYONETT
Angled Downward
AD-020123 180mm (7")
AD-020124 200mm (8")
AD-020125 220mm (8 1/2")
AD-020126 240mm (9 1/2")



MONOPOLAR CABLES

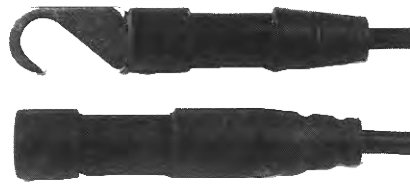

MONOPOLAR CABLES

AD-020127 3 meter cable, Hook connector, cable with active instrument connector

AD-020128 5 meter cable, Hook connector, cable with active instrument connector

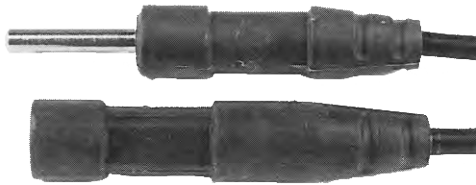

AD-020129 3 meter cable, 4mm plug, cable with active instrument connector

AD-020130 5 meter cable, 4mm plug, cable with active instrument connector

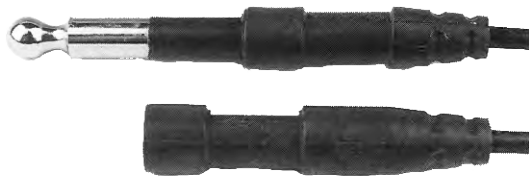

AD-020131 3 meter cable, 8mm jack plug (Bovie) cable with active instrument connector

AD-020132 5 meter cable, 8mm jack plug (Bovie) cable with active instrument connector



BI-POLAR CABLES



AD-020133
Bi-polar cable 4mm coaxible machine end



AD-020134
Bi-polar cable wolf machine end

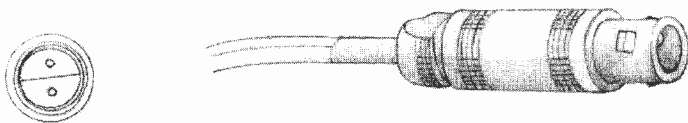

AD-020135
Bi-polar cable Eschman (Lemo) machine end

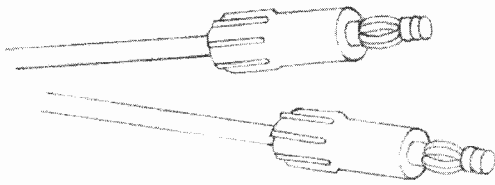

AD-020136
Bi-polar cable twin 4mm machine end

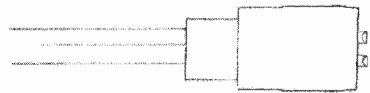

AD-020137
Bi-polar cable Aesculap machine end

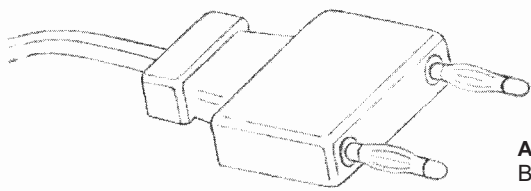

AD-020138
Bi-polar cable Valley lab machine end



BI-POLAR CABLES

AD-020139
Bi-polar cable European instrument end



AD-020140
Bi-polar cable Wolf instrument end

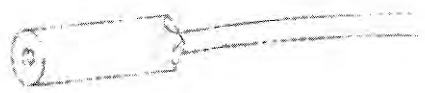

AD-020141
Bi-polar cable USA instrument end



AD-020142
Bi-polar cable Thackray blade instrument end



AD-020143
Bi-polar cable Thackray pin instrument end



MONOPOLAR FORCEPS



DISSECTING FORCEPS

AD-020144
150mm (6")
180mm (7")



DISSECTING FORCEPS

AD-020145
200mm (8")
250mm (10")



MCINDOE FORCEPS

AD-020146
150mm (6")



ADSON

AD-020147
100mm (7 1/2")



WILSON HEY FORCEPS

AD-020148
150mm (6")



WILSON HEY FORCEPS

AD-020149 180mm (7"), **AD-020150** 230mm (9")



RICHES FORCEPS

AD-020151
125mm (5")
AD-020152
150mm (6")
AD-020153
180mm (7")
AD-020154
200mm (8")
AD-020155
230mm (9")



MONOPOLAR HANDLES, BLADES, NEEDLE, TURNER WARWICK SCISSORS



HANDLES
For ball and plate electrode carriers
AD-020156
17mm (61/4")



HANDLES
For needles and loops
AD-020157
200mm (8")



HANDLES
For needles and loops
AD-020158
15mm (6")



BLADES
AD-020159
Large Diathermy blade electrode (Insulated)



BLADES
AD-020160
Large Diathermy blade electrode (Non-Insulated)



BLADES
AD-020161
Small Diathermy blade electrode



NEEDLE
AD-020162
Short Sharp



NEEDLE
AD-020163
Long Insulated



NEEDLE
AD-020164
Long Sharp Angled



NEEDLE
AD-0201654
Long Sharp Straight



TURNER WARWICK SCISSOR
AD-020166 125mm (5")
AD-020167 145mm (51/4")
AD-020168 150mm (6")
AD-020169 180mm (7")
AD-020170 230mm (9")



SCALPLE HANDLE
AD-020171
No3, No4

COLPOSOPY LOOPS



AD-020172
8mm large loop electrode



AD-020173
12mm large loop electrode

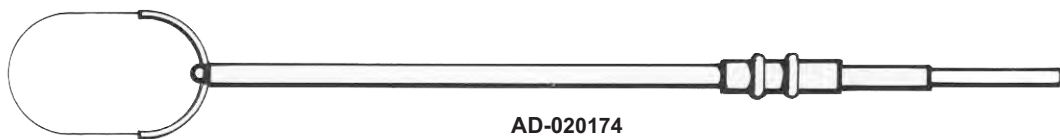

AD-020174
15mm large loop electrode

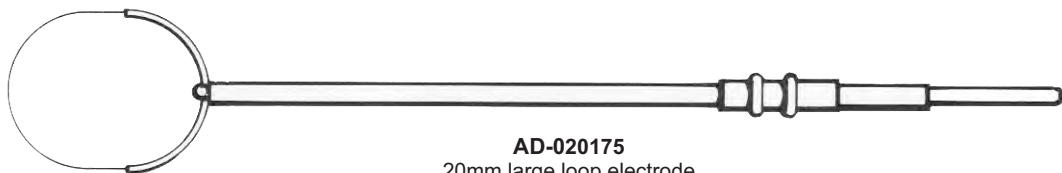

AD-020175
20mm large loop electrode

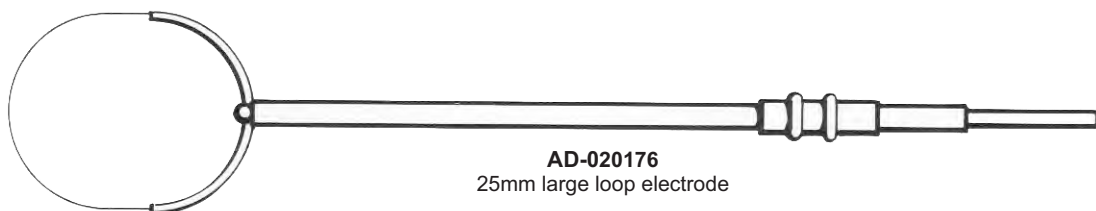

AD-020176
25mm large loop electrode



AD-020177
3mm extended ball electrode



AD-020178
5mm extended ball electrode



QUIVER, FINGER SWITCH PENCILS

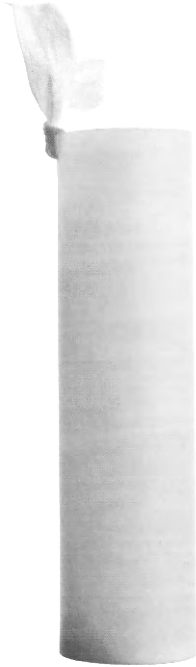

DIATHERMY QUIVER
AD-020179
 40mm diameter with ring
AD-020180
 60mm diameter with ring



AD-020181
BALL ELECTRODE



AD-020182
NEEDLE ELECTRODE



AD-020187
EXTENDED
BLADE ELECTRODE



AD-020188
SWITCHING PENCIL
 3m cord
AD-020189
 5m cord

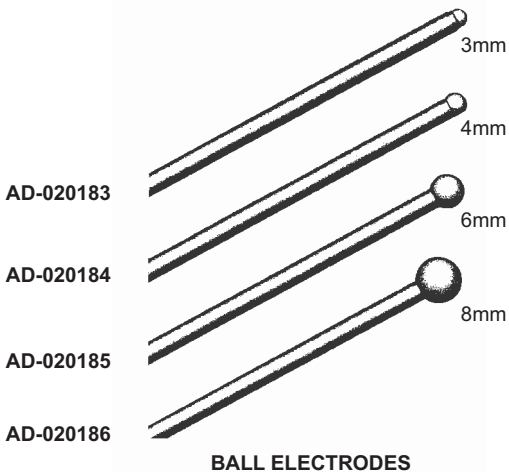

AD-020183
AD-020184
AD-020185
AD-020186

BALL ELECTRODES



INDEX

A

AMERICAN PATTERN (SCISSORS)	14
AUFRICHT (SCISSORS)	15
ADSON (DELICATE DISSECTING FORCEPS)	42
ADSON (TOOTHED DISSECTING FORCEPS)	45
ADSON-BROWN (TOOTHED DISSECTING FORCEPS)	45
ARTHURE (SPLINTER FORCEPS)	48
ADSON ("TC" DISSECTING FORCEPS)	49
ALLIS ("TC" DISSECTING FORCEPS)	51
ADSON-BROWN ("TC" DISSECTING FORCEPS)	55
ALLIS (TISSUE FORCEPS)	88
AMERICAN PATTERN ALLIS (TISSUE FORCEPS)	88
ARRUGA (MICRO NEEDLE HOLDERS)	92
ANEL LACHRYMAL (PROBES)	138
ABDOMINAL RETRACTOR (HAND HELD RETRACTORS)	173
ALLISON (HAND HELD RETRACTORS)	183
ALLISON (HAND HELD RETRACTORS)	184
ALMS (SELF RETAINING RETRACTORS)	196
ADSON (SELF RETAINING RETRACTORS)	200
AUVARD (VAGINAL RETRACTOR)	227
ALEXANDER (CERVICAL BIOPSY FORCEPS)	238
AMINIOTOME (UTERINE CANNULAE)	249
ADSON FRAZIER (SUCTION TUBES)	281
APMUTATION SAW (AMPUTATION INSTRUMENTS)	286
ARMY REEGULATION (AMPUTATION INSTRUMENTS)	286
ADSON (RASPATORIES)	294
ALLISON (RIB SPREADERS)	341
APPLYING FORCEPS (ATRAUMA BULLDOG CLAMPS)	353
ANEURYSM (ATRAUMA CARDIOVASCULAR FORCEPS)	359
APPLYING FORCEPS (BULLDOG CLAMPS)	395
ADSON (MONOPOLAR CABLES)	404

B

BARRON (SURGICAL HANDLES)	04
BRAITHWAITE (SKIN GRAFTING KNIVES)	08
BRAUN STADTLER EPISIOTOMY (SCISSORS)	14
BABY METZANBAUM ("TC" SCISSORS)	23
BABY METZENBAUM ("TC" SCISSORS)	29
BONNEY (SERRATED DISSECTING FORCEPS)	39
BICKFORD (SERRATED DISSECTING FORCEPS)	39
BONNEY (TOOTHED DISSECTING FORCEPS)	46
BICKFORD (TOOTHED DISSECTING FORCEPS)	46
BABCOCK ("TC" DISSECTING FORCEPS)	51
BABY - ADSON (DISSECTING & LIGATURE FORCEPS)	52
BABCOCK (TISSUE FORCEPS)	57
BALL AND SOCKET (TOWEL CLAMPS)	64
BACKHAUS (TOWEL CLAMPS)	64
BOZEMANN UTERINE (DRESSING FORCEPS)	67
BOZEMANN UTERINE (DRESSING FORCEPS)	68
BABY - CRILE (HAEMOSTATS FORCEPS)	69
BABY - CRILE (HAEMOSTATS FORCEPS)	70
BIRKETT (HAEMOSTATS FORCEPS)	81
BABY - ADSON (DISSECTING & LIGATURE FORCEPS)	85
BARRAQUER (MICRO NEEDLE HOLDERS)	92
BABY-CRILE-WOOD ("TC" NEEDLE HOLDERS)	102
BAUMGARTNER ("TC" NEEDLE HOLDERS)	102
("TC" NEEDLE HOLDERS)	111

C

BAUMGARTNER ("TC" NEEDLE HOLDERS)	111
BOWMAN (OPHTHALMOLOGY)	120
BANGERTER (OPHTHALMOLOGY)	124
BRODIE (PROBES)	136
BONNEY (SUTURE INTERUMENTS)	144
BALLANCE (HAND HELD RETRACTORS)	166
BARSKY SKIN HOOK (RETRACTORS)	178
BOWDLER-HENRY RAKE (HAND HELD RETRACTORS)	179
BALFOUR ABDOMINAL (RETRACTORS)	187
BERKELEY ABDOMINAL (SELF RETAINING RETRACTORS)	190
BECKMANN-ADSON (SELF RETAINING RETRACTORS)	200
BAKES (GALL DUCT DILATORS / SCOOPS)	209
BLACKE (CHOLECYSTECTOMY & GALL STONE FORCEPS)	211
BROWN (DRESSING FORCEPS)	229
BROWN (TENACULUM FORCEPS)	230
BONNEY POLYPI (OVUM FORCEPS)	234
BURKE (CERVICAL BIOPSY FORCEPS)	240
BIOPSY CUTTING (CERVICAL BIOPSY FORCEPS)	242
BARNES (UTERINE CANNULAE)	249
BUMM (UTERINE CANNULAE)	250
BARTON (OBSTETRIC INSTRUMENTS)	252
BOERMA (OBSTETRIC INSTRUMENTS)	253
BRAUN (OBSTETRIC MIDWIFERY)	254
BONNEY (HYSTERECTOMY CLUMPS)	260
BARRON HAEMORRHOID (PROCTOLOGY HAEMORRHOIDAL)	269
BLADDER SPATULA (UROLOGY)	273
BARRON (SUCTION TUBES)	282
BELUCCI (SUCTION TUBES)	282
BRISTOW (RASPATORIES)	295
BURNS (BONE HOLDING FORCEPS)	310
BEYER (BONE RONGEURS)	314
BEYER (BONE RONGEURS)	317
BECK RONGEUR (DISC RONGEURS)	321
BRUNNER (BONE & RIB SHEARS)	330
BURFORD (RIB SPREADERS)	333
BAILEY-BABY (RIB SPREADERS)	341
BAINBRIDGE (ATRAUMA CARDIOVASCULAR FORCEPS)	358
BECK (ATRAUMA CARDIOVASCULAR FORCEPS)	374
BULLDOG CLAMPS (BULLDOG CLAMPS)	395
BUCKET (HOLLOW WEARS)	398
BIPOLAR FORCEPS (BIPOLAR FORCEPS)	399
BIPOLAR FORCEPS (BIPOLAR FORCEPS)	400
BLADES (MONOPOLAR HANDLES, BLADES, NEEDLE, TURNER, SCISSORS)	405
BALL ELECTRODES (QUIVER, FINGER SWITCH PENCILS)	407
COBBETT (SKIN GRAFTING KNIVES)	07
CRAFOORD (SCISSORS)	13
COUNTER SCISSORS (SCISSORS)	20
CANADIAN (SERRATED DISSECTING FORCEPS)	36
CAIRNS (DOTT) (DELICATE DISSECTING FORCEPS)	42
CANADIAN (TOOTHED DISSECTING FORCEPS)	46
CUSHING ("TC" DISSECTING FORCEPS)	49
CUSHING ("TC" DISSECTING FORCEPS)	53
COLLIN TONGUE FORCEPS (TONGUE DEPRESSORS)	61
CUSHING (HAEMOSTATS FORCEPS)	71
CAIRNS (HAEMOSTATS FORCEPS)	72
CRAFOORD (HAEMOSTATS FORCEPS)	72



INDEX

CRILE (HAEMOSTATS FORCEPS)	72	DISSECTING FORCEPS (SERRATED DISSECTING FORCEPS)	36
CRILE (HAEMOSTATS FORCEPS)	73	DISSECTING FORCEPS (SERRATED DISSECTING FORCEPS)	37
CHAPUT (POIRIER) (TISSUE FORCEPS)	89	DISSECTING FORCEPS (SERRATED DISSECTING FORCEPS)	38
CHAPUT (POIRIER) (TISSUE FORCEPS)	90	DISSECTING FORCEPS (TOOTHED DISSECTING FORCEPS)	43
CASTROVIEJO(MICRO NEEDLE HOLDERS)	92	DENIS BROWNE (SPLINTER FORCEPS)	48
CONVERSE (NEEDLE HOLDERS)	93	DEBAKEY ("TC" DISSECTING FORCEPS)	53
CRILE WOOD (NEEDLE HOLDERS)	94	DUVAL (TISSUE FORCEPS)	58
CRILE MURRAY (NEEDLE HOLDERS)	94	DOYEN (CHILD) (MOUTH GAGS)	59
CASTROVIEJO("TC" NEEDLE HOLDERS)	100	DOYEN (ADULT) (MOUTH GAGS)	59
CRILE - WOOD ("TC" NEEDLE HOLDERS)	101	DOYEN (TOWEL CLAMPS)	63
CONVERSE ("TC" NEEDLE HOLDERS)	102	DUNHILL (HAEMOSTATS FORCEPS)	78
CRILE - WOOD ("TC" NEEDLE HOLDERS)	102	DERF (NEEDLE HOLDERS)	93
COMBINED SCISSOR ("TC" NEEDLE HOLDERS)	104	DERF ("TC" NEEDLE HOLDERS)	101
CAWTHORNE (PROBES)	138	DEBAKEY ("TC" NEEDLE HOLDERS)	104
CHILDES(SUTURE INTERUMENTS)	144	DEBAKEY ("TC" NEEDLE HOLDERS)	105
CHARNLEY (SUTURE INTERUMENTS)	145	DESCHAMPS (ANEURYSM NEEDLES)	146
CUSHINGS VEIN(HAND HELD RETRACTORS)	160	DESCHAMPS (ANEURYSM NEEDLES)	147
CZERNY(HAND HELD RETRACTORS)	166	DESCHAMPS (ANEURYSM NEEDLES)	148
CANNY RYAL (HAND HELD RETRACTORS)	168	DEAVER (HAND HELD RETRACTORS)	149
CAIRNS "RAKE"(HAND HELD RETRACTORS)	180	DEAVER (HAND HELD RETRACTORS)	150
CAIRNS STRIP(HAND HELD RETRACTORS)	180	DEAVER (HAND HELD RETRACTORS)	151
CRILE (HAND HELD RETRACTORS)	181	DEAVER GRIP (HAND HELD RETRACTORS)	152
CUSHING (HAND HELD RETRACTORS)	181	DEAVER GRIP (HAND HELD RETRACTORS)	153
CAIRNS (HAND HELD RETRACTORS)	181	DURHAM (HAND HELD RETRACTORS)	158
CAIRNS SCALP (SELF RETAINING RETRACTORS)	196	DOYEN (HAND HELD RETRACTORS)	171
CONE (SELF RETAINING RETRACTORS)	197	DOYEN (HAND HELD RETRACTORS)	172
CONE LAMINECTOMY (SELF RETAINING RETRACTORS)	198	DESMARRES (HAND HELD RETRACTORS)	177
CONE LAMINECTOMY (SELF RETAINING RETRACTORS)	198	DAVISON (HAND HELD RETRACTORS)	184
CHARLEY INITIAL INCISION(SELF RETAINING RETRACTORS)	202	DESJARDINS (GALL DUCT PROBES)	208
CHARLEY PIN(SELF RETAINING RETRACTORS)	202	DESJARDINS (GALL DUCT DILATORS / SCOOPS)	209
CHOLANGIOGRAM (CHOLECYSTECTOMY & GALL STONE FORCEPS)	212	DESJARDINS (GALL STONE SCOOPS / FORCEPS)	210
CUSSO (VAGINAL SPECULUM)	222	DUCT DISSECTING (CHOLECYSTECTOMY & GALL STONE FORCEPS)	211
CZERNY (PROCTOLOGY)	265	DOYEN (INTESTINAL CLAMPS)	213
CLUTTON URETHRAL SOUND(UROLOGY)	279	DOYEN (INTESTINAL CLAMPS)	214
CHIP SYRINGE (SUCTION TUBES)	284	DOYEN ROBSON (INTESTINAL CLAMPS)	215
CAIRNS SKULL FLAP (BONE LEVERS & ELEVATORS)	287	DOYEN (VAGINAL SPECULUM)	225
COBRA HIP LEVER (BONE LEVERS)	292	DOYEN (OVUM FORCEPS)	234
COLLIER AND MORRIS (BONE SCOOPS)	300	DARTIGUES (UTERINE ELEVATOR FORCEPS)	235
CAPENER CHISELS (OSTEOTOMES, CHISELS & GOUGES)	301	DOYEN (MYOMA INSTRUMENTS)	236
CAPENER OSTEOTOME (OSTEOTOMES, CHISELS & GOUGES)	302	DOUBLE ENDED (UTERINE CURETTES)	245
CAIRNS (BONE RONGEURS)	314	DeLEE (OBSTETRIC INSTRUMENTS)	251
CUSHING (DISC RONGEURS)	321	DEWEY (OBSTETRIC INSTRUMENTS)	253
CAST BENDING FORCEPS (PLASTER CAST)	327	DINGMAN (BONE HOLDING FORCEPS)	312
COOLEY(RIB SPREADERS)	331	DE VILBISS (BONE CUTTING FORCEPS)	326
CASTANEDA (RIB SPREADERS)	334	DE-BAKEY SATINSKY (ATRAUMA BULLDOG CLAMPS)	344
COOLEY(ATRAUMA CARDIOVASCULAR FORCEPS)	351	DE-BAKEY RANKIN (ATRAUMA HEMOSTATIC FORCEPS)	345
COOLEY (ATRAUMA CARDIOVASCULAR FORCEPS)	376	DIETRICH (ATRAUMA CARDIOVASCULAR FORCEPS)	346
COOLEY (VASCULAR DILATORS)	381	DALE (ATRAUMA CARDIOVASCULAR FORCEPS)	347
CASTANEDA (NEONATAL CLAMPS)	389	DE BAKEY (ATRAUMA TISSUE FORCEPS)	352
COOLEY (CAVAL OCCLUSION CLAMPS)	391	DEBAKEY BULLDOG CLAMPS (ATRAUMA BULLDOG CLAMPS)	353
COOLEY (BULLDOG CLAMPS)	392	DE BAKEY (ATRAUMA CARDIOVASCULAR FORCEPS)	356
		DE BAKEY (ATRAUMA CARDIOVASCULAR FORCEPS)	357
		DE BAKEY BAHNSON (ATRAUMA CARDIOVASCULAR FORCEPS)	369
		DE BAKEY BAHNSON (ATRAUMA CARDIOVASCULAR FORCEPS)	371
		DE BAKEY PEAN (ATRAUMA CARDIOVASCULAR FORCEPS)	372
		DE BAKEY (VASCULAR DILATORS)	381
		DE BAKEY-BECK (LIGATURE CARRIERS)	390
			382
D			
DRESSING (SCISSORS)	12		
DOYEN ABDOMINAL (SCISSORS)	20		
DOYEN ABDOMINAL (SCISSORS)	20		
DELICATE SCISSORS ("TC" SCISSORS)	23		
DEBAKEY VASCULAR ("TC" SCISSORS)	28		

DE BAKEY (BULLDOG CLAMPS)	396
DESSECTING FORCEPS (MONOPOLAR CABLES)	404
DIATHERMY QUIVER (QUIVER, FINGER SWITCH PENCILS)	407

E

ERGONOMIC (SURGICAL HANDLES)	01
EMMET (SERRATED DISSECTING FORCEPS)	40
EXTRA FINE (DELICATE DISSECTING FORCEPS)	42
EDNA (LORNA) (TOWEL CLAMPS)	63
EDNA (LORNA) (TOWEL CLAMPS)	63
EAST GRINSTEAD (HAND HELD RETRACTORS)	179
ENDOMETRIAL (CERVICAL BIOPSY)	237
EPPENDORFER (CERVICAL BIOPSY FORCEPS)	241
ELLIOT (OBSTETRIC INSTRUMENTS)	251
ECHLIN (BONE RONGEURS)	318
EDINBURGH TRAYS (STERILIZATION TRAYS)	397
EPERLE TOE NAIL SCISSORS (NAIL SCISSORS)	408

F

FAVALORO (SCISSORS)	19
FINE (TOOTHED DISSECTING FORCEPS)	46
FEILCHENFEL (SPLINTER FORCEPS)	48
FINE CURVED DISSECTING (DISSECTING & LIGATURE FORCEPS)	54
FERGUSON ACLAND (MOUTH GAGS)	59
FEATHERSTONE (MOUTH GAGS)	59
FLAT TONGUE DEPRESSOR (TONGUE DEPRESSORS)	60
FORESTER (SPONGE HOLDING FORCEPS)	66
FRASER - ADSON (HAEMOSTATS FORCEPS)	78
FRASER-KELLY (CRILE) (HAEMOSTATS FORCEPS)	78
FICKLING ORAL (HAEMOSTATS FORCEPS)	84
FINE CURVED (DISSECTING & LIGATURE FORCEPS)	86
FINOCHIETTO ("TC" NEEDLE HOLDERS)	110
FISTULA PROBE (PROBES)	139
FARABEUF (HAND HELD RETRACTORS)	163
FINSON (SELF RETAINING RETRACTORS)	195
FINCH EXCISION (INTESTINAL CLAMPS)	219
FRENCH MODEL PELVIMETER (UTERINE CANNULAE)	249
FOX (DERMATOLOGY INSTRUMENTS)	255
FAURE (PERITONEUM INSTRUMENTS)	258
FEMALE CATHETERS (UROLOGY)	279
FRAZIER (SUCTION TUBES)	281
FINGER SAW (AMPUTATION INSTRUMENTS)	286
FREERB ELEVATOR (RASPATORIES)	294
FARABEUF (RASPATORIES)	296
FICKLING DENTAL (MALLETS)	307
FERGUSON (BONE HOLDING FORCEPS)	308
FINOCHIETTO (RIB SPREADERS)	332
FINOCHIETTO (RIB SPREADERS)	335
FINOCHIETTO -BABY (RIB SPREADERS)	336
FINOCHIETTO (RIB SPREADERS)	337
FINOCHIETTO -MARTIN (RIB SPREADERS)	338

G

GILLIES (TOOTHED DISSECTING FORCEPS)	44
GREY TURNER (HAEMOSTATS FORCEPS)	71
GILLIES (NEEDLE HOLDERS)	95
GILLIES ("TC" NEEDLE HOLDERS)	104
GRAEFE (OPHTHALMOLOGY)	119
GRAEFE (OPHTHALMOLOGY)	122
GWYNNE EVANS TONSIL (DISSECTORS)	142
GILLIES SKIN HOOK (RETRACTORS)	178
GOSSET (RETRACTOR)	188
GOLIGHER (SELF RETAINING RETRACTORS)	190
GELPI VULVA (SELF RETAINING RETRACTORS)	195
GEARY GRANT (CHOLECYSTECTOMY & GALL STONE)	205
GALL DUCT SCISSORS (CHOLECYSTECTOMY & GALL STONE)	207
GRAVE (VAGINAL SPECULUM)	223
GALABIN (UTERINE DILATORS / PROBES)	228
GRAEM ANDERSON (PROCTOLOGY)	264
GABRIEL RECTAL (PROCTOLOGY)	264
GABRIEL METAL AND GLASS (HAEMORRHOIDAL SYRINGES)	271
GUYON (UROLOGY)	272
GILLIES (SUCTION TUBES)	280
GOUGES (OSTEOTOMES, CHISELS & GOUGES)	303
GIGI SAW WITH HANDLE (BONE RONGEURS)	317
GLUCK (BONE & RIB SHEARS)	329
GIERTZ STILLE (BONE & RIB SHEARS)	330
GLOVER (ATRAUMA BULLDOG CLAMPS)	344
GREGORY-SOFT (ATRAUMA BULLDOG CLAMPS)	344
GREGORY (ATRAUMA CARDIOVASCULAR FORCEPS)	248
GLOVER (ATRAUMA CARDIOVASCULAR FORCEPS)	354
GLOVER (ATRAUMA CARDIOVASCULAR FORCEPS)	374

H

HUMBY (SKIN GRAFTING KNIVES)	08
HEGEMANN'S DELICATE (SCISSORS)	15
HEYMANN TURBINECTOMY (DELICATE SCISSORS)	17
HEDGEMAN (SCISSORS)	19
HYSTERECTOMY ("TC" SCISSORS)	27
HUNTER (SPLINTER FORCEPS)	48
HEYWOOD-SMITH TONGUE FORCEPS (TONGUE DEPRESSORS)	61
HALSTEAD MOSQUITO (HAEMOSTATS FORCEPS)	69
HALSTEAD MOSQUITO (HAEMOSTATS FORCEPS)	70
HEISS (HAEMOSTATS FORCEPS)	81
HEANEY (NEEDLE HOLDERS)	95
HALSEY (NEEDLE HOLDERS)	98
HALSEY ("TC" NEEDLE HOLDERS)	101
HALSEY ("TC" NEEDLE HOLDERS)	102
HAGAR-MAYO ("TC" NEEDLE HOLDERS)	103
HAGER-OSLEN ("TC" NEEDLE HOLDERS)	104
THOMSON-WALKER ("TC" NEEDLE HOLDERS)	108
HAENEY ("TC" NEEDLE HOLDERS)	109
HOESEL ("TC" NEEDLE HOLDERS)	113
HAJEK (RETRACTORS)	178
HARRINGTON (HAND HELD RETRACTORS)	182
HARRINGTON - PEMBERTON (HAND HELD RETRACTORS)	183
HENDERSON (SELF RETAINING RETRACTORS)	197
HARVEY-JACKSON LAMINECTOMY (SELF RETAINING RETRACTORS)	199
HAYES (INTESTINAL CLAMPS)	221

INDEX

LANGENBECK (HAND HELD RETRACTORS)	161	MAYO (SUPER CUT SCISSORS)	35
LEMPERT (HAND HELD RETRACTORS)	166	McIndoe (SUPER CUT SCISSORS)	35
LAGENBECK-GREEN (HAND HELD RETRACTORS)	168	MAINGOT INTESTINAL (SERRATED DISSECTING FORCEPS)	40
LLOYD DAVIS (HAND HELD RETRACTORS)	170	MACINDOE (DELICATE DISECTING FORCEPS)	41
LANGEBECK (HAND HELD RETRACTORS)	175	MICINDOE (TOOTHED DISSECTING FORCEPS)	44
LOGAN (SELF RETAINING RETRACTORS)	196	MUSTARDE (TOOTHED DISSECTING FORCEPS)	47
LAHEY (CHOLECYSTECTOMY & GALL STONE)	205	MICRO SOFT TOUCH RING TIP (SPLINTER FORCEPS)	48
LOWER (CHOLECYSTECTOMY & GALL STONE)	205	MICRO ADSON (DISSECTING & LIGATURE FORCEPS)	52
LANE (INTESTINAL CLAMPS)	216	MERIAM ("TC" DISSECTING FORCEPS)	53
LANG STEVENSON (INTESTINAL CLAMPS)	217	MAGILL CATHETER INTRODUCING (PREPARATION INSTRUMENTS)	62
LANE TWIN ANASTOMOSIS (INTESTINAL CLAMPS)	218	MAYO (TOWEL CLAMPS)	64
LLOYD DAVIS RECTAL OCCLUSION (INTESTINAL CLAMPS)	220	MOYNIHAN (TOWEL CLAMPS)	64
LEECH WILKINSON (CERVICAL BIOPSY FORCEPS)	238	MAYO SAFETY (SAFETY PIN FORCEPS HOLDERS)	65
LEECH-WILKINSON (OBSTETRIC INSTRUMENTS)	246	MAYO (HAEMOSTATS FORCEPS)	75
LUIKART (OBSTETRIC INSTRUMENTS)	252	MOYNIHAN (HAEMOSTATS FORCEPS)	83
LUIKART-BILL (OBSTETRIC INSTRUMENTS)	253	MIXTER (HAEMOSTATS FORCEPS)	83
LLOYD DAVIES (SIGMOIDOSCOPY)	266	MICRO ADSON (DISSECTING & LIGATURE FORCEPS)	85
LLOYD DAVIES (SIGMOIDOSCOPY)	267	MIXTER (DISSECTING & LIGATURE FORCEPS)	87
LLOYD DAVIES (SIGMOIDOSCOPY)	268	MAYO (DUNHILL) (NEEDLE HOLDERS)	93
LISTON (AMPUTATION INSTRUMENTS)	285	MAYO (BAUMGARTNER) (NEEDLE HOLDERS)	97
LANGENBECK (AMPUTATION INSTRUMENTS)	285	MATHIEU (NEEDLE HOLDERS)	98
LANE BONE LEVER (BONE LEVERS & ELEVATORS)	287	MAYO (NEEDLE HOLDERS)	99
LAMBOTE (RASPATORIES)	295	MCPHAILS (NEEDLE HOLDERS)	99
LANGENBECK (RASPATORIES)	295	MASING ("TC" NEEDLE HOLDERS)	101
LEMPERT (BONE SCOOPS)	300	MAYO ("TC" NEEDLE HOLDERS)	107
LAMBOTTE (OSTEOTOMES, CHISELS & GOUGES)	302	MAYO-HEGAR ("TC" NEEDLE HOLDERS)	108
LUCAE (MALLETS)	305	MASSON ("TC" NEEDLE HOLDERS)	110
LANE (BONE HOLDING FORCEPS)	310	MATHIEU ("TC" NEEDLE HOLDERS)	112
LOWMAN (BONE HOLDING FORCEPS)	310	MEYHOEFER (OPHTHALMOLOGY)	123
LEWIN (BONE HOLDING FORCEPS)	311	MYRTLE LEAF PROBE (PROBES)	137
LEWIN (BONE HOLDING FORCEPS)	312	MACDONALD (DISSECTORS)	140
LANE (BONE HOLDING FORCEPS)	313	MICHEL (SUTURE INTERUMENTS)	144
LUER (BONE RONGEURS)	314	MILLIN NEEDLE (SUTURE INTERUMENTS)	145
LEKSELL (BONE RONGEURS)	316	MORRIS (HAND HELD RETRACTORS)	155
LEMPERT (BONE RONGEURS)	320	MIDDELDORPF (HAND HELD RETRACTORS)	158
LISTON (BONE CUTTING FORCEPS)	323	MOYNIHAN (HAND HELD RETRACTORS)	159
LEBSCHER (BONE & RIB SHEARS)	330	MCINDOE SKIN HOOK (RETRACTORS)	178
LOVELACE (TISSUE AND ORGAN)	343	MCINDOE SKIN HOOK (HAND HELD RETRACTORS)	179
LELAND JONES (ATRAUMA CARDIOVASCULAR FORCEPS)	357	MILLIN RETROPUBIC (SELF RETAINING RETRACTORS)	194
LEES (ATRAUMA CARDIOVASCULAR FORCEPS)	366	MAYO-ADSON (SELF RETAINING RETRACTORS)	199
LAMBERT - KAY (ATRAUMA CARDIOVASCULAR FORCEPS)	367	MOLLISON (SELF RETAINING RETRACTORS)	201
LOTION BOWEL (HOLLOW WEARS)	398	MIXSTER (CHOLECYSTECTOMY & GALL STONE)	206
		MOYNIHAN (CHOLECYSTECTOMY & GALL STONE)	206
		MOUAT GALL BLADDER (CHOLECYSTECTOMY & GALL STONE)	206
		MILLS (CHOLECYSTECTOMY & GALL STONE)	207
		MOYNIHAN (GALL DUCT PROBES)	208
		McGEE LATERL (VAGINAL SPECULUM)	222
		MATHIEU (VAGINAL SPECULUM)	225
		MODIFEID WERTHEIM (VAGINAL SPECULUM)	225
		MODIFEID DOYEN (VAGINAL SPECULUM)	226
		MARTIN (UTERINE DILATORS / PROBES)	228
		MUSEUX (TENACULUM FORCEPS)	232
		MCLINTOCK (OVUM FORCEPS)	233
		McLEAN-TUCKER-LUIKART (OBSTETRIC INSTRUMENTS)	252
		MIKULICZ (PERITONEUM INSTRUMENTS)	258
		MAINGOT (HYSTERECTOMY CLUMPS)	260

M

MAYO (SCISSORS)	09	MAYO (SUPER CUT SCISSORS)	35
MAYO HARRINGTON (SCISSORS)	10	McIndoe (SUPER CUT SCISSORS)	35
MAYO STILLE (SCISSORS)	10	MAINGOT INTESTINAL (SERRATED DISSECTING FORCEPS)	40
METZENBAUM (SCISSORS)	11	MACINDOE (DELICATE DISECTING FORCEPS)	41
MCINDOE SCISSORS (SCISSORS)	21	MICINDOE (TOOTHED DISSECTING FORCEPS)	44
MAYO DISSECTING ("TC" SCISSORS)	23	MUSTARDE (TOOTHED DISSECTING FORCEPS)	47
METZENBAUM ("TC" SCISSORS)	24	MICRO SOFT TOUCH RING TIP (SPLINTER FORCEPS)	48
MAYO-LEXER ("TC" SCISSORS)	27	MICRO ADSON (DISSECTING & LIGATURE FORCEPS)	52
MAYO ("TC" SCISSORS)	29	MERIAM ("TC" DISSECTING FORCEPS)	53
METZENBAUM DELICATE ("TC" SCISSORS)	29	MAGILL CATHETER INTRODUCING (PREPARATION INSTRUMENTS)	62
METZENBAUM ("TC" SCISSORS)	30	MAYO (TOWEL CLAMPS)	64
MAYO-LEXER ("TC" SCISSORS)	31	MOYNIHAN (TOWEL CLAMPS)	64
METZENBAUM ("TC" SCISSORS)	32	MAYO SAFETY (SAFETY PIN FORCEPS HOLDERS)	65
MCINDOE SCISSORS ("TC" SCISSORS)	32	MAYO (HAEMOSTATS FORCEPS)	75
METZENBAUM ("TC" SCISSORS)	33	MOYNIHAN (HAEMOSTATS FORCEPS)	83
METZENBAUM (SUPER CUT SCISSORS)	35	MIXTER (HAEMOSTATS FORCEPS)	83
		MICRO ADSON (DISSECTING & LIGATURE FORCEPS)	85
		MIXTER (DISSECTING & LIGATURE FORCEPS)	87
		MAYO (DUNHILL) (NEEDLE HOLDERS)	93
		MAYO (BAUMGARTNER) (NEEDLE HOLDERS)	97
		MATHIEU (NEEDLE HOLDERS)	98
		MAYO (NEEDLE HOLDERS)	99
		MCPHAILS (NEEDLE HOLDERS)	99
		MASING ("TC" NEEDLE HOLDERS)	101
		MAYO ("TC" NEEDLE HOLDERS)	107
		MAYO-HEGAR ("TC" NEEDLE HOLDERS)	108
		MASSON ("TC" NEEDLE HOLDERS)	110
		MATHIEU ("TC" NEEDLE HOLDERS)	112
		MEYHOEFER (OPHTHALMOLOGY)	123
		MYRTLE LEAF PROBE (PROBES)	137
		MACDONALD (DISSECTORS)	140
		MICHEL (SUTURE INTERUMENTS)	144
		MILLIN NEEDLE (SUTURE INTERUMENTS)	145
		MORRIS (HAND HELD RETRACTORS)	155
		MIDDELDORPF (HAND HELD RETRACTORS)	158
		MOYNIHAN (HAND HELD RETRACTORS)	159
		MCINDOE SKIN HOOK (RETRACTORS)	178
		MCINDOE SKIN HOOK (HAND HELD RETRACTORS)	179
		MILLIN RETROPUBIC (SELF RETAINING RETRACTORS)	194
		MAYO-ADSON (SELF RETAINING RETRACTORS)	199
		MOLLISON (SELF RETAINING RETRACTORS)	201
		MIXSTER (CHOLECYSTECTOMY & GALL STONE)	206
		MOYNIHAN (CHOLECYSTECTOMY & GALL STONE)	206
		MOUAT GALL BLADDER (CHOLECYSTECTOMY & GALL STONE)	206
		MILLS (CHOLECYSTECTOMY & GALL STONE)	207
		MOYNIHAN (GALL DUCT PROBES)	208
		McGEE LATERL (VAGINAL SPECULUM)	222
		MATHIEU (VAGINAL SPECULUM)	225
		MODIFEID WERTHEIM (VAGINAL SPECULUM)	225
		MODIFEID DOYEN (VAGINAL SPECULUM)	226
		MARTIN (UTERINE DILATORS / PROBES)	228
		MUSEUX (TENACULUM FORCEPS)	232
		MCLINTOCK (OVUM FORCEPS)	233
		McLEAN-TUCKER-LUIKART (OBSTETRIC INSTRUMENTS)	252
		MIKULICZ (PERITONEUM INSTRUMENTS)	258
		MAINGOT (HYSTERECTOMY CLUMPS)	260

INDEX

RUMEL-BELMONT (NERVE HOOKS, TOURNIQUETS)	385	STILLE-RUSKIN (BONE RONGEURS)	319
RICHES FORCEPS (MONOPOLAR CABLES)	404	SARGENT (BONE RONGEURS)	319
S			
SILVER (SKIN GRAFTING KNIVES)	07	STAMM (BONE CUTTING FORCEPS)	324
STRABISMUS (DELICATE SCISSORS)	16	STILLE LISTON (BONE CUTTING FORCEPS)	325
STEVENS TENOTOMY (DELICATE SCISSORS)	17	STILLE (BONE & RIB SHEARS)	329
SCHUKNECHT WIRE CUTTING (ORAL SCISSORS)	18	SAUERBRUCH (BONE & RIB SHEARS)	330
SCHUMACHER UMBILICAL (SCISSORS)	21	SANTULLI (ATRAUMA BULLDOG CLAMPS)	344
SURGICAL SCISSORS ("TC" SCISSORS)	22	SIMB (BRONCHUS FORCEPS)	342
STRABISMUS SCISSORS ("TC" SCISSORS)	23	SATINSKY (ATRAUMA CARDIOVASCULAR FORCEPS)	364
SIMS ("TC" SCISSORS)	26	SUBRAMANIAN (ATRAUMA PEDIATRIC CLAMPS)	387
SIMS ("TC" SCISSORS)	32	SEMB (LIGATURE CARRIERS)	390
SIMS ("TC" SCISSORS)	33	STERLIZATION TRAY (STERILIZATION TRAYS)	397
ST MARKS (SERRATED DISSECTING FORCEPS)	40	T	
SILCOCK (DELICATE DISSECTING FORCEPS)	42	TOENNIS - ADSON ("TC" SCISSORS)	25
SILCOCK (TOOTHED DISSECTING FORCEPS)	46	TOENNIS ADSON ("TC" SCISSORS)	30
ST MARKS (TOOTHED DISSECTING FORCEPS)	47	TREVES (TOOTHED DISSECTING FORCEPS)	43
S.SHAPED DELICATE (DISSECTING & LIGATURE FORCEPS)	52	TROELTSCH (Wide) (SPLINTER FORCEPS)	48
SEMKEN ("TC" DISSECTING FORCEPS)	53	TROELTSCH (Wide) (SPLINTER FORCEPS)	48
SEMKEN ("TC" DISSECTING FORCEPS)	53	TUDICHUM (SPLINTER FORCEPS)	48
STILES (ALLIS-THOMS) (TISSUE FORCEPS)	56	TUBING CLAMP (HAEMOSTATS FORCEPS)	84
SCHAEDEL (SAFETY PIN FORCEPS HOLDERS)	65	TUBING CLAMP (TISSUE FORCEPS)	91
SPENCER WELLS (HAEMOSTATS FORCEPS)	79	TOENNIS ("TC" NEEDLE HOLDERS)	116
SCHNIDT TONSIL (TONSIL ARTERY FORCEPS)	82	TRACHEAL HOOK (HAND HELD RETRACTORS)	182
S.SHAPED DELICATE (DISSECTING & LIGATURE FORCEPS)	85	TURNER WARWICK (SELF RETAINING RETRACTORS)	185
SAROT ("TC" NEEDLE HOLDERS)	103	TRAVERS (SELF RETAINING RETRACTORS)	190
SINUS (PROBES)	137	TURNER WARWICK (SELF RETAINING RETRACTORS)	195
SYME TONSIL (RETRACTOR)	143	TRAVERS (SELF RETAINING RETRACTORS)	197
SMALLANEURYSN (ANEURYSM NEEDLES)	146	TILLEY LICHTWITZ (TROCARS)	204
SYME (ANEURYSM NEEDLES)	146	TEALE (TENACULUM FORCEPS)	231
SIMON (HAND HELD RETRACTORS)	171	THOMS-GAYLOR (CERVICAL BIOPSY)	237
SMILLIE (HAND HELD RETRACTORS)	174	TISCHLER-MORGAN (CERVICAL BIOPSY FORCEPS)	239
SENN-MILLAR (HAND HELD RETRACTORS)	177	TOWNSEND (CERVICAL BIOPSY FORCEPS)	240
ST-BRATS MODEL (HAND HELD RETRACTORS)	182	TARNIER (OBSTETRIC INSTRUMENTS)	253
STERNAL / ABDOMINAL (SELF RETAINING RETRACTORS)	189	TRNIER (OBSTETRIC MIDWIFERY)	254
SUPRAPUBIC (TROCARS)	203	TURNER-WARWICK (UROLOGY)	275
SCOOP (GALL STONE SCOOPS / FORCEPS)	210	TURNER-WARWICK METAL (UROLOGY)	276
SETON PRINGLE (INTESTINAL CLAMPS)	216	TURNER-WARWICK (UROLOGY)	277
SCHOEMAKER (INTESTINAL CLAMPS)	217	TURNER-WARWICK (UROLOGY)	278
SIMS (VAGINAL SPECULUM)	223	TINKLER (SUCTION TUBES)	280
SIMON (VAGINAL SPECULUM)	226	TUFNOL MALLET (MALLETS)	306
SIMS (UTERINE DILATORS / PROBES)	228	TROTTER (BONE RONGEURS)	316
SCHROEDER (TENACULUM FORCEPS)	230	TUFFIER (RIB SPREADERS)	335
SCHROEDER (TENACULUM FORCEPS)	231	TUBBS (DILATORS)	380
SOMER (UTERINE ELEVATOR FORCEPS)	235	TURNER WARWICK (MONOPOLAR HANDLES, BLADES, NEEDLE, TURNER, SCISSORS)	405
SHARMAN (CERVICAL BIOPSY)	237	U	
SCHUBERT (CERVICAL BIOPSY FORCEPS)	238	UTERINE (SCISSORS)	13
SCHMARCHER (CERVICAL BIOPSY FORCEPS)	239	UTERINE (SCISSORS)	14
SIMON (UTERINE SCOOPS & CURETTES)	243	UTERINE (SCISSORS)	14
SIMS (UTERINE SCOOPS & CURETTES)	243	US ARMY (HAND HELD RETRACTORS)	169
SIMS (UTERINE CURETTES)	244	UTERINE FLUSHING TUBE (OBSTETRIC INSTRUMENTS)	246
SPACKMANN (GYNECOLOGY INSTRUMENTS)	247	UNNA (DERMATOLOGY INSTRUMENTS)	255
SIMS (UTERINE CANNULAE)	250	UMBILICAL DILATOR (GYNRCOLOGY INSTRUMENTS)	257
SIMPSON (OBSTETRIC INSTRUMENTS)	251	U	
SIMPSON-LUIKART (OBSTETRIC INSTRUMENTS)	252	VOLKMANN (HAND HELD RETRACTORS)	165
SELLHEIM (OBSTETRIC MIDWIFERY)	254	VACUME EXTRACTION (UTERINE CANNULAE)	249
SCHAMBERG (DERMATOLOGY INSTRUMENTS)	255	VERHOEVEN (SUCTION TUBES)	283
SAALFELD (DERMATOLOGY INSTRUMENTS)	255	VOLKMANN (BONE SCOOPS)	299
SAENGER OVUN FORCEPS (GYNRCOLOGY INSTRUMENTS)	257	VERBRUGGE (BONE HOLDING FORCEPS)	311
SIMS RECTAL (PROCTOLOGY)	264	W	
ST GRORGES SEIZING (HAEMORRHOIDAL LIGATORS)	270	WATSON (SKIN GRAFTING KNIVES)	07
SELF CLEARING (SUCTION TUBES)	283	WOODS TONSIL (ORAL SCISSORS)	18
ST THOMAS (BONE LEVERS & ELEVATORS)	287	WHEELER TONSIL (ORAL SCISSORS)	18
SWEDISH MODEL (OSTEOTOMES, CHISELS & GOUGES)	301	WILSON TONSIL (ORAL SCISSORS)	18
SMITH-PETERSON (OSTEOTOMES, CHISELS & GOUGES)	302	WAUGH (DELICATE DISSECTING FORCEPS)	41
SMITH-PETERSON (OSTEOTOMES, CHISELS & GOUGES)	304		
SEQUESTUM (BONE HOLDING FORCEPS)	308		
SEMB (BONE HOLDING FORCEPS)	312		
SYNOVCTOMY RONGEUR (BONE RONGEURS)	315		



INDEX

WAUGH (TOOTHED DISSECTING FORCEPS)	45
WANGENSTEEN ("TC" DISSECTING FORCEPS)	50
WILSON TONSIL (TONSIL ARTERY FORCEPS)	82
WANGENSTEEN (NEEDLE HOLDERS)	94
WRIGHT (NEEDLE HOLDERS)	95
WARD (NEEDLE HOLDERS)	96
WEBSTER (NEEDLE HOLDERS)	99
WAGENSTEEN ("TC" NEEDLE HOLDERS)	108
WERTHEIM ("TC" NEEDLE HOLDERS)	111
WIRE CUTTER ("TC" NEEDLE HOLDERS)	117
WEBER (OPHTHALMOLOGY)	124
WILDER (OPHTHALMOLOGY)	124
WECKER (OPHTHALMOLOGY)	124
WILDER (OPHTHALMOLOGY)	126
WATSON CHEYNE (DISSECTORS)	140
WALTON (HAND HELD RETRACTORS)	163
WERTHEIM (HAND HELD RETRACTORS)	174
WARDS CHEEK (HAND HELD RETRACTORS)	179
WEISLANDER (SELF RETAINING RETRACTORS)	191
WEISLANDER (SELF RETAINING RETRACTORS)	192
WEISLANDER (SELF RETAINING RETRACTORS)	193
WALACE MODIFIED (SELF RETAINING RETRACTORS)	201
WILSON (TENACULUM FORCEPS)	230
WITTNER (CERVICAL BIOPSY FORCEPS)	239
WRIGLEY (OBSTETRICS INSTRUMENTS)	248
WALTON (DERMATOLOGY INSTRUMENTS)	255
WINTER OVUM FORCEPS (DERMATOLOGY INSTRUMENTS)	256
WERTHEIM (HYSTERECTOMY CLUMPS)	261
WERTHEIM (HYSTERECTOMY CLUMPS)	263
WALTON RECTAL (SIGMOIDOSCOPY)	268
WATSLON JONES (BONE LEVERS)	288
WILLIGER (BONE LEVERS)	292
WILLIGER (BONE LEVERS & RASPATORIES)	293
WILMS (BONE RONGEURS)	316
WARD (BONE CUTTING FORCEPS)	326
WEBER (ATRAUMA CARDIOVASCULAR FORCEPS)	363
WILSON HEY FORCEPS (MONOPOLAR CABLES)	404

Y

YEOWMAN BIOPSY (PROCTOLOGY HAEMORRHOIDAL)	269
YANKAUER (SUCTION TUBES)	280

Z

ZWEIFIL ("TC" NEEDLE HOLDERS)	114
ZOELLNER (SUCTION TUBES)	284
ZAUFAL-JANSEN (BONE RONGEURS)	318

SURGICAL

Instruments Catalogue

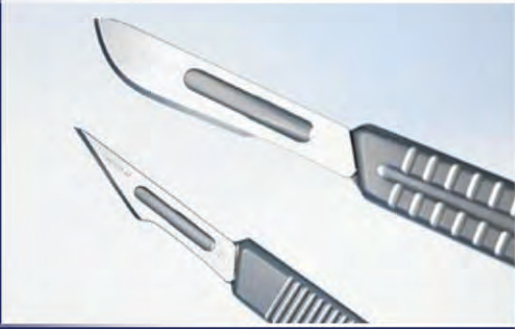

Design & Printed:
House of Catalogue
Tel: 052-4581636, 4612006, 7
www.houseofcatalogue1.com

SURGICAL INSTRUMENTS